

**MITSUBISHI  
ELECTRIC**

*Changes for the Better*

SERVO AMPLIFIERS & MOTORS

for a greener tomorrow



MITSUBISHI SERVO AMPLIFIERS & MOTORS

# MELSERVO JE





Apply servos to all machines with

### **Easy To Use**

#### **Advanced One-Touch Tuning**

Servo gains are adjusted with one-touch ease without a personal computer.

#### **Tolerance against Instantaneous Power Failure**

The instantaneous power failure tough drive function and the large capacity capacitor reduce machine downtime.

#### **Large Capacity Drive Recorder**

Servo data before and after the alarm occurrence are stored in non-volatile memory for quick and accurate analysis of the alarm occurrence.

MITSUBISHI SERVO AMPLIFIERS & MOTORS

# MELSERVO JE

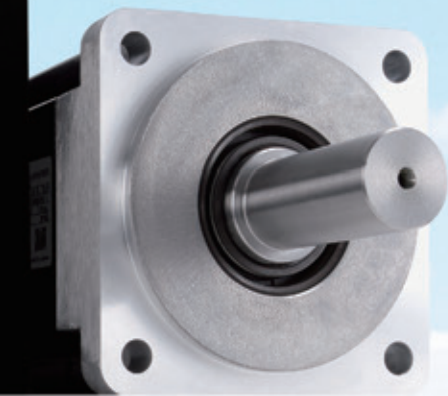

reliable basic performance and advanced ease-of-use!

## High Performance

### Fast and Accurate

The dedicated engine enables speed frequency response of 2.0 kHz, shortening the tact time.

### High Resolution Encoder

The servo motor is equipped with 131072 pulses/rev (17-bit) incremental encoder, achieving high accuracy.

### Energy Conservation

The large capacity main circuit capacitor allows the regenerative energy to be used effectively, reducing energy consumption.

## Global Standard

### Compliance to Global Standards

Global servo, MR-JE series, complies with global standards as standard.

### Sink and Source Connections

Command pulse input and digital input/output are compatible with both sink and source type connections.

### Global Support

FA Centers located throughout the world provide attentive services to support users.

# With Mitsubishi's commitment to total system solutions the MELSERVO-JE becomes the answer to the world-wide

To satisfy your needs of advanced driving control systems, Mitsubishi Electric provides an extensive range of automation and servo motors to programmable controllers, positioning modules, Human Machine Interfaces and highly developed. With our global support network which provides attentive services including product purchases, after-sales services, we assure you the maximum performance of MELSERVO-JE throughout the world.

## HUMAN MACHINE I/F

### Graphic Operation Terminal



GOT1000 series

### PC/AT compatible computer



## SOFTWARE



## CONTROLLER

### Programmable controller



MELSEC F series



MELSEC Q series



MELSEC L series

### Positioning module



FX<sub>2N</sub>-10PG  
FX<sub>3U</sub>-1PG



QD75P1/2/4N  
QD75D1/2/4N



QD70P4/8  
QD70D4/8



LD75P1/2/4  
LD75D1/2/4

## INTERFACE

### Pulse train input

## SERVO AMPLIFIER

### Servo amplifier



General-purpose interface compatible

MR-JE-A

## LOW-VOLTAGE SWITCH

## SERVO MOTOR

### Servo motor



Small capacity,  
low inertia  
**HF-KN series**  
Capacity: 100 to 750 W



Medium capacity,  
medium inertia  
**HF-SN series**  
Capacity: 0.5 to 3 kW

## SOLUTION



## LINEUP

### Servo amplifier

●: Compatible

Model	Power supply specifications	Rated output [kW]	Command interface		Control mode		
			Pulse train	Analog voltage	Position	Speed	Torque
MR-JE-_A	3-phase 200 V AC	0.1, 0.2, 0.4, 0.6, 0.75, 1, 2, 3	●	●	●	●	●

### Servo motor

Series	Rated speed [r/min]
HF-KN series	3000
HF-SN series	2000

\*1. The maximum speed of HF-SN302J



and global supports,  
needs in driving control.

products from servo amplifiers  
solutions.  
technical consulting, and practical training,

PLC engineering software — **MELSOFT GX Works2**

Servo setup software — **MELSOFT MR Configurator2**

**Capacity selection software**

**GEAR**

**Magnetic  
contactor**



**MS-T**

**Molded-case  
circuit breaker**



**WS-V**

Mitsubishi Electric's integrated FA solution for achieving seamless information collaboration between information systems and control systems, and enabling lateral integration of production sites.

Mitsubishi Electric's integrated FA platform for achieving lateral integration of controllers & HMI, engineering environments and networks at production sites.

●: Available

Maximum speed [r/min]	Rated output [kW]	With electro-magnetic brake (B)	Oil seal (J)	IP rating*2
4500	0.1, 0.2, 0.4, 0.75	●	●	IP65
3000/2500*1	0.5, 1, 1.5, 2, 3	●	●	IP67

\*1 is 2500 r/min. \*2. The shaft-through portion is excluded.

**INDEX**

**Easy To Use**

- Easy Adjustments ..... p. 5
- Improved Tolerance against Instantaneous Power Failure ..... p. 6
- Maintenance Functions ..... p. 7
- Servo Motors ..... p. 8
- Servo Setup Software (MR Configurator2) ..... p. 9

**High Performance**

- Fast and Accurate ..... p. 11
- Energy Conservation ..... p. 12

**Global Standard**

- Global Standards ..... p. 13
- Global FA Centers ..... p. 14

**Product Specifications**

- Servo Amplifiers ..... p. 1-1
- Servo Motors ..... p. 2-1
- Options/Peripheral Equipment ..... p. 3-1
- LVS/Wires ..... p. 4-1
- Product List ..... p. 5-1
- Cautions ..... p. 6-1



# Easy To Use



## Fast, Trouble-Free Setup

Mitsubishi Electric's unique "Advanced one-touch tuning" enables servo gain adjustment with one-touch ease. The improved tolerance against instantaneous power failure, the ease of maintenance, and the simple setup software would add further usability for all MELSERVO-JE users.

MITSUBISHI  
MELSERVO-JE

## High-Precision Tuning

### Servo gain adjustment with one-touch ease

### Advanced One-Touch Tuning Function

Servo gains including machine resonance suppression filter, advanced vibration suppression control II\*, and robust filter are adjusted just by pressing the buttons on the front of the servo amplifier. Machine performance is utilized to the fullest using the advanced vibration suppression control function.

\* The advanced vibration suppression control II automatically adjusts one frequency.

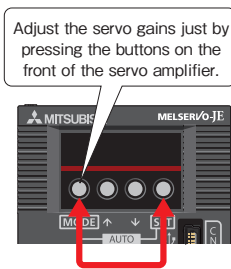

— : Command — : Actual operation

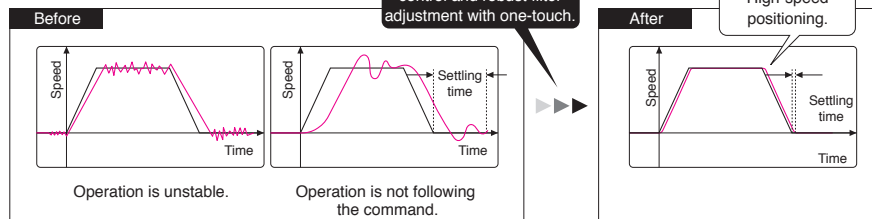

### Suppress two types of low frequency vibrations at once

### Advanced Vibration Suppression Control II

Patent pending

Due to vibration suppression algorithm which supports three-inertia system, two types of low frequency vibrations are suppressed at the same time. Adjustment is performed on MR Configurator2.

This function is effective in suppressing vibration at the end of an arm and in reducing residual vibration in a machine.

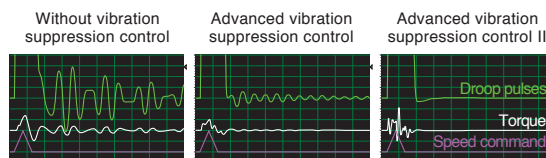
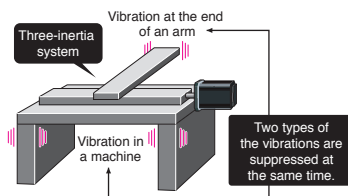



### Applicable frequency range of 10 Hz to 4500 Hz

## Machine Resonance Suppression Filter

With advanced filter structure, applicable frequency range is expanded to between 10 Hz and 4500 Hz. Additionally, the number of simultaneously applicable filters is increased to five, improving vibration suppression performance of machines.

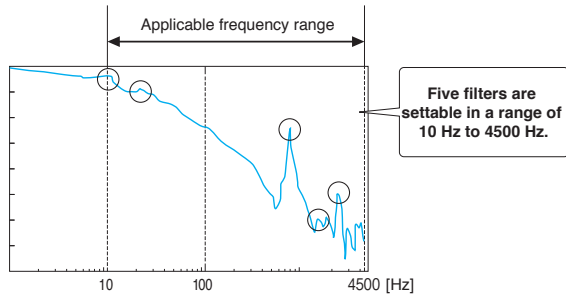

### High responsivity and stability for high-inertia machines

## Robust Filter

Patent pending

Achieving both high responsivity and stability was difficult with the conventional control in high-inertia systems with belts and gears such as printing and packaging machines. The MR-JE series enables the high responsivity and the stability at the same time without adjustment. The robust filter more gradually reduces the torque with wide frequency range and achieves more stability as compared to the prior model.

Machine with a high-inertia ratio

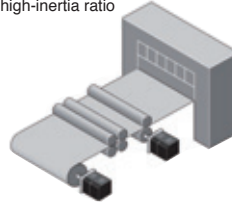

Robust filter

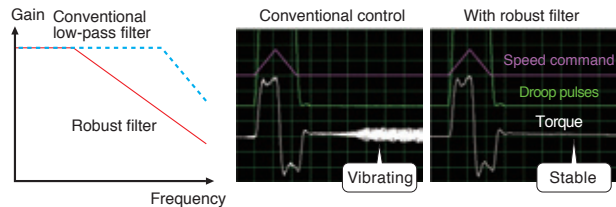

## Increased Tolerance Against Instantaneous Power Failure

### Reduce machine downtime

Capacity is increased by 20%

## Large Capacity Main Circuit Capacitor

The tolerance against instantaneous power failure is improved by increasing the capacity of the main circuit capacitor by 20% as compared to the prior model. The improved tolerance reduces machine downtime and then improves productivity.

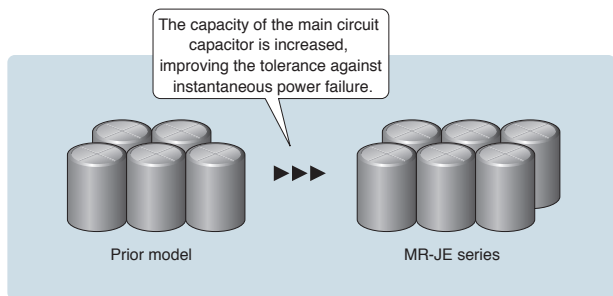

### Reduce undervoltage alarms

## Instantaneous Power Failure Tough Drive

The possibility of undervoltage alarm is reduced by limiting the torque when instantaneous power failure is detected in the main circuit power supply.

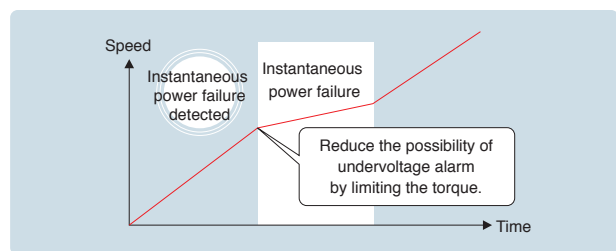

## Analyze cause of alarm

## Large Capacity Drive Recorder

Patent pending

- Servo data such as motor current and position command before and after the alarm occurrence are stored in non-volatile memory of the servo amplifier. The data read on MR Configurator2 during restoration are used for cause analysis.
- This function allows to check the waveform of 16 alarms in the alarm history ((analog 16 bits × 7 channels + digital 8 channels) × 256 points) and the monitor value.

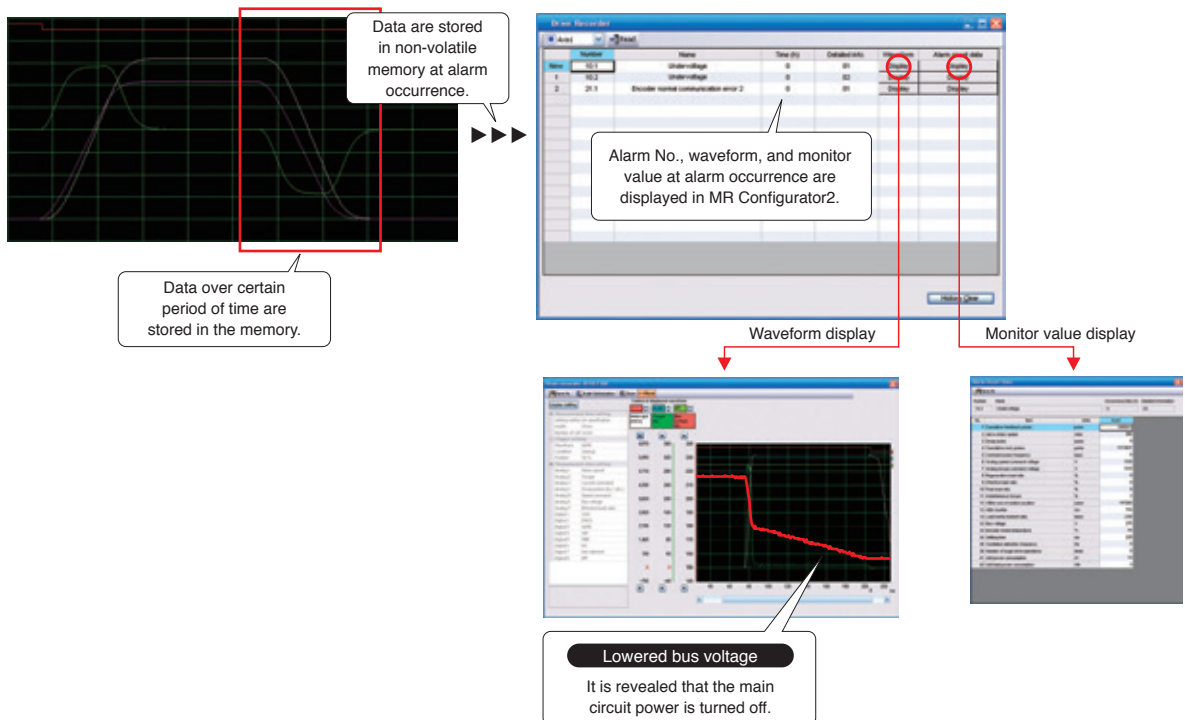

## Reduce machine downtime incurred by age-related deterioration

## Vibration Tough Drive

Machine resonance suppression filter is readjusted when vibration caused by a change in machine resonance frequency is detected by the current command inside the servo amplifier. This function reduces losses from the machine downtime caused by age-related deterioration.

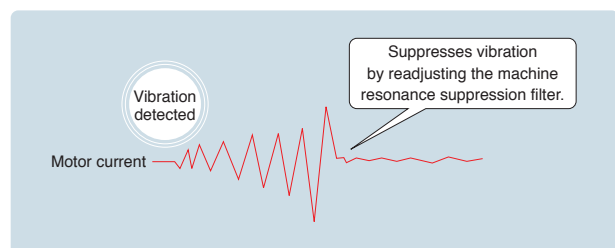



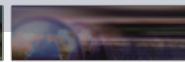
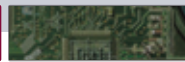
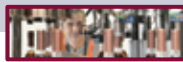

### Support optimal maintenance of driving parts

## Machine Diagnosis Function

Patent pending

This function detects changes of machine parts (ball screw, guide, bearing, belt, etc.) by analyzing machine friction, load moment of inertia, unbalanced torque, and changes in vibration component from the data inside the servo amplifier, supporting timely maintenance of the driving parts.

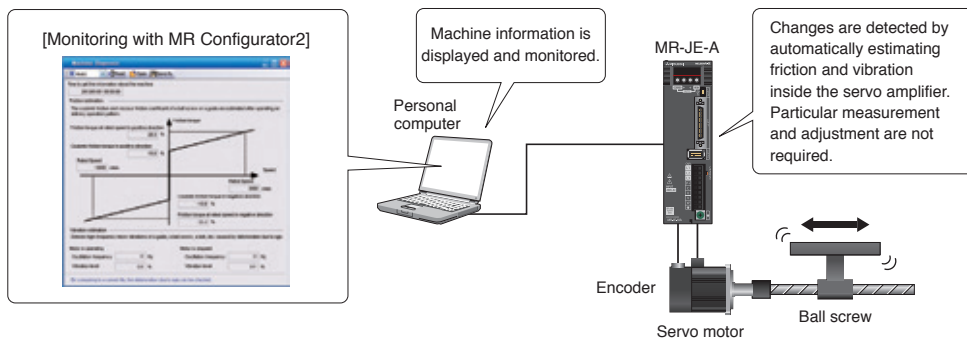

### Easy troubleshooting

## Three-Digit Alarm

MR-JE series displays the alarm No. in three digits to show the servo alarm in more details, making troubleshooting easy.

[Example of an alarm window on MR Configurator2]

[Three-digit alarm display]

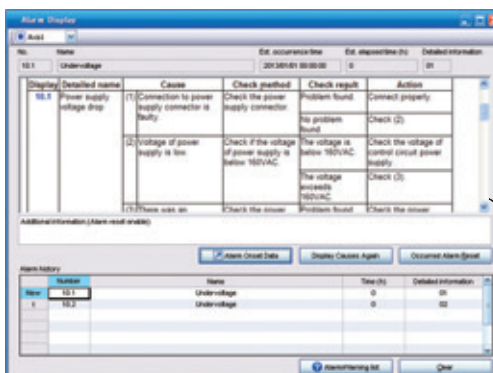

The alarm No. shows whether the undervoltage alarm was caused by instantaneous power failure or by lowered bus voltage in the servo amplifier.

### Even in severe environment

## Improved Environment Safety

HF-KN series and HF-SN series are rated IP65 and IP67 respectively.

\* The shaft-through portion is excluded.

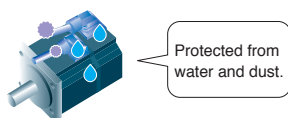

### Cable leading in both ways

## Selectable Cable Leading Direction

The power cable, the encoder cable, and the electromagnetic brake cable are led out to either in direction of or in opposite direction of the load side, depending on the selected cables. (HF-KN series)

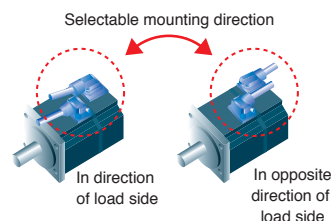

The easy-to-use design MR-JE series makes startup and adjustment that simple.

Servo setup software

# MR Configurator2 (SW1DNC-MRC2-E)

Tuning, monitor display, diagnosis, reading/writing parameters, and test operations are easily performed on a personal computer.

This start-up support tool achieves a stable machine system, optimum control, and short setup time.



## MELSER/o-JE Preparation

Just follow the guidance, and setup is complete

### Servo Assistant Function

Complete setting up the servo amplifier just by following guidance displays. Setting parameters and tuning are easy since related functions are called up from shortcut buttons.

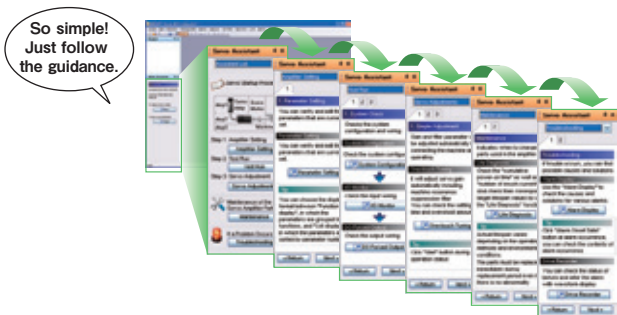

Supporting replacement from conventional system

### Parameter Converter Function

With this function, parameter files for MR-E series or MR-E Super series are converted to those for MR-JE series.

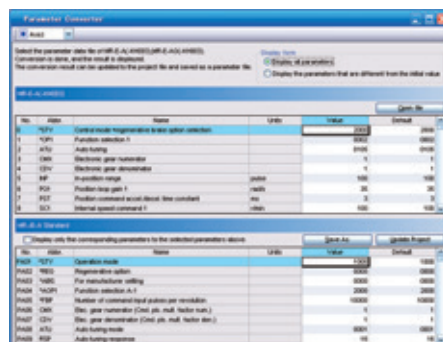

## MELSER/o-JE Setting and Start-up

Easy and fast parameter setting

### Parameter Setting Function

Display parameter setting in list or visual formats, and set parameters by selecting from the drop down list. Set in-position range in mechanical system unit (e.g.  $\mu\text{m}$ ). Parameter read/write time is approximately one tenth of the conventional time.

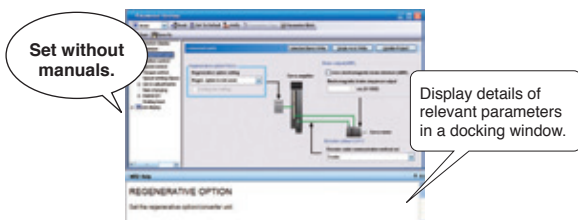

Visible operation status and power consumption

### Monitor Function

Monitor operation status on the [Display all] window. Check power consumption without any measurement equipment such as electric power meter, assign input/output signals, and monitor ON/OFF status on the [I/O monitor] window.

[Display all] window

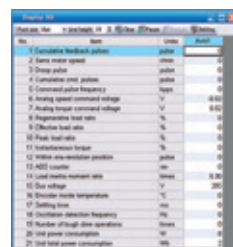

[I/O monitor] window



Monitor without measurement equipment.

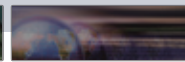
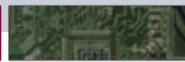

# Servo Adjustment

Tuning is just one click away

## One-Touch Tuning Function

Adjustments including estimating load to motor inertia ratio, adjusting gain, and suppressing machine resonance are automatically performed for the maximum servo performance just by clicking the start button. Check the adjustment results of settling time and overshoot.

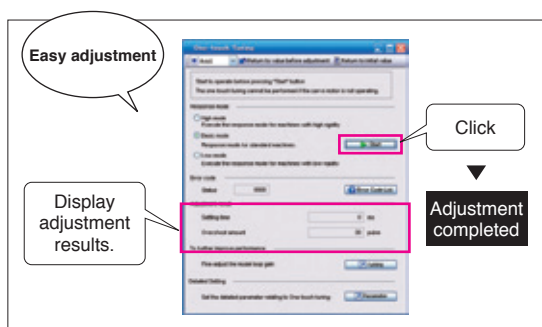

Fine tuning of loop gain

## Tuning Function

Manually adjust loop gain finely on the [Tuning] window for further performance after the one-touch tuning.

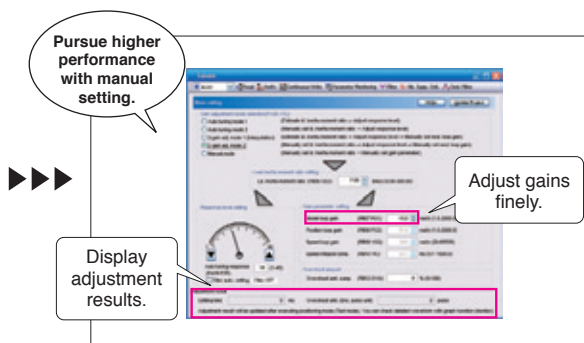

More convenient with overwrite and graph history functions

## Graph Function

The number of measurement channels is increased to 7 channels for analog, and 8 channels for digital. Display various servo statuses in the waveform at one measurement, supporting setting and adjustment. Convenient functions such as [Overwrite] for overwriting multiple data and [Graph history] for displaying graph history are available.



Analyze the frequency characteristics

## Machine Analyzer Function

Input random torque to the servo motor automatically and analyze frequency characteristics (0.1 Hz to 4.5 kHz) of a machine system just by clicking the [Start] button. This function supports setting of machine resonance suppression filter, etc.

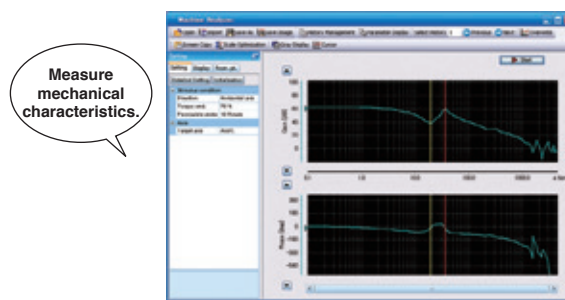

# Maintenance

For timely parts replacement

## Servo Amplifier Life Diagnosis Function

Check cumulative operation time and on/off times of inrush relay. This function provides an indication of replacement time for servo amplifier parts such as capacitor and relays.

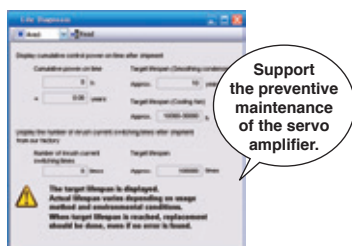

Find out the aging deterioration of your machines

## Machine Diagnosis Function

Patent pending

This function estimates and displays machine friction and vibration in normal operation without any special measurement. Comparing the data of the first operation and after years of operation helps to find out the aging deterioration of a machine and is beneficial for preventive maintenance.

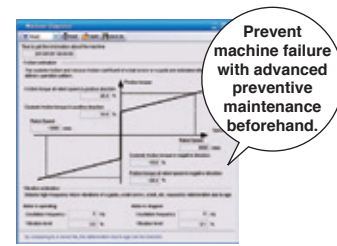

# High Performance

MITSUBISHI SERVO AMPLIFIERS & MOTORS  
**MELSERVO-JE**



## Further Reduction of Tact Time

Top-level basic performance is achieved, including speed frequency response of 2.0 kHz. The MELSERVO-JE series that utilizes regenerative energy maximizes the machine performance and energy saving.

MELSERVO-JE

Fast and Accurate

### Class top-level speed frequency response

#### 2.0 kHz Speed Frequency Response

The top-level speed frequency response of 2.0 kHz shortens the settling time substantially, reducing the tact time of a machine.

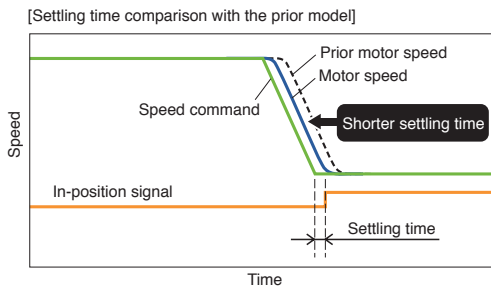

### Exact positioning

#### High-Resolution Encoder

The servo motor equipped with an incremental encoder of 131072 pulses/rev (17-bit) enables high-accuracy positioning and smooth rotation.

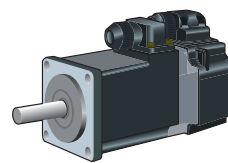

Equipped with high-resolution incremental encoder.

### Further smooth operation

#### Max Command Pulse Frequency of 4 Mpps

MR-JE-A having a general-purpose interface is compatible with the maximum command pulse frequency of 4 Mpps, enabling smooth operation.

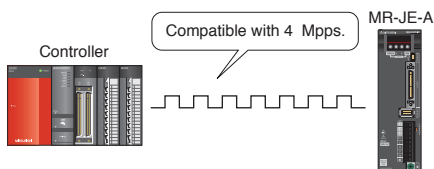

### Smooth, constant-speed operation

#### Reduced Torque Ripple during Conduction

By optimizing the combination of the number of motor poles and the number of slots, torque ripple during conduction is greatly reduced. Smooth constant-velocity operation of a machine is achieved.

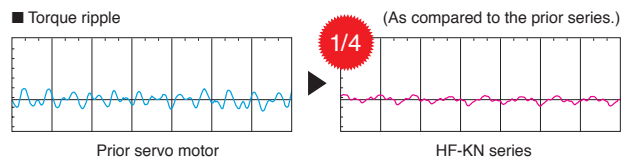

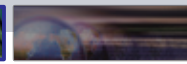
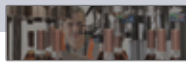

### Compatible with pulse train and analog

## Flexible Command Interface

The command interface of MR-JE-A is compatible with both pulse train command and analog voltage command. The MR-JE-A servo amplifier enables positioning control with pulse train command, and speed and torque control with analog voltage command.

### Reduce waste in energy consumption

## Efficient Utilization of Regenerative Energy

Capacity of the main circuit capacitor is increased by 20% as compared to that of the prior model, and thus the charging capacity is increased, enabling larger regenerative energy to be reused as driving power energy. Additionally, because the control circuit and the main circuit use a common power supply, the regenerative energy is also used for the control circuit, reducing waste in energy consumption.

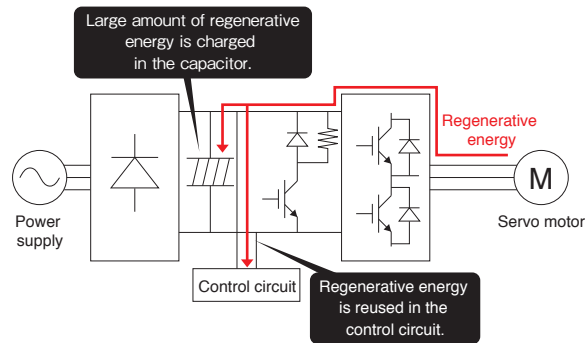

### Visualize power consumption

## Power Monitor

Driving power and regenerative energy are calculated in the servo amplifier from the data such as speed and current, and the power consumption is monitored with MR Configurator2. Visualization of the power consumption helps to save energy.

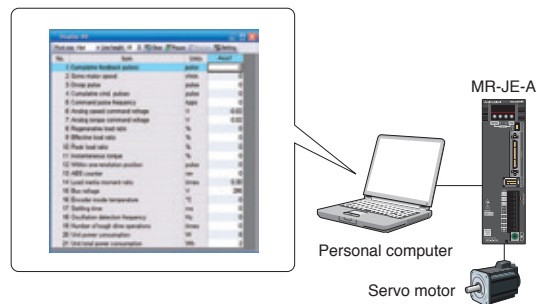

### Achieve further energy saving

## Saving Energy with Advanced Technologies

### Reducing energy loss of the servo amplifier

Efficiency is increased by the use of a new power module. Energy loss of the servo amplifier itself is reduced.

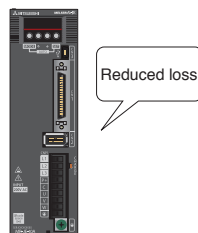

### Saving energy by improving machine performance

Configuring a driving system with the high-performance MR-JE series servo amplifiers and servo motors reduces machine tact time and operation time, achieving energy conservation.

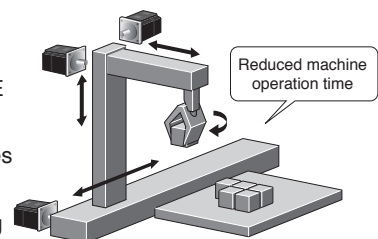

# Global Standard

MITSUBISHI SERVO AMPLIFIERS & MOTORS  
**MELSERVO-JE**



## Fully Compliant Worldwide

To satisfy growing needs in driving control throughout the world, the MR-JE series complies with global standards.

Additionally, the command pulse input and the digital input/output are compatible with both sink and source type connections.

MELSERVO-JE

Global Servo Meets Global Standards

Best quality all over the world

### Conformity with Global Standards and Regulations

Use the MR-JE series globally. The servo amplifiers and the servo motors conform to global standards as standard.

#### Conformity with global standards and regulations



		Servo amplifier	Servo motor
European EC directive	Low voltage directive	EN 61800-5-1	EN 60034-1 / EN 60034-5
	EMC directive	EN 61800-3	EN 60034-1
	RoHS directive	Compliant	Compliant
UL standard		UL 508C	UL 1004-1 / UL 1004-6
CSA standard		CSA C22.2 No.14	CSA C22.2 No.100
Measures for Administration of the Pollution Control of Electronic Information Products (Chinese RoHS)		Compliant (optional cables and connectors)	Compliant (optional cables and connectors)
China Compulsory Certification (CCC)		N/A	N/A
Korea Radio Wave Law (KC)		Compliant	N/A

\*1. Refer to "Servo Amplifier Instruction Manual" and "EMC Installation Guidelines" when your system needs to meet the EMC directive.  
\*2. When exporting the product, follow the local laws and regulations.

### Flexible connections for the global use

#### Sink and Source Connections

The command pulse input and the digital input/output are compatible with both sink and source type connections.

#### Example of digital input

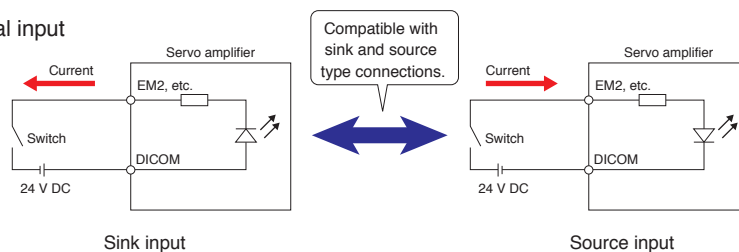



**MELSERVO-JE** Extensive Global Support Network

**Supporting MELSERVO users worldwide**

**Global FA Centers**

Across the globe, FA Centers provide customers with local assistance for purchasing Mitsubishi Electric products and with after-sales services. To enable national branch offices and local representatives to work together in responding to local needs, we have developed a service network throughout the world. We provide repairs, on-site engineering support, and sales of replacement parts. We also provide various services from technical consulting services by our expert engineers to practical training for equipment operations.

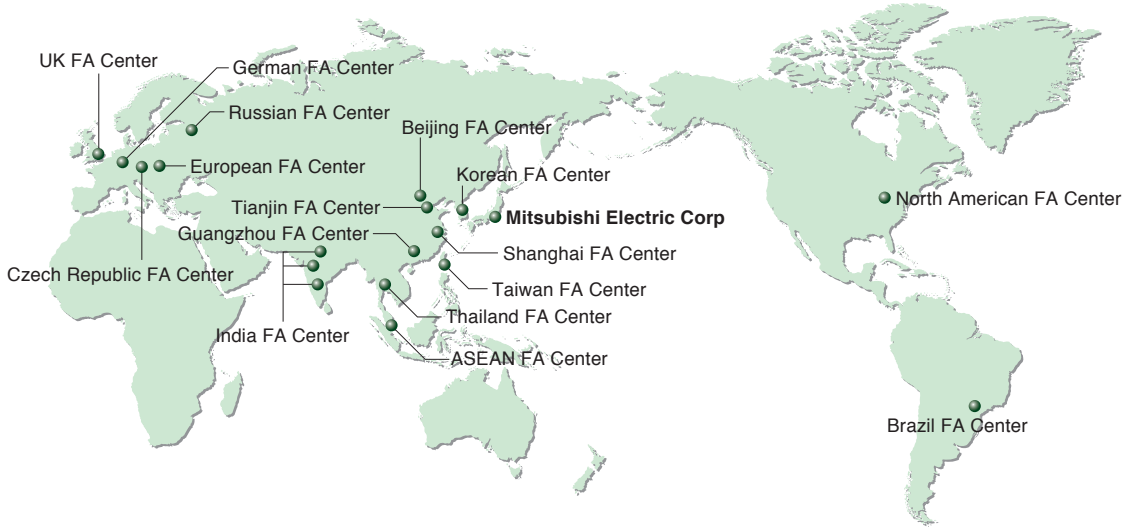

**Shanghai, China**  
Shanghai FA Center



**Taiwan**  
Left: Taiwan FA Center (Taipei) /  
Right: Taiwan FA Center (Taichung)



**Pune/Gurgaon/Bangalore, India**  
India FA Center



**Ratingen, Germany**  
German FA Center/  
Europe Development Center



**Beijing, China**  
Beijing FA Center



**Seoul, Korea**  
Korean FA Center



**Chicago IL, U.S.A.**  
North American FA Center/  
North American Development Center



**Hatfield, U.K.**  
UK FA Center



**Tianjin, China**  
Tianjin FA Center



**Bangkok, Thailand**  
Thailand FA Center



**Sao Paulo SP, Brazil**  
Brazil FA Center



**Praha, Czech Republic**  
Czech Republic FA Center



**Guangzhou, China**  
Guangzhou FA Center



**Singapore**  
ASEAN FA Center



**Krakowska, Poland**  
European FA Center (Poland)



**St. Petersburg, Russia**  
Russian FA Center

MEMO

---



# 1

Model Designation.....	1-1
Combinations of Servo Amplifier and Servo Motor .....	1-1
Connections with Peripheral Equipment.....	1-2
Specifications .....	1-3
Standard Wiring Diagram Example .....	1-4
Power Supply Connection Example .....	1-8
Servo Motor Connection Example.....	1-9
Dimensions.....	1-10

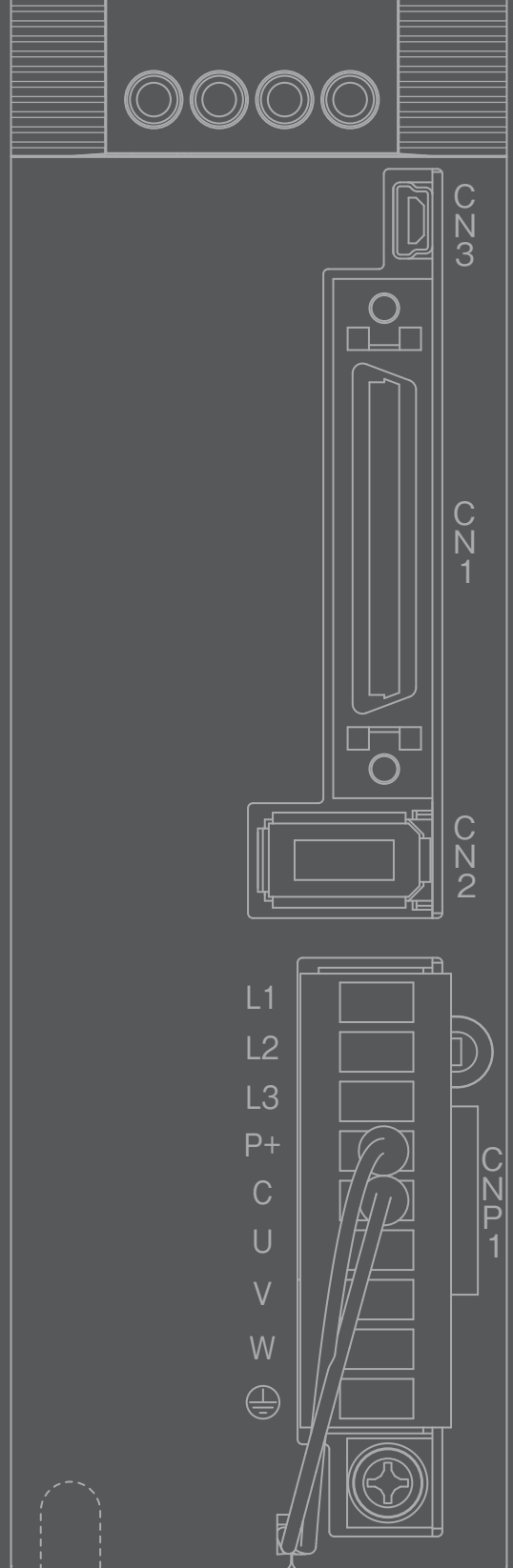

## Servo Amplifiers

## Servo Amplifier Model Designation

MR-JE-10A

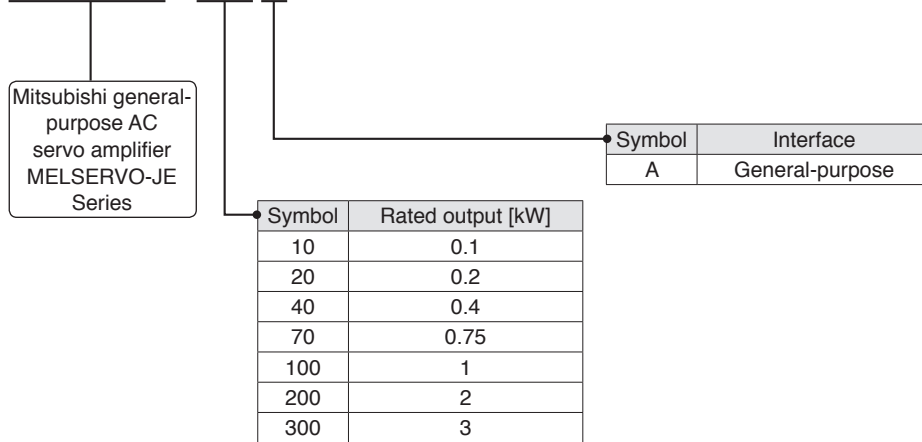

## Combinations of Servo Amplifier and Servo Motor

Servo amplifier	Servo motor	
	HF-KN series	HF-SN series
MR-JE-10A	HF-KN13J	-
MR-JE-20A	HF-KN23J	-
MR-JE-40A	HF-KN43J	-
MR-JE-70A	HF-KN73J	HF-SN52J
MR-JE-100A	-	HF-SN102J
MR-JE-200A	-	HF-SN152J, HF-SN202J
MR-JE-300A	-	HF-SN302J



## MR-JE-A Connections with Peripheral Equipment (Note 1)

Peripheral equipment is connected to MR-JE-A as described below. Connectors, cables, options, and other necessary equipment are available so that users can set up the servo amplifier easily and start using it right away.

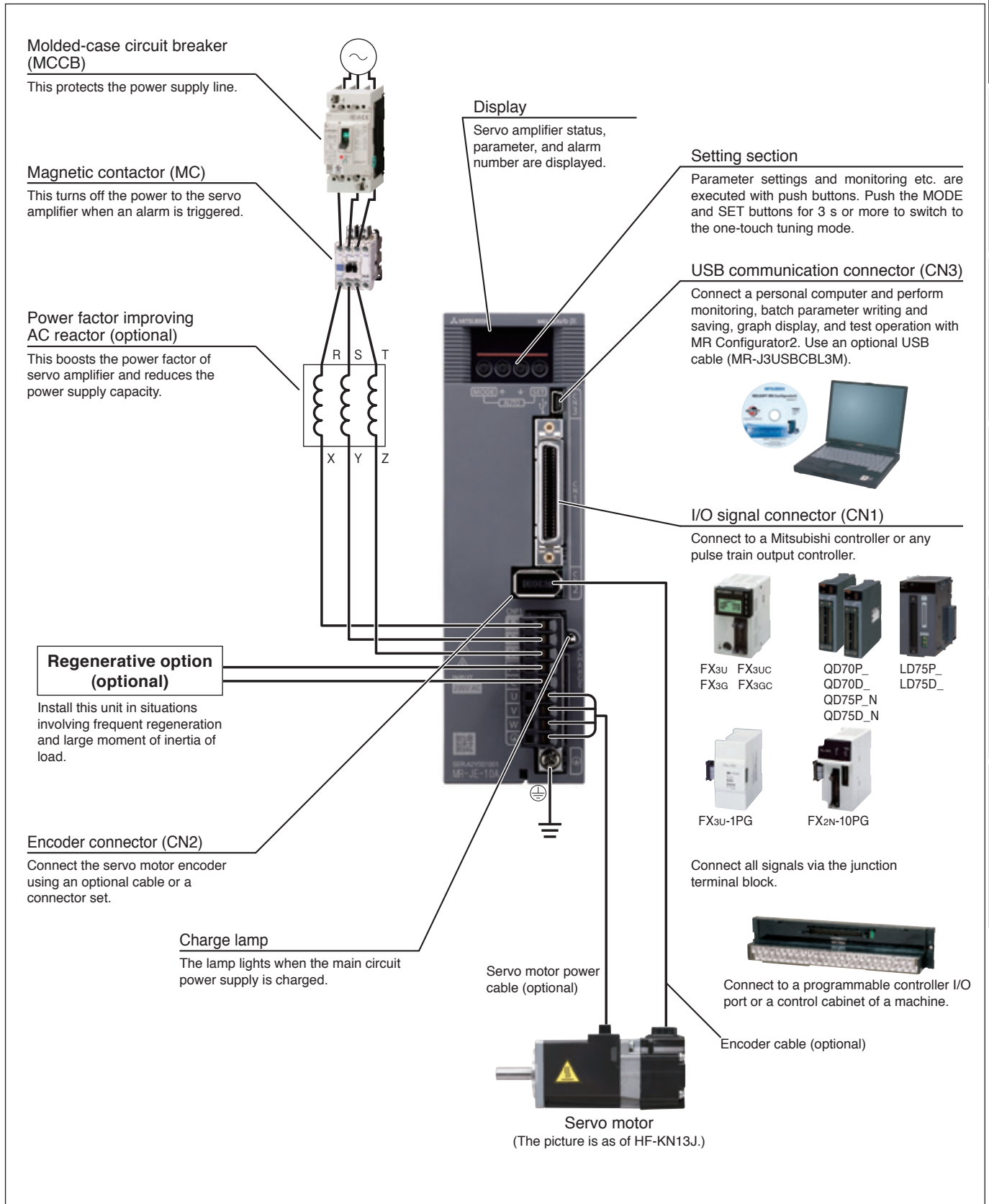

Notes: 1. The connection with the peripheral equipment is an example for MR-JE-100A or smaller servo amplifier. Refer to "MR-JE\_ A Servo Amplifier Instruction Manual" for the actual connections.

## MR-JE-A (General-Purpose Interface) Specifications

Servo amplifier model MR-JE-		10A	20A	40A	70A	100A	200A	300A
Output	Rated voltage	3-phase 170 V AC						
	Rated current [A]	1.1	1.5	2.8	5.8	6.0	11.0	11.0
Power supply input	Voltage/frequency (Note 1)	3-phase or 1-phase 200 V AC to 240 V AC, 50 Hz/60 Hz				3-phase 200 V AC to 240 V AC, 50 Hz/60 Hz		
	Rated current [A]	0.9	1.5	2.6	3.8	5.0	10.5	14.0
	Permissible voltage fluctuation	3-phase or 1-phase 170 V AC to 264 V AC				3-phase 170 V AC to 264 V AC		
	Permissible frequency fluctuation	±5% maximum						
Interface power supply		24 V DC ± 10% (required current capacity: 0.3 A)						
Control method		Sine-wave PWM control/current control method						
Tolerable regenerative power of the built-in regenerative resistor (Note 2, 3) [W]		-	-	10	20	20	100	100
Dynamic brake		Built-in (Note 4)						
Communication function		USB: Connect a personal computer (MR Configurator2 compatible)						
Encoder output pulse		Compatible (A/B/Z-phase pulse)						
Analog monitor		2 channels						
Position control mode	Maximum input pulse frequency	4 Mpps (when using differential receiver), 200 kpps (when using open-collector)						
	Positioning feedback pulse	Encoder resolution: 131072 pulses/rev						
	Command pulse multiplying factor	Electronic gear A/B multiple, A: 1 to 16777215, B: 1 to 16777215, 1/10 < A/B < 4000						
	Positioning complete width setting	0 pulse to ±65535 pulses (command pulse unit)						
	Error excessive	±3 rotations						
	Torque limit	Set by parameters or external analog input (0 V DC to +10 V DC/maximum torque)						
Speed control mode	Speed control range	Analog speed command 1:2000, internal speed command 1:5000						
	Analog speed command input	0 V DC to ±10 V DC/rated speed (Speed at 10 V is changeable with [Pr. PC12].)						
	Speed fluctuation rate	±0.01% maximum (load fluctuation 0% to 100%), 0% (power fluctuation: ±10%) ±0.2% maximum (ambient temperature: 25 °C ± 10 °C) only when using analog speed command						
	Torque limit	Set by parameters or external analog input (0 V DC to +10 V DC/maximum torque)						
Torque control mode	Analog torque command input	0 V DC to ±8 V DC/maximum torque (input impedance: 10 kΩ to 12 kΩ)						
	Speed limit	Set by parameters or external analog input (0 V DC to ± 10 V DC/rated speed)						
Protective functions		Overcurrent shut-off, regenerative overvoltage shut-off, overload shut-off (electronic thermal), servo motor overheat protection, encoder error protection, regenerative error protection, undervoltage protection, instantaneous power failure protection, overspeed protection, error excessive protection						
Compliance to standards		Refer to "Conformity with global standards and regulations" on p. 13 in this catalog.						
Structure (IP rating)		Natural cooling, open (IP20)					Force cooling, open (IP20)	
Close mounting		Possible (Note 5)						
Environment	Ambient temperature	0 °C to 55 °C (non-freezing), storage: -20 °C to 65 °C (non-freezing)						
	Ambient humidity	90 %RH maximum (non-condensing), storage: 90 %RH maximum (non-condensing)						
	Ambience	Indoors (no direct sunlight); no corrosive gas, inflammable gas, oil mist or dust						
	Altitude	1000 m or less above sea level						
	Vibration resistance	5.9 m/s <sup>2</sup> at 10 Hz to 55 Hz (directions of X, Y and Z axes)						
Mass [kg]		0.8	0.8	0.8	1.5	1.5	2.1	2.1

Notes: 1. Rated output and speed of a servo motor are applicable when the servo amplifier, combined with the servo motor, is operated within the specified power supply voltage and frequency.

2. Select the most suitable regenerative option for your system with our capacity selection software.

3. Refer to "Regenerative Option" in this catalog for the tolerable regenerative power [W] when regenerative option is used.

4. When using the built-in dynamic brake, refer to "MR-JE- A Servo Amplifier Instruction Manual" for the permissible load to motor inertia ratio.

5. When the servo amplifiers are closely mounted, keep the ambient temperature within 0 °C to 45 °C, or use them with 75% or less of the effective load ratio.



## MR-JE-A Standard Wiring Diagram Example: Position Control Operation

### Connecting to FX<sub>3U</sub> (position servo, incremental)

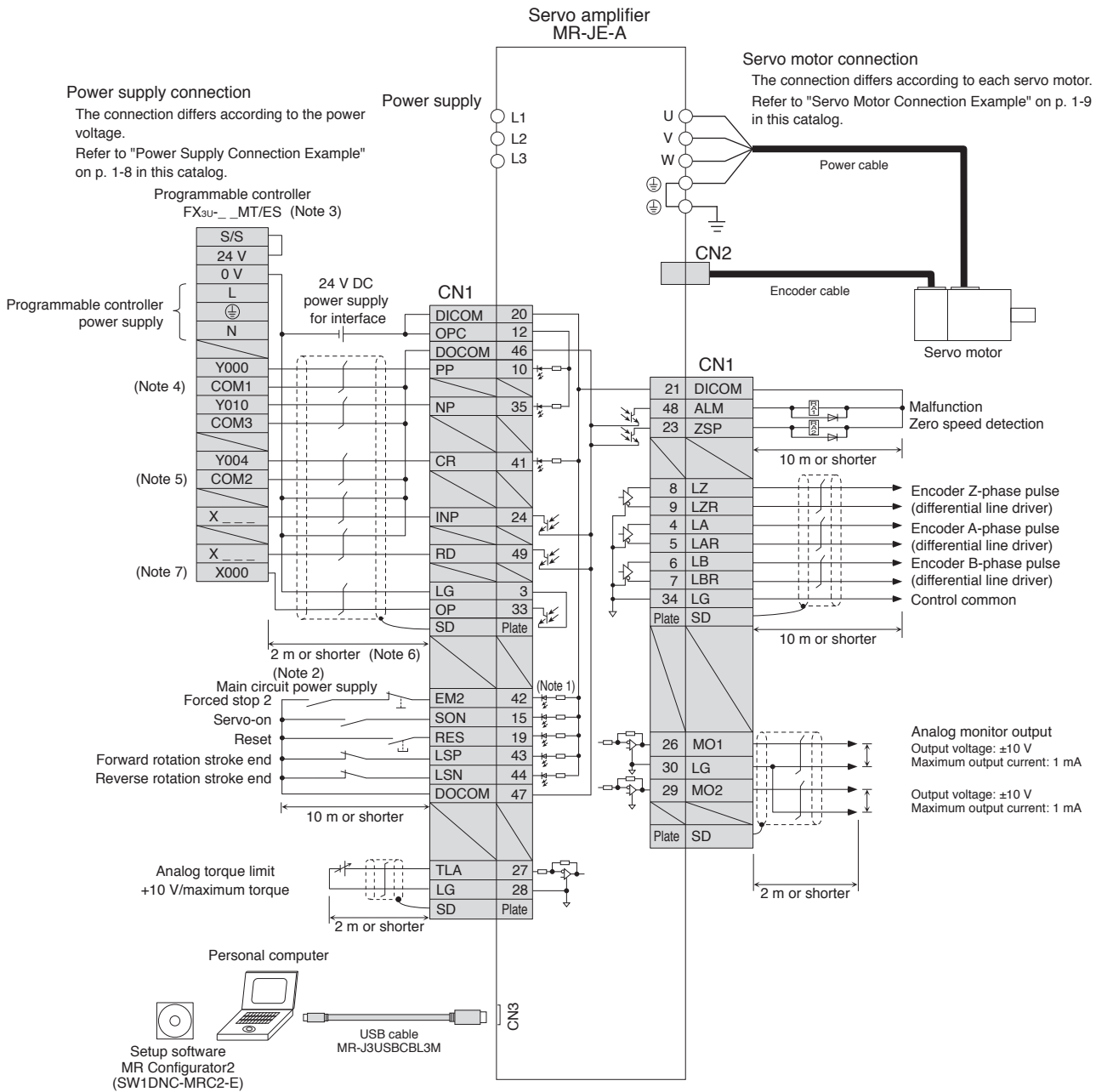

- Notes: 1. This is for sink wiring. Source wiring is also possible.  
2. Create a circuit to turn off EM2 when the main circuit power is turned off to prevent an unexpected restart of the servo amplifier.  
3. Select the number of input/output points of the programmable controller according to your system.  
4. The signal is COM0 for FX<sub>3U</sub>-16MT/ES.  
5. The signal is COM4 for FX<sub>3U</sub>-16MT/ES.  
6. It is recommended that the connection be 2 m or shorter because an open-collector system is used.  
7. Select from the range of X000 to X007.



Be sure to read through Instruction Manual for the actual wiring and use. Use the equipment after you have a full knowledge of the equipment, safety information and instructions.

## MR-JE-A Standard Wiring Diagram Example: Position Control Operation

### Connecting to QD75D/LD75D (position servo, incremental)

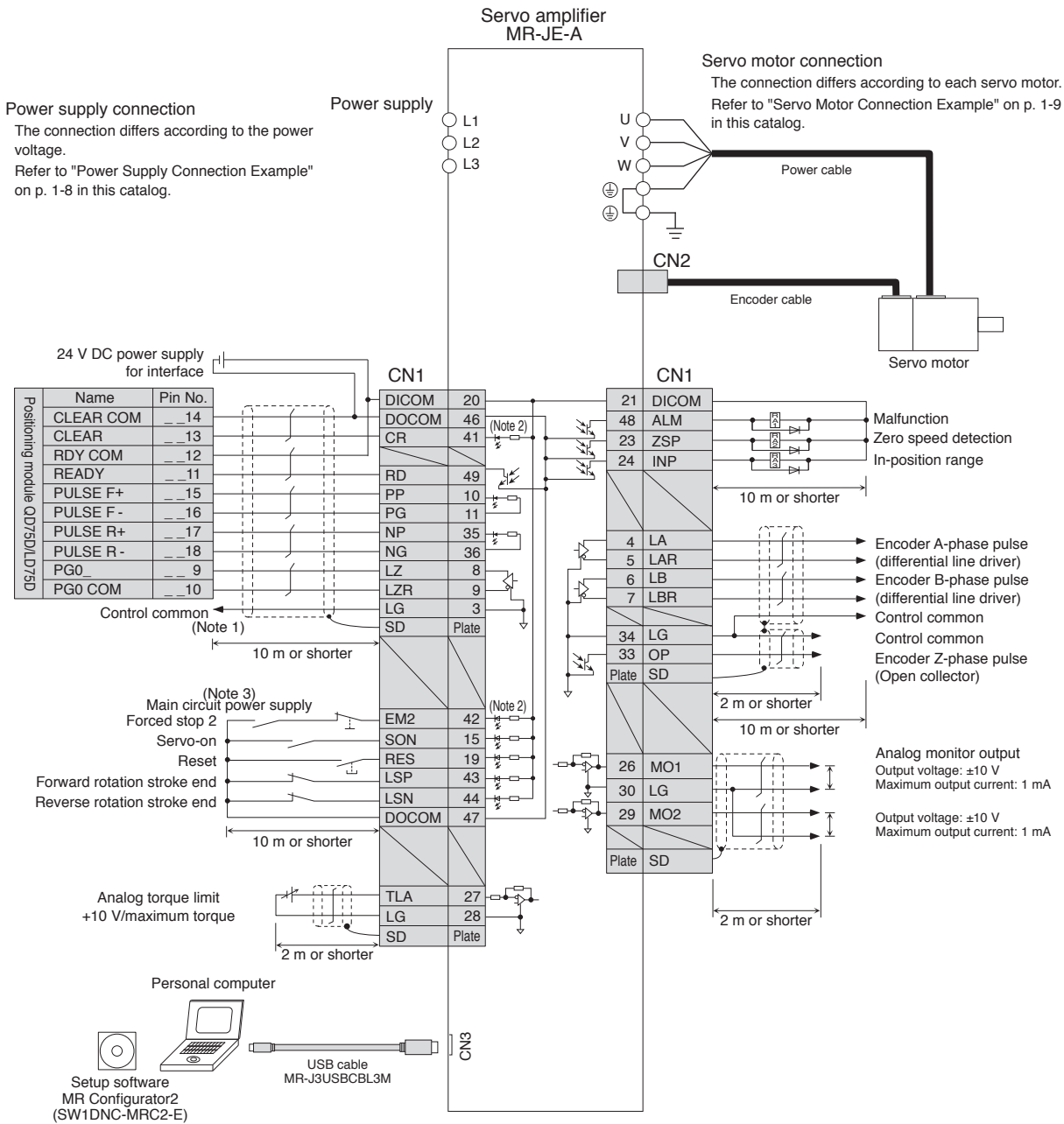

- Notes: 1. This connection is not necessary for QD75D/LD75D positioning module. Note that the connection between LG/LD and control common terminal is recommended for some positioning modules to improve noise immunity.  
 2. This is for sink wiring. Source wiring is also possible.  
 3. Create a circuit to turn off EM2 when the main circuit power is turned off to prevent an unexpected restart of the servo amplifier.



Be sure to read through Instruction Manual for the actual wiring and use. Use the equipment after you have a full knowledge of the equipment, safety information and instructions.



## MR-JE-A Standard Wiring Diagram Example: Speed Control Operation

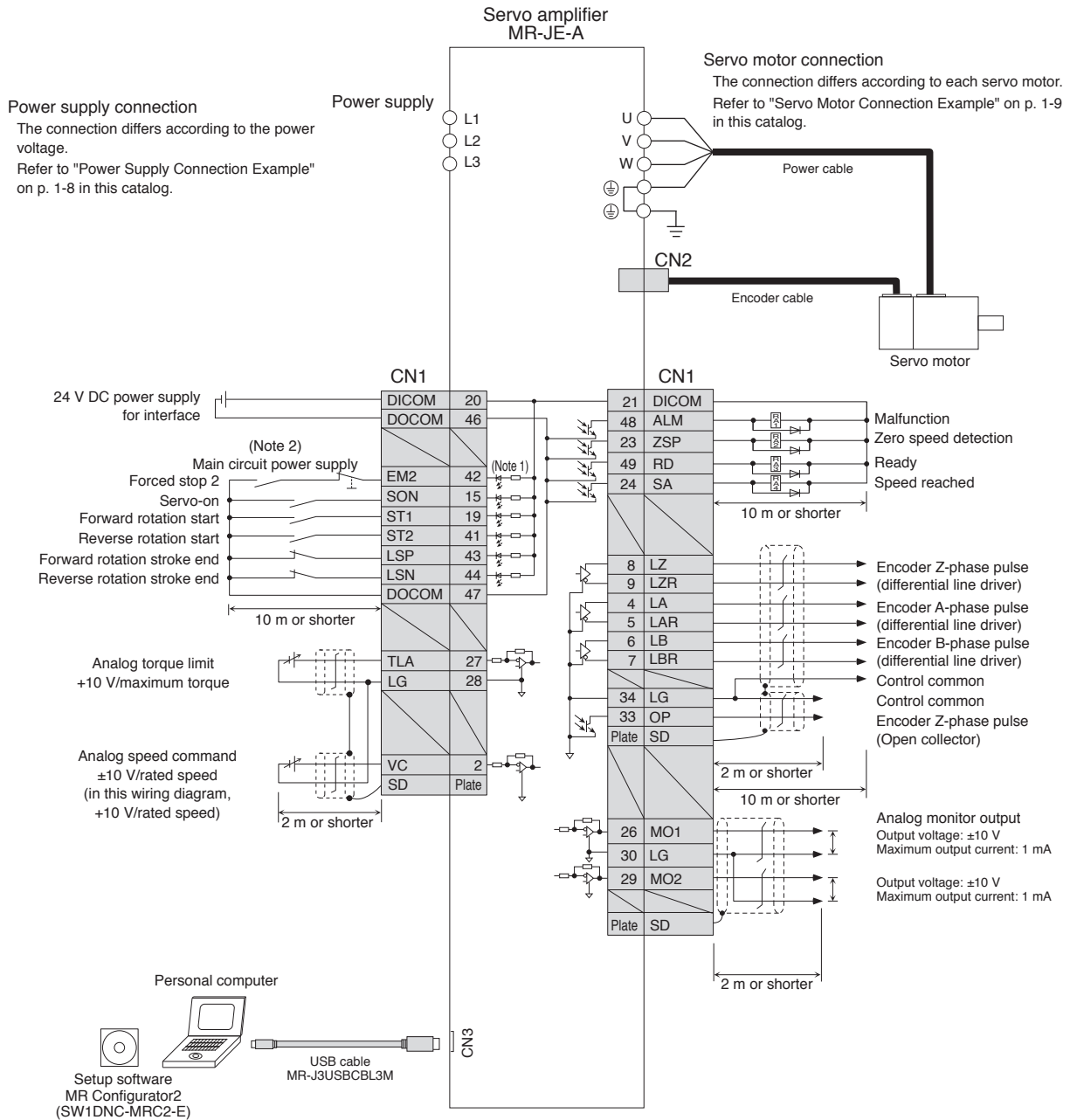

Notes: 1. This is for sink wiring. Source wiring is also possible.

2. Create a circuit to turn off EM2 when the main circuit power is turned off to prevent an unexpected restart of the servo amplifier.



Be sure to read through Instruction Manual for the actual wiring and use. Use the equipment after you have a full knowledge of the equipment, safety information and instructions.

## MR-JE-A Standard Wiring Diagram Example: Torque Control Operation

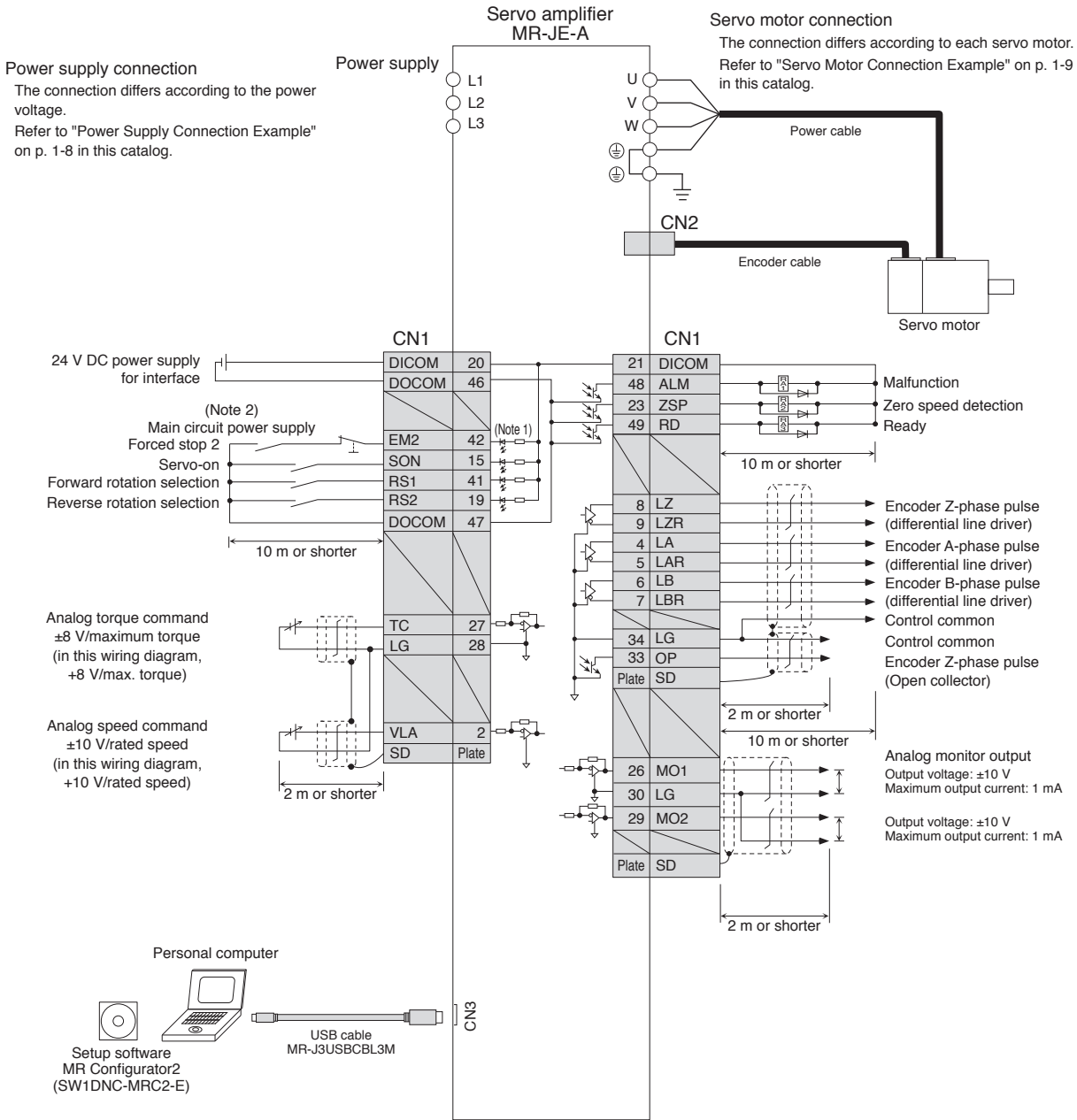

Notes: 1. This is for sink wiring. Source wiring is also possible.

2. Create a circuit to turn off EM2 when the main circuit power is turned off to prevent an unexpected restart of the servo amplifier.



Be sure to read through Instruction Manual for the actual wiring and use. Use the equipment after you have a full knowledge of the equipment, safety information and instructions.





## Power Supply Connection Example

### ● For 1-phase 200 V AC

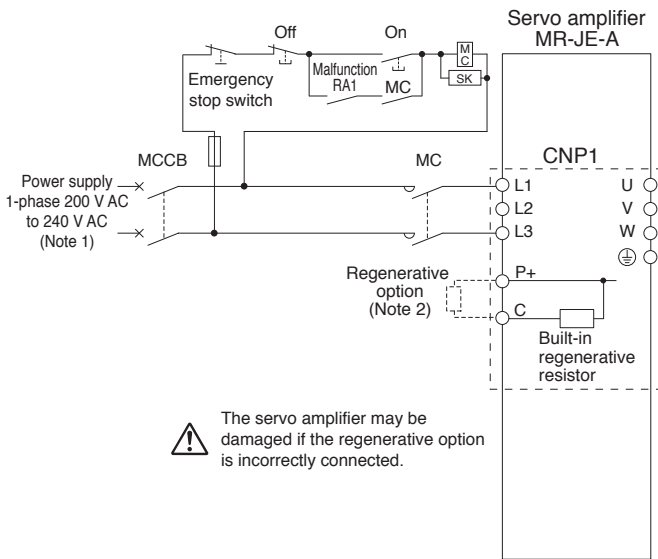

### ● For 3-phase 200 V AC, 1 kW or smaller

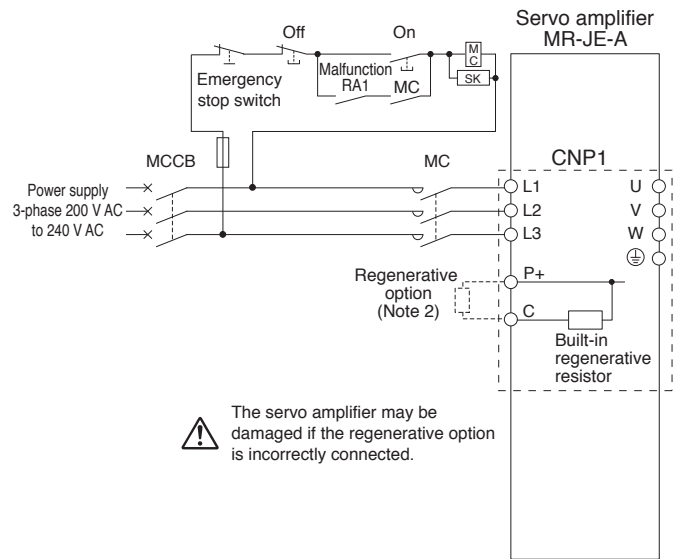

### ● For 3-phase 200 V AC, 2 kW and 3 kW

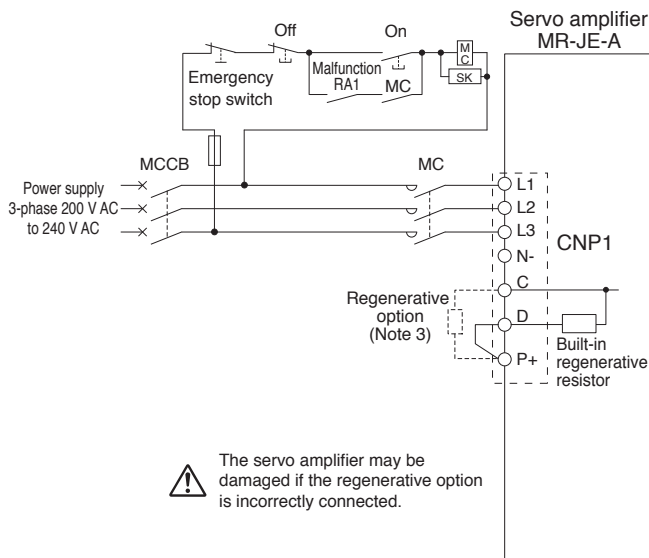

- Notes: 1. For 1-phase 200 V AC to 240 V AC, connect the power supply to L1 and L3 terminals. Do not connect anything to L2. The connections are different from MR-E Super series servo amplifiers. Be careful not to make a connection error when replacing MR-E Super with MR-JE.  
 2. Disconnect the wires for the built-in regenerative resistor (P+ and C) and remove the resistor when connecting the regenerative option externally.  
 3. Disconnect a short-circuit bar between P+ and D when connecting the regenerative option externally.



Be sure to read through Instruction Manual for the actual wiring and use. Use the equipment after you have a full knowledge of the equipment, safety information and instructions.

## Servo Motor Connection Example

### ● For HF-KN series

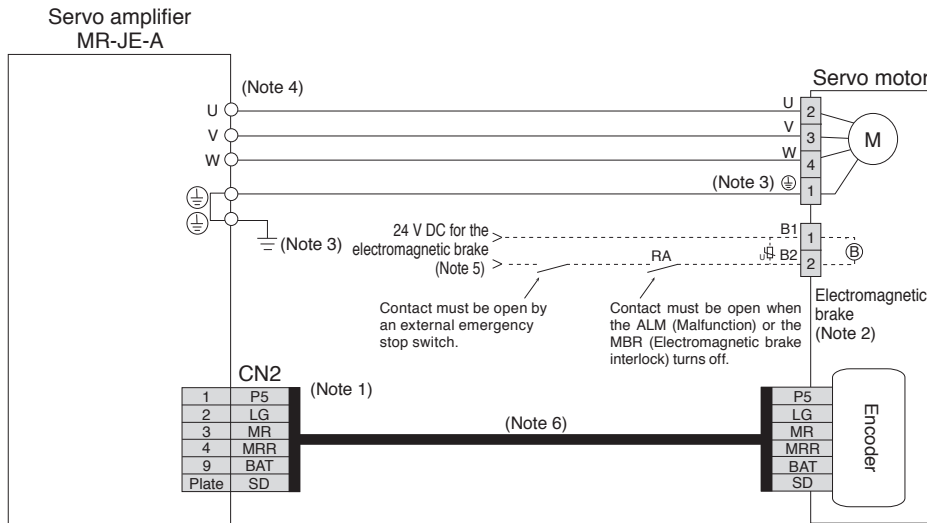

### ● For HF-SN series

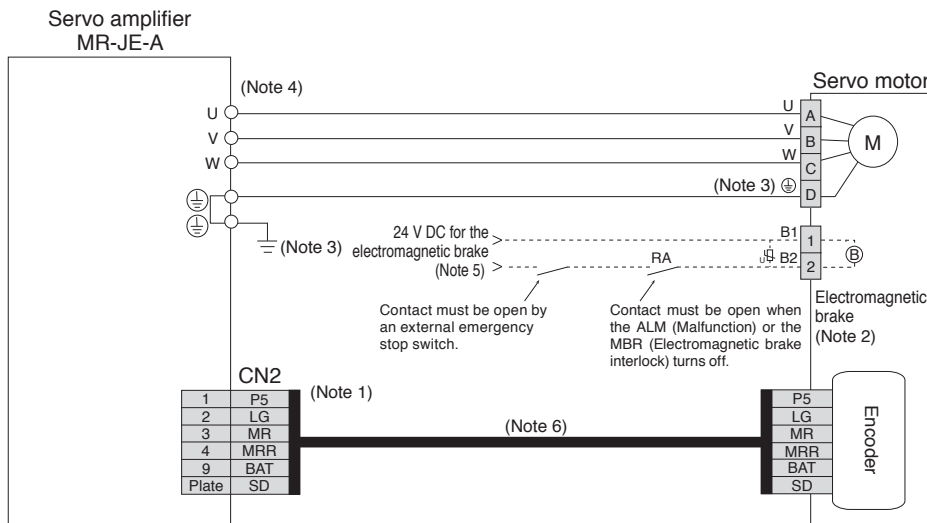

- Notes: 1. The signals shown is applicable when using a two-wire type encoder cable. Four-wire type is also compatible.  
 2. This is for the servo motor with electromagnetic brake. The electromagnetic brake terminals (B1, B2) do not have polarity.  
 3. For MR-JE-100A or smaller servo amplifier, connect the grounding terminal of the servo motor to the protective earth (PE) terminal (⊕) located on the lower front of the servo amplifier to the cabinet protective earth (PE).  
 For MR-JE-200A or larger servo amplifier, connect the grounding terminal of the servo motor to the protective earth (PE) terminal (⊕) located on the lower front of the servo amplifier, and connect the other protective earth (PE) terminal (⊕) to the cabinet protective earth (PE).  
 4. The connector varies depending on the servo amplifier capacities. Refer to "MR-JE-A Dimensions" in this catalog.  
 5. Do not use the 24 V DC interface power supply for the electromagnetic brake. Provide a dedicated power supply to the electromagnetic brake.  
 6. Encoder cable is available as an option. Refer to "HF-KN HF-SN Servo Motor Instruction Manual" when fabricating the cables.



Be sure to read through Instruction Manual for the actual wiring and use. Use the equipment after you have a full knowledge of the equipment, safety information and instructions.



## MR-JE-A Dimensions

- MR-JE-10A (Note 1)
- MR-JE-20A (Note 1)
- MR-JE-40A (Note 1)

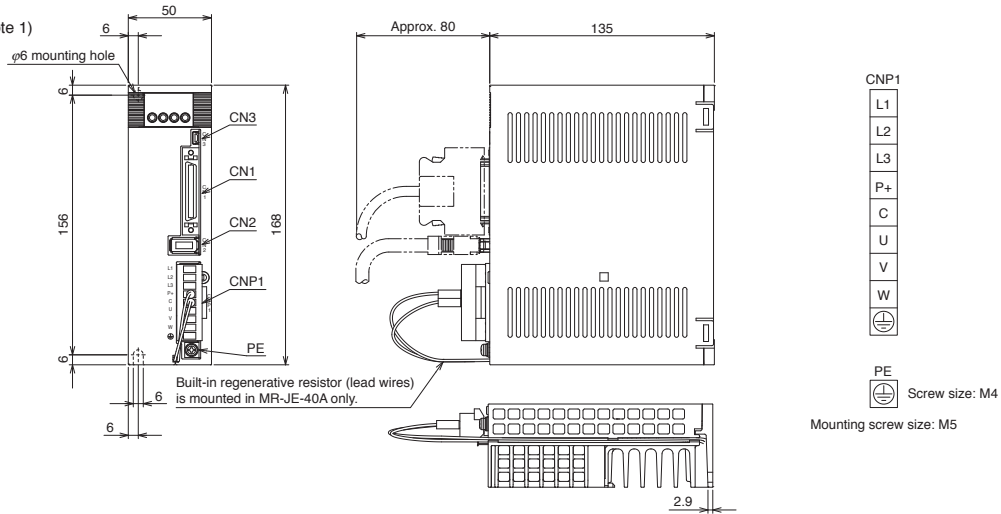

[Unit: mm]

- MR-JE-70A (Note 1)
- MR-JE-100A (Note 1)

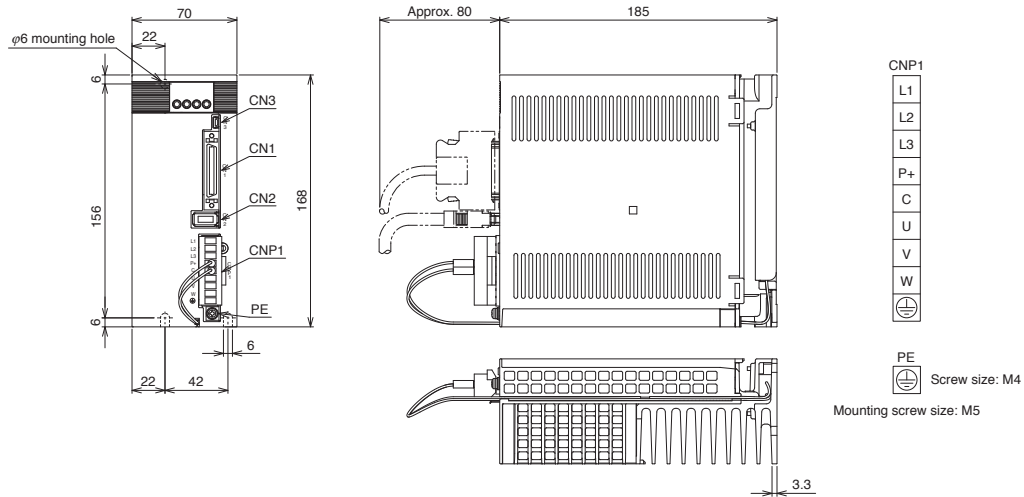

[Unit: mm]

- MR-JE-200A (Note 2)
- MR-JE-300A (Note 2)

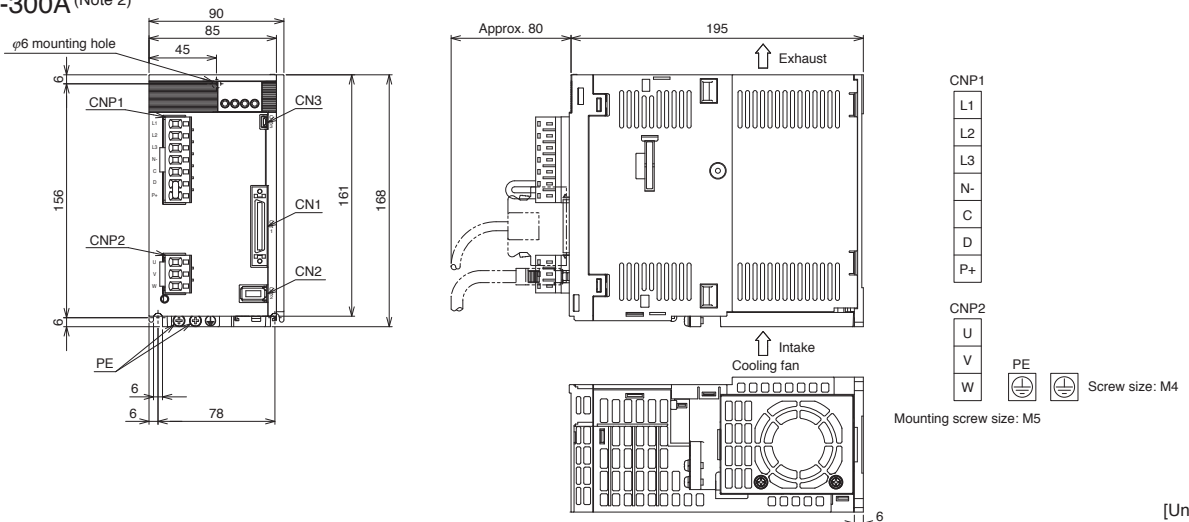

[Unit: mm]

Notes: 1. CNP1 connector (insertion type) is supplied with the servo amplifier.  
2. CNP1 and CNP2 connectors (insertion type) are supplied with the servo amplifier.

MEMO

---

# 2

Model Designation.....	2-1
Combinations of Servo Motor and Servo Amplifier.....	2-1
Specifications	
HF-KN series.....	2-2
HF-SN series.....	2-4
Dimensions	
HF-KN series.....	2-7
HF-SN series.....	2-10
Sizing Example.....	2-11

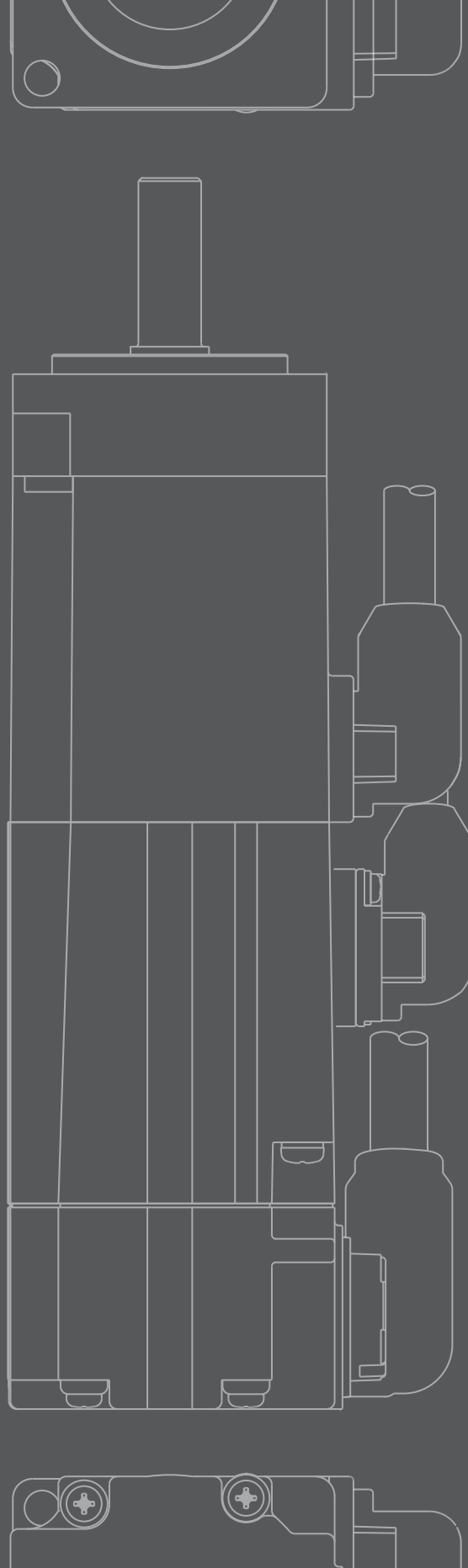

## Servo Motors

## Model Designation

HF - KN 1 3 B J □

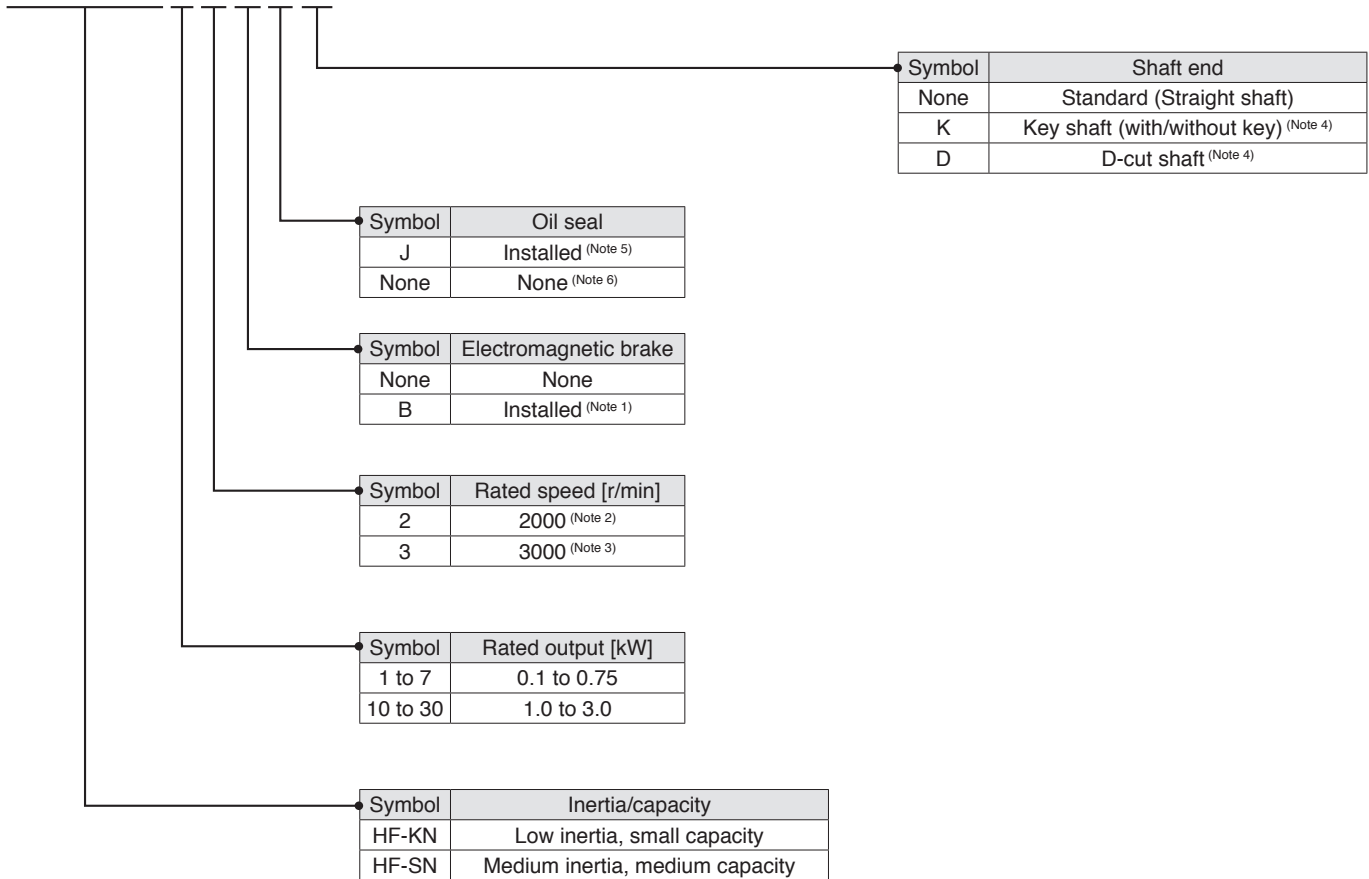

- Notes: 1. Refer to electromagnetic brake specifications of each servo motor series in this catalog for the available models and detailed specifications.  
 2. 2000 r/min is for HF-SN series only.  
 3. 3000 r/min is for HF-KN series only.  
 4. Refer to special shaft end specifications of each servo motor series in this catalog for the available models and detailed specifications.  
 5. An oil seal is attached as a standard for all servo motors.  
 6. Available in HF-KN13 to HF-KN43.

## Combinations of Servo Motor and Servo Amplifier

	Servo motor	Servo amplifier
HF-KN series	HF-KN13(B)J	MR-JE-10A
	HF-KN23(B)J	MR-JE-20A
	HF-KN43(B)J	MR-JE-40A
	HF-KN73(B)J	MR-JE-70A
HF-SN series	HF-SN52(B)J	MR-JE-70A
	HF-SN102(B)J	MR-JE-100A
	HF-SN152(B)J	MR-JE-200A
	HF-SN202(B)J	MR-JE-200A
	HF-SN302(B)J	MR-JE-300A



## HF-KN Series (Low Inertia, Small Capacity) Specifications

Servo motor model		HF-KN	13(B)J	23(B)J	43(B)J	73(B)J
Compatible servo amplifier model		Refer to "Combinations of Servo Motor and Servo Amplifier" on p. 2-1 in this catalog.				
Power supply capacity <sup>1</sup>		[kVA]	0.3	0.5	0.9	1.3
Continuous running duty	Rated output	[W]	100	200	400	750
	Rated torque <sup>(Note 3)</sup>	[N·m]	0.32	0.64	1.3	2.4
Maximum torque		[N·m]	0.95	1.9	3.8	7.2
Rated speed		[r/min]	3000			
Maximum speed		[r/min]	4500			
Permissible instantaneous speed		[r/min]	5175			
Power rate at continuous rated torque	Standard	[kW/s]	11.5	16.9	38.6	39.9
	With electromagnetic brake	[kW/s]	11.3	13.1	32.5	35.0
Rated current		[A]	0.8	1.3	2.7	4.8
Maximum current		[A]	2.4	3.9	8.1	14
Regenerative braking frequency <sup>2,3</sup>		[times/min]	(Note 4)	(Note 4)	249	140
Moment of inertia J	Standard	[× 10 <sup>-4</sup> kg·m <sup>2</sup> ]	0.088	0.24	0.42	1.43
	With electromagnetic brake	[× 10 <sup>-4</sup> kg·m <sup>2</sup> ]	0.090	0.31	0.50	1.63
Recommended load to motor inertia ratio <sup>(Note 1)</sup>		15 times or less				
Speed/position detector		Incremental 17-bit encoder (resolution: 131072 pulses/rev)				
Oil seal		Installed. Without oil seal is also available.				Installed
Insulation class		130 (B)				
Structure		Totally enclosed, natural cooling (IP rating: IP65) <sup>(Note 2)</sup>				
Environment <sup>4</sup>	Ambient temperature	0 °C to 40 °C (non-freezing), storage: -15 °C to 70 °C (non-freezing)				
	Ambient humidity	80 %RH maximum (non-condensing), storage: 90 %RH maximum (non-condensing)				
	Ambience	Indoors (no direct sunlight); no corrosive gas, inflammable gas, oil mist or dust				
	Altitude	1000 m or less above sea level				
Vibration resistance <sup>5</sup>		X: 49 m/s <sup>2</sup> Y: 49 m/s <sup>2</sup>				
Vibration rank		V10 <sup>7</sup>				
Compliance to standards		Refer to "Conformity with global standards and regulations" on p. 13 in this catalog.				
Permissible load for the shaft <sup>6</sup>	L	[mm]	25	30	30	40
	Radial	[N]	88	245	245	392
	Thrust	[N]	59	98	98	147
Mass	Standard	[kg]	0.6	1.2	1.6	3.1
	With electromagnetic brake	[kg]	0.8	1.6	2.0	4.1

- Notes: 1. Contact your local sales office if the load to motor inertia ratio exceeds the value in the table.  
 2. The shaft-through portion is excluded. Refer to the asterisk 8 of "Annotations for Servo Motor Specifications" on p. 2-6 in this catalog for the shaft-through portion.  
 3. When unbalanced torque is generated, such as in a vertical lift machine, it is recommended that the unbalanced torque of the machine be kept under 70% of the servo motor rated torque.  
 4. When the servo motor decelerates to a stop from the rated speed, the regenerative frequency will not be limited if the effective torque is within the rated torque range. Note that the recommended load to motor inertia ratio is 15 times or less.

Refer to "Annotations for Servo Motor Specifications" on p. 2-6 in this catalog for the asterisks 1 to 7.

## HF-KN Series Electromagnetic Brake Specifications (Note 1)

Servo motor model	HF-KN	13BJ	23BJ	43BJ	73BJ
Type	Spring actuated type safety brake				
Rated voltage	24 V DC $-10\%$				
Power consumption [W] at 20 °C		6.3	7.9	7.9	10
Electromagnetic brake static friction torque [N·m]		0.32	1.3	1.3	2.4
Permissible braking work	Per braking [J]	5.6	22	22	64
	Per hour [J]	56	220	220	640
Electromagnetic brake life (Note 2)	Number of brakings [Times]	20000	20000	20000	20000
	Work per braking [J]	5.6	22	22	64

Notes: 1. The electromagnetic brake is for holding. It should not be used for deceleration applications.  
 2. Brake gap is not adjustable. Electromagnetic brake life is defined as the time period until the readjustment is needed.

## HF-KN Series Torque Characteristics (Note 3, 4)

### HF-KN13(B)J (Note 1, 2)

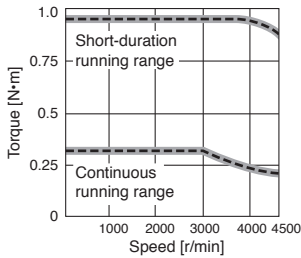

### HF-KN23(B)J (Note 1, 2)

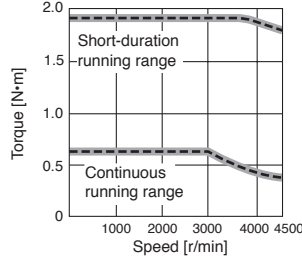

### HF-KN43(B)J (Note 1, 2)

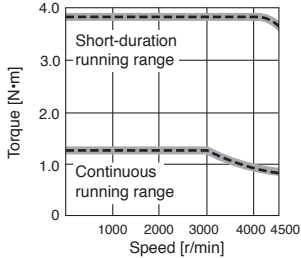

### HF-KN73(B)J (Note 1, 2)

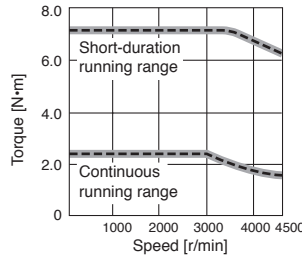

Notes: 1. ——— : For 3-phase 200 V AC.  
 2. - - - - : For 1-phase 230 V AC.  
 3. Torque drops when the power supply voltage is below the specified value.  
 4. The value is for reference.

## HF-KN Series Special Shaft End Specifications

Motors with the following specifications are also available.

D-cut shaft (Note 1): 100 W

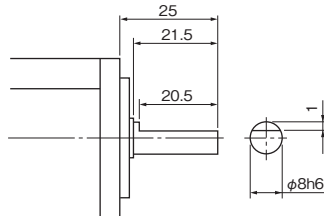

[Unit: mm]

Key shaft (with key) (Note 1, 2): 200 W, 400 W, and 750 W

Model	Variable dimensions									
	T	S	R	Q	W	QK	QL	U	Y	
HF-KN	23(B)JK, 43(B)JK	5	14h6	30	27	5	20	3	3	M4 screw Depth: 15
	73(B)JK	6	19h6	40	37	6	25	5	3.5	M5 screw Depth: 20

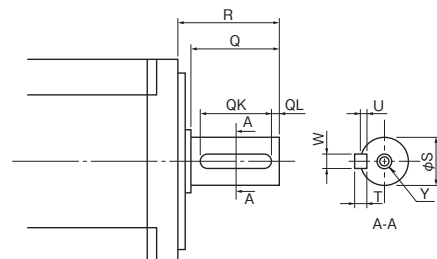

[Unit: mm]

Notes: 1. The servo motors with special shaft end are not suitable for frequent start/stop applications.  
 2. 2 round end key is attached.





## HF-SN Series (Medium Inertia, Medium Capacity) Specifications

Servo motor model		HF-SN	52(B)J	102(B)J	152(B)J	202(B)J	302(B)J	
Compatible servo amplifier model		Refer to "Combinations of Servo Motor and Servo Amplifier" on p. 2-1 in this catalog.						
Power supply capacity <sup>1</sup>		[kVA]	1.0	1.7	2.5	3.5	4.8	
Continuous running duty	Rated output	[kW]	0.5	1.0	1.5	2.0	3.0	
	Rated torque <sup>(Note 3)</sup>	[N·m]	2.39	4.77	7.16	9.55	14.3	
Maximum torque		[N·m]	7.16	14.3	21.5	28.6	42.9	
Rated speed		[r/min]	2000					
Maximum speed		[r/min]	3000					2500
Permissible instantaneous speed		[r/min]	3450					2875
Power rate at continuous rated torque	Standard	[kW/s]	9.34	19.2	28.8	23.8	35.1	
	With electromagnetic brake	[kW/s]	6.87	16.3	25.6	19.0	30.1	
Rated current		[A]	2.9	6.0	8.6	9.0	11	
Maximum current		[A]	8.7	18	26	27	33	
Regenerative braking frequency <sup>2,3</sup>		[times/min]	120	62	152	71	28	
Moment of inertia J	Standard	[× 10 <sup>-4</sup> kg·m <sup>2</sup> ]	6.1	11.9	17.8	38.3	58.5	
	With electromagnetic brake	[× 10 <sup>-4</sup> kg·m <sup>2</sup> ]	8.3	14.0	20.0	47.9	68.1	
Recommended load to motor inertia ratio <sup>(Note 1)</sup>		15 times or less						
Speed/position detector		Incremental 17-bit encoder (resolution: 131072 pulses/rev)						
Oil seal		Installed						
Insulation class		155 (F)						
Structure		Totally enclosed, natural cooling (IP rating: IP67) <sup>(Note 2)</sup>						
Environment <sup>4</sup>	Ambient temperature	0 °C to 40 °C (non-freezing), storage: -15 °C to 70 °C (non-freezing)						
	Ambient humidity	80 %RH maximum (non-condensing), storage: 90 %RH maximum (non-condensing)						
	Ambience	Indoors (no direct sunlight); no corrosive gas, inflammable gas, oil mist or dust						
	Altitude	1000 m or less above sea level						
Vibration resistance <sup>5</sup>		X: 24.5 m/s <sup>2</sup> Y: 24.5 m/s <sup>2</sup>				X: 24.5 m/s <sup>2</sup> Y: 49 m/s <sup>2</sup>		
Vibration rank		V10 <sup>7</sup>						
Compliance to standards		Refer to "Conformity with global standards and regulations" on p. 13 in this catalog.						
Permissible load for the shaft <sup>6</sup>	L	[mm]	55	55	55	79	79	
	Radial	[N]	980	980	980	2058	2058	
	Thrust	[N]	490	490	490	980	980	
Mass	Standard	[kg]	4.8	6.5	8.3	12	15	
	With electromagnetic brake	[kg]	6.7	8.5	10.3	18	21	

Notes: 1. Contact your local sales office if the load to motor inertia ratio exceeds the value in the table.

2. The shaft-through portion is excluded. Refer to the asterisk 8 of "Annotations for Servo Motor Specifications" on p. 2-6 in this catalog for the shaft-through portion.

3. When unbalanced torque is generated, such as in a vertical lift machine, it is recommended that the unbalanced torque of the machine be kept under 70% of the servo motor rated torque.

Refer to "Annotations for Servo Motor Specifications" on p. 2-6 in this catalog for the asterisks 1 to 7.

## HF-SN Series Electromagnetic Brake Specifications (Note 1)

Servo motor model	HF-SN	52BJ	102BJ	152BJ	202BJ	302BJ
Type	Spring actuated type safety brake					
Rated voltage	24 V DC $^{+0}_{-10}\%$					
Power consumption [W] at 20 °C		20	20	20	34	34
Electromagnetic brake static friction torque [N·m]		8.5	8.5	8.5	44	44
Permissible braking work	Per braking [J]	400	400	400	4500	4500
	Per hour [J]	4000	4000	4000	45000	45000
Electromagnetic brake life (Note 2)	Number of brakings [Times]	20000	20000	20000	20000	20000
	Work per braking [J]	200	200	200	1000	1000

Notes: 1. The electromagnetic brake is for holding. It should not be used for deceleration applications.  
 2. Brake gap is not adjustable. Electromagnetic brake life is defined as the time period until the readjustment is needed.

## HF-SN Series Torque Characteristics (Note 3, 4)

HF-SN52(B)J (Note 1, 2)

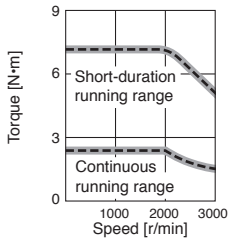

HF-SN102(B)J (Note 1)

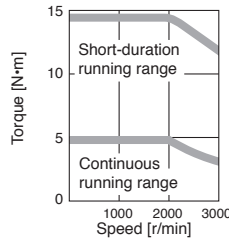

HF-SN152(B)J (Note 1)

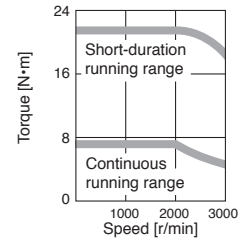

HF-SN202(B)J (Note 1)

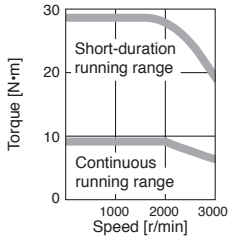

HF-SN302(B)J (Note 1)

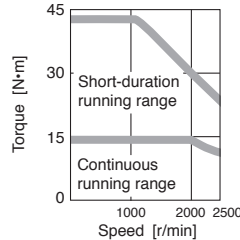

Notes: 1. — : For 3-phase 200 V AC.  
 2. - - - : For 1-phase 230 V AC.  
 3. Torque drops when the power supply voltage is below the specified value.  
 4. The value is for reference.

## HF-SN Series Special Shaft End Specifications

Motors with the following specifications are also available.

Key shaft (without key) (Note 1, 2)

Model	Variable dimensions								
	S	R	Q	W	QK	QL	U	r	Y
HF-SN 52(B)JK, 102(B)JK, 152(B)JK	24h6	55	50	8 <sup>0</sup> <sub>-0.036</sub>	36	5	4 <sup>+0.2</sup> <sub>0</sub>	4	M8 screw Depth: 20
HF-SN 202(B)JK, 302(B)JK	35 <sup>+0.010</sup> <sub>0</sub>	79	75	10 <sup>0</sup> <sub>-0.036</sub>	55	5	5 <sup>+0.2</sup> <sub>0</sub>	5	

Notes: 1. The servo motors with special shaft end are not suitable for frequent start/stop applications.  
 2. A key is not supplied with the servo motor. The key shall be installed by the user.

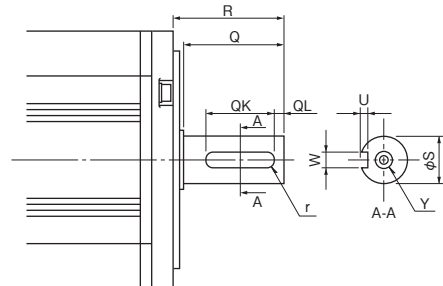

[Unit: mm]



## Annotations for Servo Motor Specifications

- \*1. The power supply capacity varies depending on the power supply impedance.
- \*2. The regenerative braking frequency shows the permissible frequency when the servo motor, without a load and a regenerative option, decelerates from the rated speed to a stop. When a load is connected; however, the value will be the table value/(m+1), where m = Moment of inertia of load/Moment of inertia of servo motor. When the operating speed exceeds the rated speed, the regenerative braking frequency is inversely proportional to the square of (operating speed/rated speed). Take measures to keep the regenerative power [W] during operation below the tolerable regenerative power [W]. Use caution, especially when the operating speed changes frequently or when the regeneration is constant (as with vertical feeds). Select the most suitable regenerative option for your system with our capacity selection software. Refer to "Regenerative Option" in this catalog for the tolerable regenerative power [W] when regenerative option is used.
- \*3. For 400 W or smaller servo amplifier, the regenerative braking frequency may change affected by the power supply voltage due to the large ratio of the energy charged into the electrolytic capacitor in the servo amplifier.
- \*4. In the environment where the servo motor is exposed to oil mist, oil and/or water, a standard specification servo motor may not be usable. Contact your local sales office for more details.
- \*5. The vibration direction is shown in the diagram below. The numerical value indicates the maximum value of the component (commonly the bracket in the opposite direction of the servo motor shaft). Fretting more likely occurs on the bearing when the servo motor stops. Thus, maintain vibration level at approximately one-half of the allowable value.

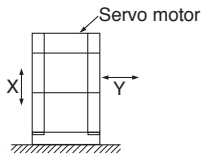

- \*6. Refer to the diagram below for the permissible load for the shaft. Do not apply a load exceeding the value specified in the table on the shaft. The values in the table are applicable when each load is applied singly.

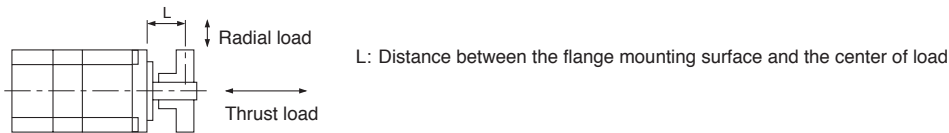

- \*7. V10 indicates that the amplitude of the servo motor itself is 10  $\mu\text{m}$  or less. The following shows mounting posture and measuring position of the servo motor during the measurement:

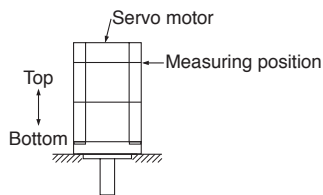

- \*8. Refer to the diagram below for shaft-through portion.

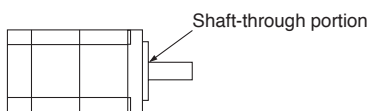

## HF-KN Series Dimensions (Note 1, 5)

### ●HF-KN13(B)J

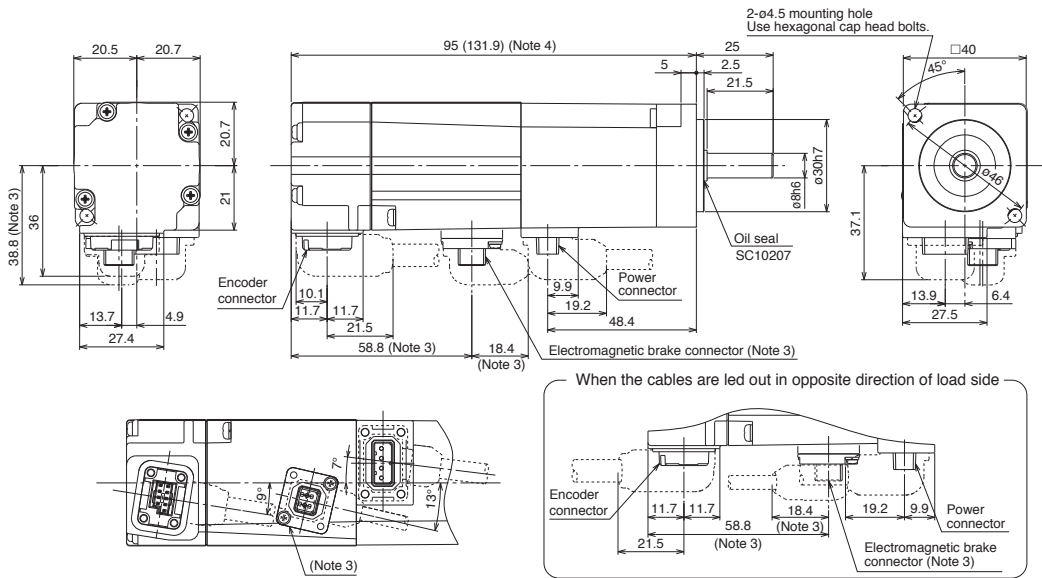

Power connector



Pin No.	Signal name
1	⊕ (PE)
2	U
3	V
4	W

Electromagnetic brake connector (Note 2)



Pin No.	Signal name
1	B1
2	B2

[Unit: mm]

### ●HF-KN13(B)

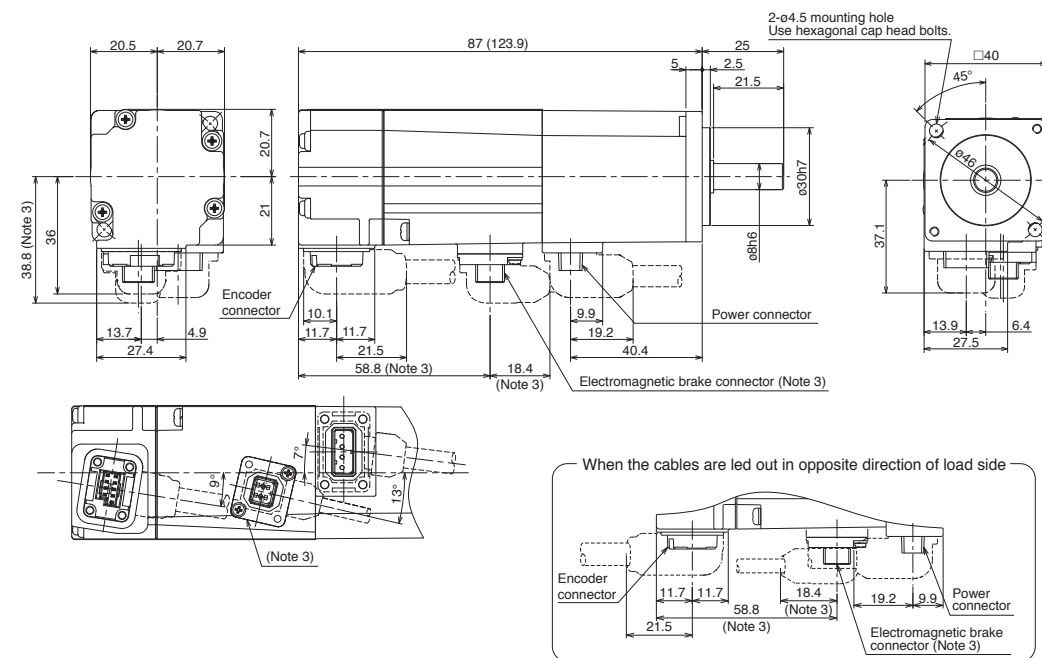

Power connector



Pin No.	Signal name
1	⊕ (PE)
2	U
3	V
4	W

Electromagnetic brake connector (Note 2)



Pin No.	Signal name
1	B1
2	B2

[Unit: mm]

- Notes: 1. For dimensions without tolerance, general tolerance applies.  
 2. The electromagnetic brake terminals (B1, B2) do not have polarity.  
 3. Only for the models with electromagnetic brake.  
 4. Dimensions in brackets are for the models with electromagnetic brake.  
 5. Use a friction coupling to fasten a load.



### HF-KN Series Dimensions (Note 1, 5)

#### ● HF-KN23(B)J, HF-KN43(B)J

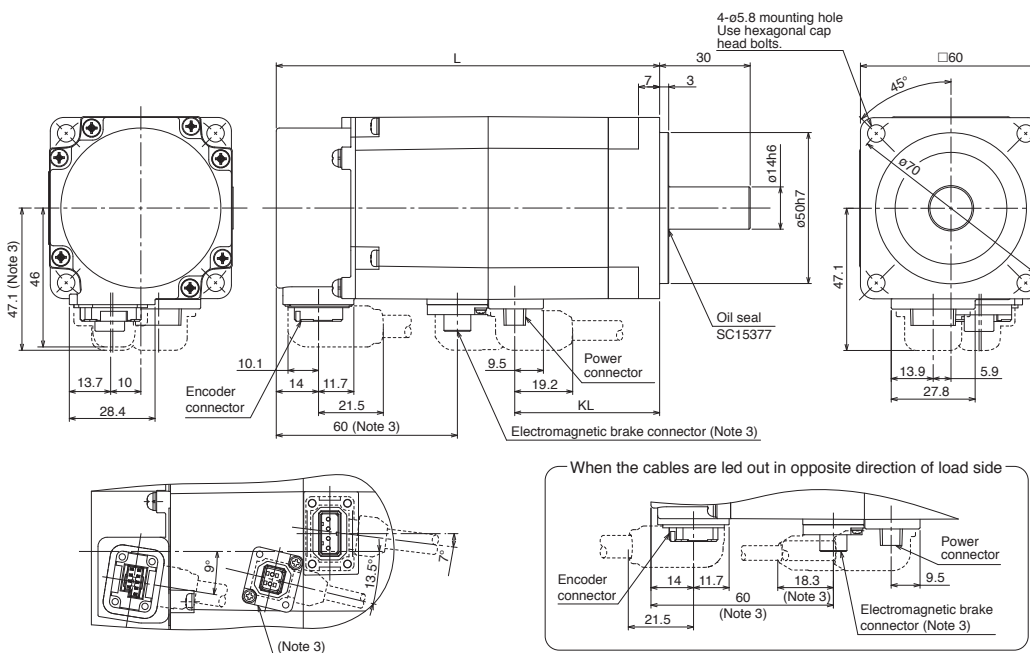

Power connector



Pin No.	Signal name
1	⊕ (PE)
2	U
3	V
4	W

Electromagnetic brake connector (Note 2)



Pin No.	Signal name
1	B1
2	B2

Model	Variable dimensions (Note 4)	
	L	KL
HF-KN23(B)J	98.4 (127)	48
HF-KN43(B)J	120.4 (149)	70

[Unit: mm]

#### ● HF-KN23(B), HF-KN43(B)

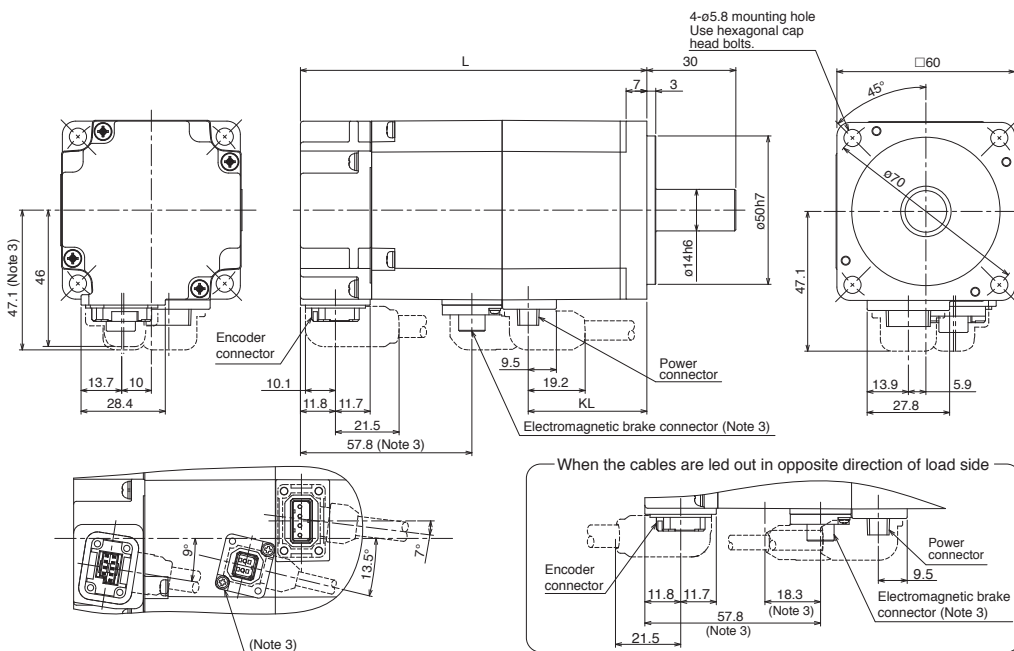

Power connector



Pin No.	Signal name
1	⊕ (PE)
2	U
3	V
4	W

Electromagnetic brake connector (Note 2)



Pin No.	Signal name
1	B1
2	B2

Model	Variable dimensions (Note 4)	
	L	KL
HF-KN23(B)	88.2 (116.8)	40
HF-KN43(B)	110.2 (138.8)	62

[Unit: mm]

- Notes: 1. For dimensions without tolerance, general tolerance applies.  
 2. The electromagnetic brake terminals (B1, B2) do not have polarity.  
 3. Only for the models with electromagnetic brake.  
 4. Dimensions in brackets are for the models with electromagnetic brake.  
 5. Use a friction coupling to fasten a load.

Servo Amplifiers

Servo Motors

Options/Peripheral Equipment

LVS/Wires

Product List

Cautions

## HF-KN Series Dimensions (Note 1, 5)

### ● HF-KN73(B)J

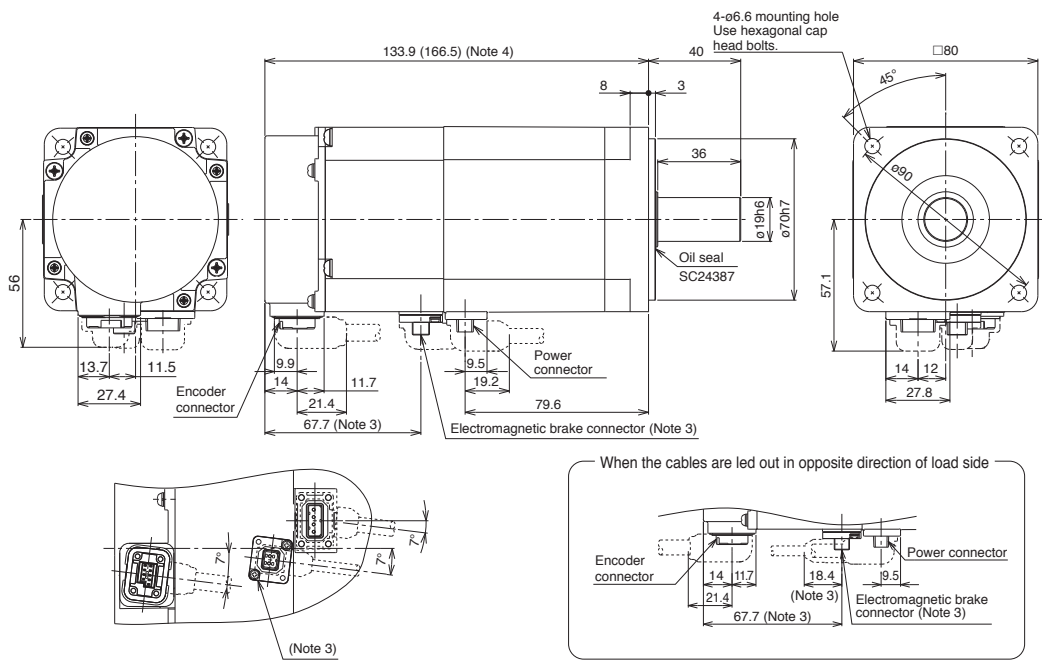

Power connector



Pin No.	Signal name
1	(PE)
2	U
3	V
4	W

Electromagnetic brake connector (Note 2)



Pin No.	Signal name
1	B1
2	B2

When the cables are led out in opposite direction of load side

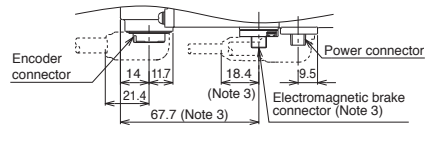

[Unit: mm]

- Notes: 1. For dimensions without tolerance, general tolerance applies.  
 2. The electromagnetic brake terminals (B1, B2) do not have polarity.  
 3. Only for the models with electromagnetic brake.  
 4. Dimensions in brackets are for the models with electromagnetic brake.  
 5. Use a friction coupling to fasten a load.



### HF-SN Series Dimensions (Note 1, 5)

#### ● HF-SN52(B)J, HF-SN102(B)J, HF-SN152(B)J

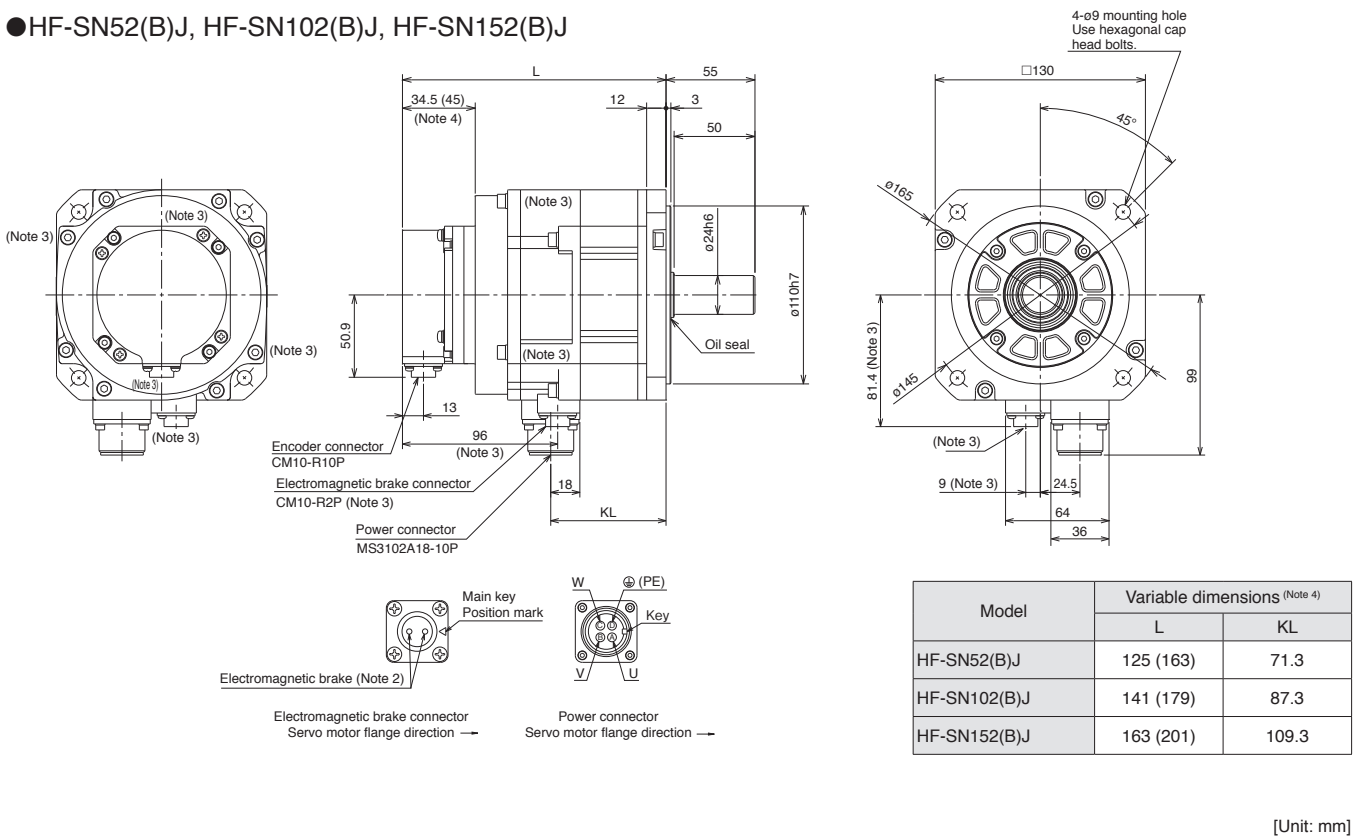

#### ● HF-SN202(B)J, HF-SN302(B)J

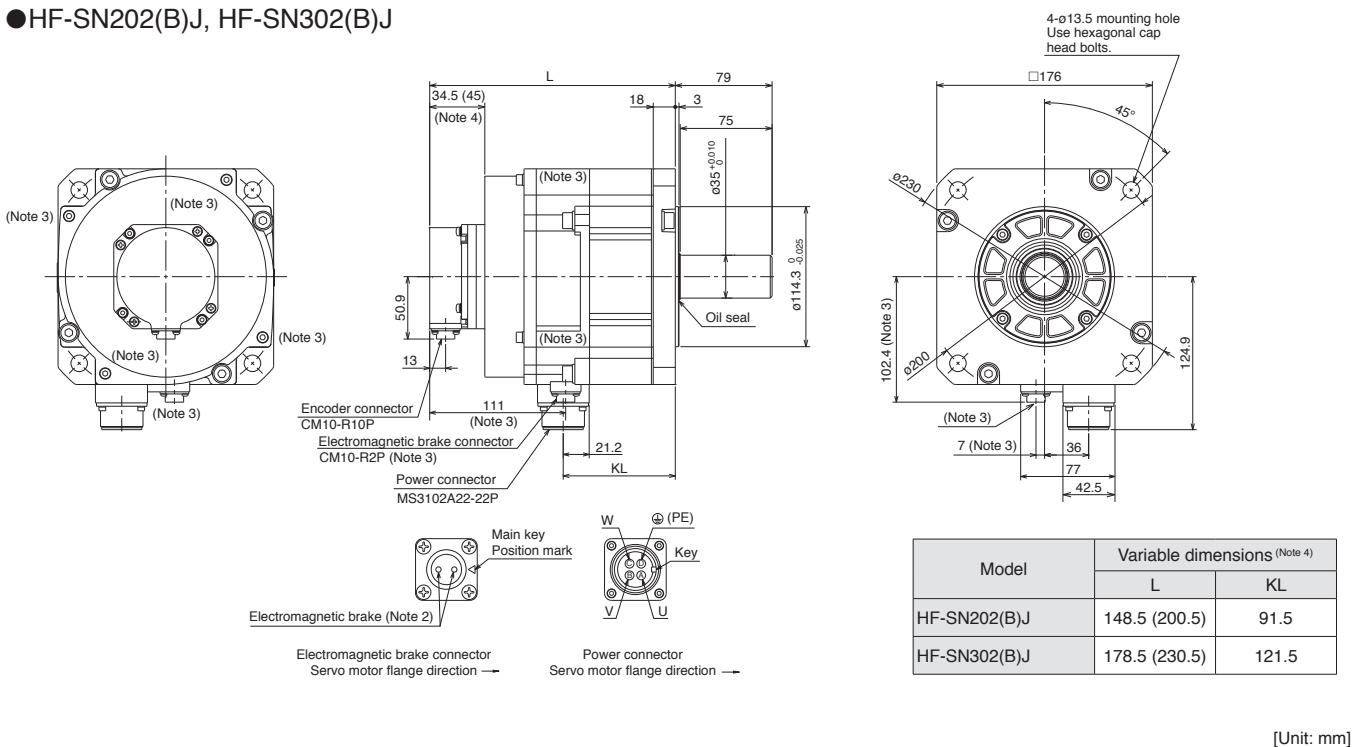

- Notes: 1. For dimensions without tolerance, general tolerance applies.  
 2. The electromagnetic brake terminals do not have polarity.  
 3. Only for the models with electromagnetic brake.  
 4. Dimensions in brackets are for the models with electromagnetic brake.  
 5. Use a friction coupling to fasten a load.

Servo Amplifiers

Servo Motors

Options/Peripheral Equipment

LVS/Wires

Product List

Cautions

## Servo Motor Sizing Example

### 1. Selection criteria

#### (1) Configurations

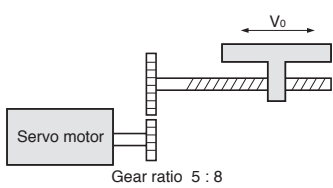

Feed speed of moving part  
Feed length per cycle  
Positioning time  
Number of feed times  
(Operating cycle)  
Reduction ratio  
Moving part mass  
Drive system efficiency  
Friction coefficient  
Ball screw lead

$V_0 = 30000 \text{ mm/min}$   
 $\ell = 400 \text{ mm}$   
 $t_0 = \text{within } 1 \text{ s}$   
40 times/min  
 $t_r = 1.5 \text{ s}$   
 $1/n = 5/8$   
 $W = 60 \text{ kg}$   
 $\eta = 0.8$   
 $\mu = 0.2$   
 $P_B = 16 \text{ mm}$

$D_B = \text{ball screw diameter } 20 \text{ mm}$   
 $L_B = \text{ball screw length } 500 \text{ mm}$   
 $D_{G1} = \text{gear diameter (servo motor shaft) } 25 \text{ mm}$   
 $D_{G2} = \text{gear diameter (load shaft) } 40 \text{ mm}$   
 $L_G = \text{gear tooth thickness } 10 \text{ mm}$

#### (2) Servo motor speed

$$N_0 = \frac{V_0}{P_B} \times \frac{1}{1/n} = \frac{30000}{16} \times \frac{8}{5} = 3000 \text{ r/min}$$

#### (3) Acceleration/deceleration time constant

$$t_{psa} = t_{psd} = t_0 - \frac{\ell}{V_0/60} - t_s = 0.05 \text{ s}$$

$t_s$ : settling time. Here assumed 0.15 s.

#### (4) Operating pattern

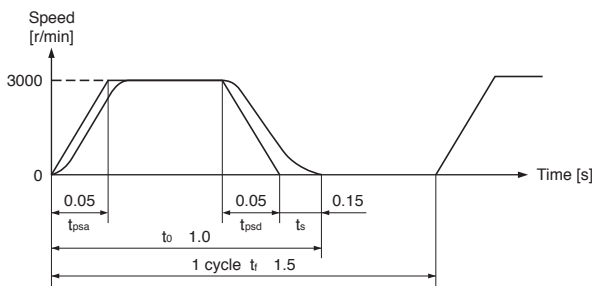

#### (3) Select a servo motor

##### Selection criteria

Load torque < Rated torque of servo motor

Moment of inertia of all loads <  $J_R$  × Moment of inertia of servo motor

$J_R$ : Recommended load to motor inertia ratio

Select the following servo motor to meet the criteria above.

HF-KN23J (rated torque: 0.64 N·m, max. torque: 1.9 N·m, moment of inertia:  $0.24 \times 10^{-4} \text{ kg}\cdot\text{m}^2$ )

#### (4) Acceleration/deceleration torque

Torque required during acceleration

$$T_{Ma} = \frac{(J_L / \eta + J_M) \times N_0}{9.55 \times 10^4 \times t_{psa}} + T_L = 1.85 \text{ N}\cdot\text{m}$$

$J_M$ : moment of inertia of servo motor

Torque required during deceleration

$$T_{Md} = -\frac{(J_L \times \eta + J_M) \times N_0}{9.55 \times 10^4 \times t_{psd}} + T_L = -0.86 \text{ N}\cdot\text{m}$$

Torque required during acceleration/deceleration must be equal to or lower than the max. torque of the servo motor.

## 2. Selecting servo motor

#### (1) Load torque (converted into the servo motor shaft)

Travel distance per servo motor revolution

$$\Delta S = P_B \times \frac{1}{n} = 10 \text{ mm}$$

$$T_L = \frac{\mu \times W \times g \times \Delta S}{2 \times 10^3 \pi \eta} = 0.23 \text{ N}\cdot\text{m}$$

#### (2) Moment of inertia of load (converted into the servo motor shaft)

Moving part

$$J_{L1} = W \times \left( \frac{\Delta S \times 10^{-3}}{2\pi} \right)^2 = 1.52 \times 10^{-4} \text{ kg}\cdot\text{m}^2$$

Ball screw

$$J_{L2} = \frac{\pi \times \rho \times L_B}{32} \times D_B^4 \times \left( \frac{1}{n} \right)^2 = 0.24 \times 10^{-4} \text{ kg}\cdot\text{m}^2$$

$\rho = 7.8 \times 10^3 \text{ kg/m}^3$  (iron)

Gear (servo motor shaft)

$$J_{L3} = \frac{\pi \times \rho \times L_G}{32} \times D_{G1}^4 = 0.03 \times 10^{-4} \text{ kg}\cdot\text{m}^2$$

Gear (load shaft)

$$J_{L4} = \frac{\pi \times \rho \times L_G}{32} \times D_{G2}^4 \times \left( \frac{1}{n} \right)^2 = 0.08 \times 10^{-4} \text{ kg}\cdot\text{m}^2$$

Moment of inertia of all loads (converted into the servo motor shaft)

$$J_L = J_{L1} + J_{L2} + J_{L3} + J_{L4} = 1.87 \times 10^{-4} \text{ kg}\cdot\text{m}^2$$

#### (5) Continuous effective load torque

$$T_{rms} = \sqrt{\frac{T_{Ma}^2 \times t_{psa} + T_L^2 \times t_c + T_{Md}^2 \times t_{psd}}{t_i}} = 0.41 \text{ N}\cdot\text{m}$$

$t_c = t_0 - t_s - t_{psa} - t_{psd}$

Continuous effective load torque must be equal to or lower than the rated torque of the servo motor.

#### (6) Torque pattern

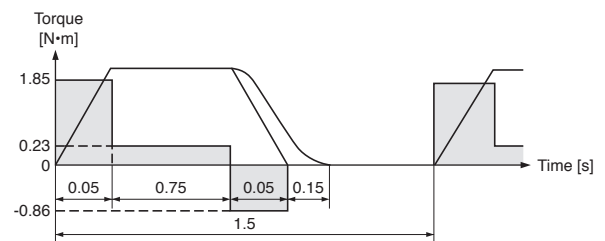

#### (7) Result

Select the following:

Servo motor: HF-KN23J

Servo amplifier: MR-JE-20A

[Free capacity selection software]

Capacity selection software (MRZJW3-MOTSZ111E) does all the calculations for you. The capacity selection software is available for free download. Contact your local sales office for more details.

\* MRZJW3-MOTSZ111E software version C6 or later is compatible.



# 3

Basic Cable Configurations for Servo Motors.....	3-1
Configuration Example for Servo Motors.....	3-3
Details of Optional Cables and Connectors for Servo Motors ....	3-9
Products on the Market for Servo Motors.....	3-11
Configuration Example for Servo Amplifiers .....	3-15
Details of Optional Cables and Connectors for Servo Amplifiers ..	3-17
Regenerative Option.....	3-18
Junction Terminal Block.....	3-20
Radio Noise Filter .....	3-20
Line Noise Filter.....	3-20
Data Line Filter .....	3-20
Surge Killer .....	3-20
EMC Filter.....	3-21
Power Factor Improving Reactor.....	3-22
Servo Support Software .....	3-23

## Options/Peripheral Equipment

## Basic Cable Configurations for Servo Motors

Necessary optional cables and connectors vary depending on the servo motor series.  
Refer to the following tables for necessary options.

### Selecting options for servo motor

Use the cables in the following tables.

For the cable descriptions, refer to the relevant numbers in each list.

Capacity	Servo motor	Reference list		
		Encoder cable	Servo motor power cable	Electromagnetic brake cable <sup>(Note 1)</sup>
Small capacity	HF-KN	Column A in encoder cable list	Column A in servo motor power cable list	Column A in electromagnetic brake cable list
Medium capacity	HF-SN	Column B in encoder cable list	Column B in servo motor power cable list	Column B in electromagnetic brake cable list

Notes: 1. An electromagnetic brake cable is required only for servo motor with electromagnetic brake.

### Encoder cable list

	Cable length	IP rating <sup>(Note 1)</sup>	Cable lead out direction	Bending life	Model	Reference	Note
A	10 m or shorter (direct connection type)	IP65	In direction of load side	Long bending life	MR-J3ENCBL_M-A1-H	p. 3-5	
				Standard	MR-J3ENCBL_M-A1-L		
			In opposite direction of load side	Long bending life	MR-J3ENCBL_M-A2-H	p. 3-5	
				Standard	MR-J3ENCBL_M-A2-L		
	Exceeding 10 m (junction type)	IP20	In direction of load side	Long bending life	Two types of cables are required: MR-J3JCBL03M-A1-L, MR-EKCBL_M-H	p. 3-5	
				Standard	Two types of cables are required: MR-J3JCBL03M-A1-L, MR-EKCBL_M-L		
			In opposite direction of load side	Long bending life	Two types of cables are required: MR-J3JCBL03M-A2-L, MR-EKCBL_M-H	p. 3-5	
				Standard	Two types of cables are required: MR-J3JCBL03M-A2-L, MR-EKCBL_M-L		
IP65	In direction of load side	Long bending life	Two types of cables are required: MR-J3JSCBL03M-A1-L, MR-J3ENSCBL_M-H	pp. 3-5 and 3-6			
		Standard	Two types of cables are required: MR-J3JSCBL03M-A1-L, MR-J3ENSCBL_M-L				
	In opposite direction of load side	Long bending life	Two types of cables are required: MR-J3JSCBL03M-A2-L, MR-J3ENSCBL_M-H	pp. 3-5 and 3-6			
		Standard	Two types of cables are required: MR-J3JSCBL03M-A2-L, MR-J3ENSCBL_M-L				
B	2 m to 50 m	IP67	-	Long bending life	MR-J3ENSCBL_M-H	p. 3-6	
	2 m to 30 m			Standard	MR-J3ENSCBL_M-L		

Notes: 1. The IP rating indicated is for the connector's protection against ingress of dust and water when coupled to a servo amplifier/servo motor. If the IP rating of the servo amplifier/servo motor differs from that of these connectors, overall IP rating depends on the lowest of all.



Servo motor power cable list

	Cable length	IP rating <sup>(Note 1)</sup>	Cable lead out direction	Bending life	Model	Reference	Note
A	10 m or shorter (direct connection type)	IP65	In direction of load side	Long bending life	MR-PWS1CBL_M-A1-H	p. 3-7	Select one from this list.
				Standard	MR-PWS1CBL_M-A1-L		
	In opposite direction of load side	Long bending life	MR-PWS1CBL_M-A2-H	p. 3-7			
		Standard	MR-PWS1CBL_M-A2-L				
Exceeding 10 m (junction type)	IP55	In direction of load side	Standard	Connect a user-fabricated cable to MR-PWS2CBL03M-A1-L (optional cable).		p. 3-7	
				In opposite direction of load side	Connect a user-fabricated cable to MR-PWS2CBL03M-A2-L (optional cable).		p. 3-7

	IP rating <sup>(Note 1)</sup>	Compatible servo motor	Model	Reference	Note
B	IP67	HF-SN52J, 102J, 152J	Fabricate a cable that fits to MR-PWCNS4 (optional connector set).	p. 3-7	Select one that is compatible with the servo motor.
		HF-SN202J, 302J	Fabricate a cable that fits to MR-PWCNS5 (optional connector set).	p. 3-7	

Electromagnetic brake cable list

	Cable length	IP rating <sup>(Note 1)</sup>	Cable lead out direction	Bending life	Model	Reference	Note
A	10 m or shorter (direct connection type)	IP65	In direction of load side	Long bending life	MR-BKS1CBL_M-A1-H	p. 3-8	Select one from this list.
				Standard	MR-BKS1CBL_M-A1-L		
	In opposite direction of load side	Long bending life	MR-BKS1CBL_M-A2-H	p. 3-8			
		Standard	MR-BKS1CBL_M-A2-L				
Exceeding 10 m (junction type)	IP55	In direction of load side	Standard	Connect a user-fabricated cable to MR-BKS2CBL03M-A1-L (optional cable).		p. 3-8	
				In opposite direction of load side	Connect a user-fabricated cable to MR-BKS2CBL03M-A2-L (optional cable).		p. 3-8

	IP rating <sup>(Note 1)</sup>	Compatible servo motor	Model	Reference	Note
B	IP67	HF-SN series	Fabricate a cable that fits to MR-BKCNS1 (optional connector set) (straight type).	p. 3-8	Select one from this list.
			Fabricate a cable that fits to MR-BKCNS1A (optional connector set) (angle type).	p. 3-8	

Notes: 1. The IP rating indicated is for the connector's protection against ingress of dust and water when coupled to a servo amplifier/servo motor. If the IP rating of the servo amplifier/servo motor differs from that of these connectors, overall IP rating depends on the lowest of all.

## Configuration Example for Servo Motors

For HF-KN servo motor series: encoder cable length 10 m or shorter

- For leading the cables out in direction of load side (Note 1)

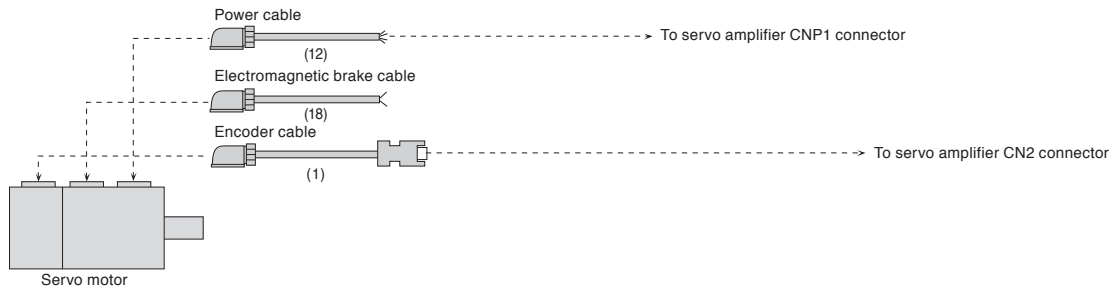

- For leading the cables out in opposite direction of load side (Note 1)

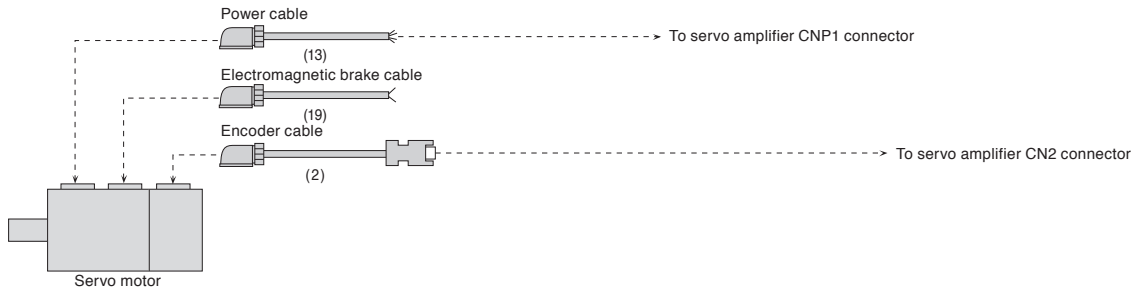

Notes: 1. Cables for leading two different directions may be used for one servo motor.



### Configuration Example for Servo Motors (Note 5)

For HF-KN servo motor series: encoder cable length over 10 m

● For leading the cables out in direction of load side (Note 4)

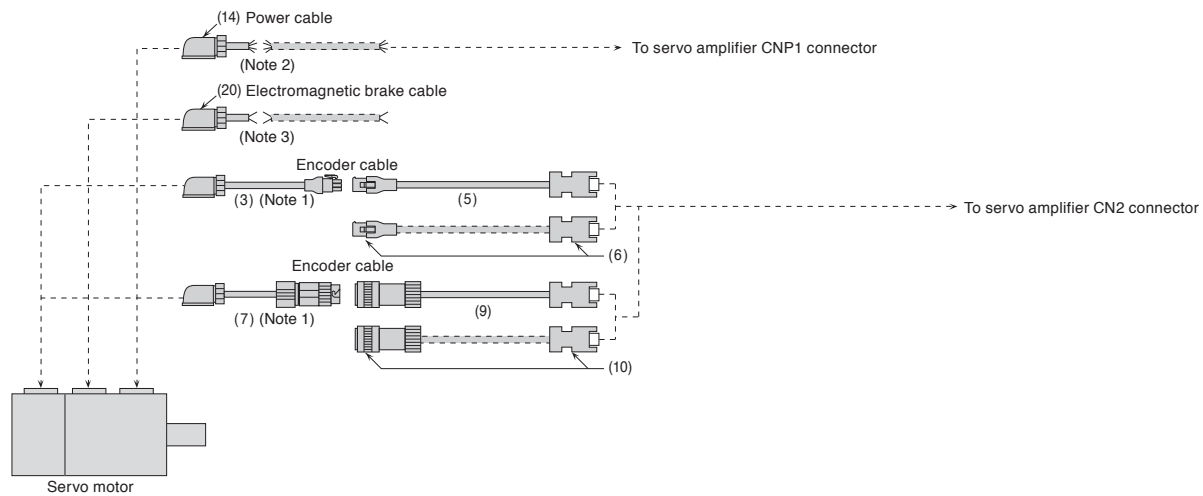

● For leading the cables out in opposite direction of load side (Note 4)

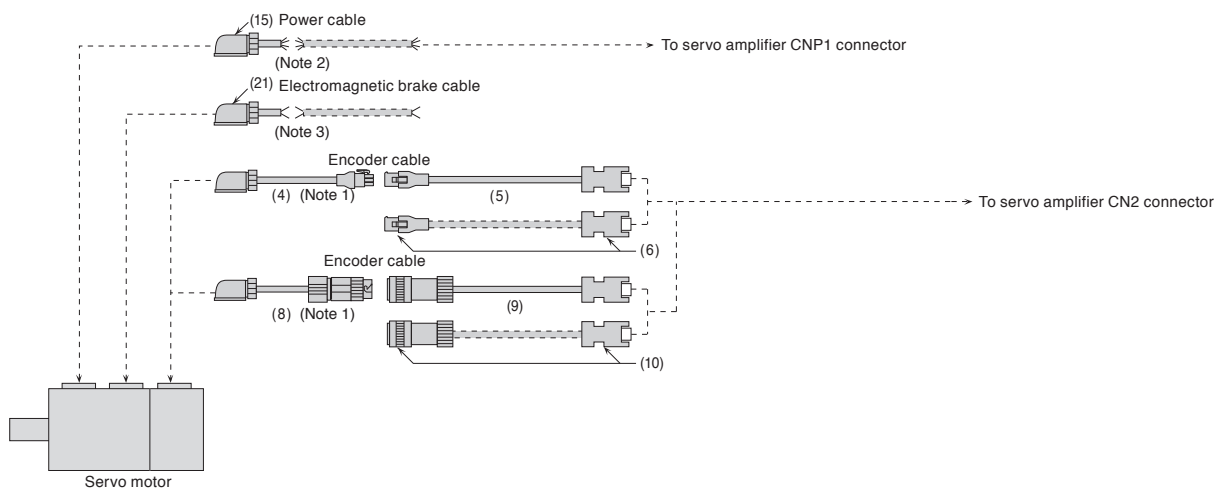



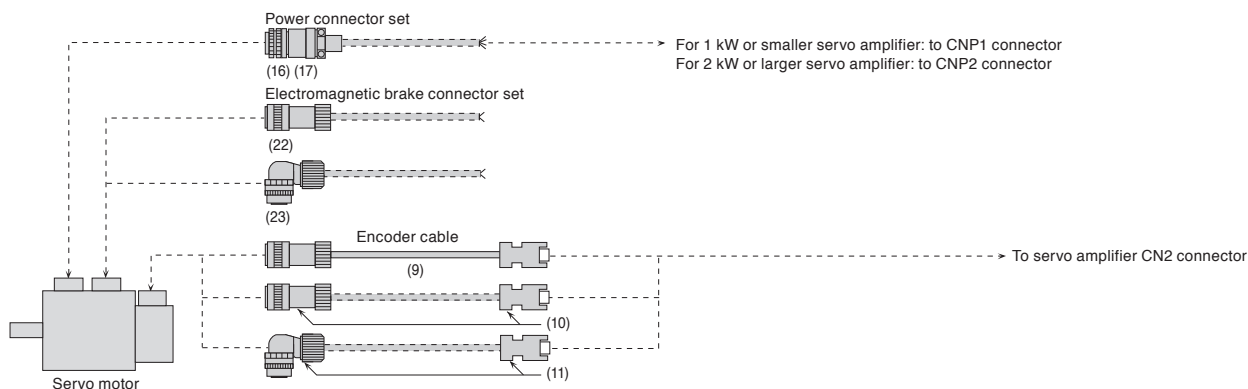

For HF-SN servo motor series



- Notes: 1. This cable does not have a long bending life. Thus, be sure to fix the cable before using.  
 2. Relay a cable using MR-PWS2CBL03M-A1-L or MR-PWS2CBL03M-A2-L. This cable does not have a long bending life. Thus, be sure to fix the cable before using.  
 3. Relay a cable using MR-BKS2CBL03M-A1-L or MR-BKS2CBL03M-A2-L. This cable does not have a long bending life. Thus, be sure to fix the cable before using.  
 4. Cables for leading two different directions may be used for one servo motor.  
 5. Cables drawn with dashed lines need to be fabricated by user. Refer to "HF-KN HF-SN Servo Motor Instruction Manual" for fabricating the cables.

## Cables and Connectors for Servo Motor Encoder

Refer to "Details of Optional Cables and Connectors for Servo Motors" in this catalog for the detailed models.

Item	Model	Cable length	IP rating (Note 1)	Application	Description
(1) Encoder cable (Note 2) (load-side lead)	MR-J3ENCBL2M-A1-H *1	2 m	IP65	For HF-KN (direct connection type)	Encoder connector    Servo amplifier connector 
	MR-J3ENCBL5M-A1-H *1	5 m			
	MR-J3ENCBL10M-A1-H *1	10 m			
	MR-J3ENCBL2M-A1-L *1	2 m			
	MR-J3ENCBL5M-A1-L *1	5 m			
	MR-J3ENCBL10M-A1-L *1	10 m			
(2) Encoder cable (Note 2) (opposite to load-side lead)	MR-J3ENCBL2M-A2-H *1	2 m	IP65	For HF-KN (direct connection type)	
	MR-J3ENCBL5M-A2-H *1	5 m			
	MR-J3ENCBL10M-A2-H *1	10 m			
	MR-J3ENCBL2M-A2-L *1	2 m			
	MR-J3ENCBL5M-A2-L *1	5 m			
	MR-J3ENCBL10M-A2-L *1	10 m			
(3) Encoder cable (Note 2) (load-side lead)	MR-J3JCBL03M-A1-L *1	0.3 m	IP20	For HF-KN (junction type)	Encoder connector    Junction connector 
(4) Encoder cable (Note 2) (opposite to load-side lead)	MR-J3JCBL03M-A2-L *1	0.3 m	IP20	For HF-KN (junction type)	Use this in combination with (5) or (6).
(5) Encoder cable (Note 2)	MR-EKCBL20M-H *1	20 m	IP20	For HF-KN (junction type)	Junction connector    Servo amplifier connector  Use this in combination with (3) or (4).
	MR-EKCBL30M-H (Note 3) *1	30 m			
	MR-EKCBL40M-H (Note 3) *1	40 m			
	MR-EKCBL50M-H (Note 3) *1	50 m			
	MR-EKCBL20M-L *1	20 m			
	MR-EKCBL30M-L (Note 3) *1	30 m			
(6) Encoder connector set	MR-ECNM	-	IP20	For HF-KN (junction type)	Junction connector    Servo amplifier connector  Use this in combination with (3) or (4).  Applicable cable Wire size: 0.3 mm <sup>2</sup> (AWG 22) Cable OD: 8.2 mm Crimping tool (91529-1) is required.
(7) Encoder cable (Note 2) (load-side lead)	MR-J3JSCBL03M-A1-L *1	0.3 m	IP65 (Note 4)	For HF-KN (junction type)	Encoder connector    Junction connector 
(8) Encoder cable (Note 2) (opposite to load-side lead)	MR-J3JSCBL03M-A2-L *1	0.3 m	IP65 (Note 4)	For HF-KN (junction type)	Use this in combination with (9) or (10).

Notes: 1. The IP rating indicated is for the connector's protection against ingress of dust and water when coupled to a servo amplifier/servo motor. If the IP rating of the servo amplifier/servo motor differs from that of these connectors, overall IP rating depends on the lowest of all.

2. -H and -L indicate a bending life. -H indicates a long bending life, and -L indicates a standard bending life.

3. This encoder cable is available in four-wire type. Parameter setting is required to use the four-wire type encoder cable. Refer to "MR-JE-\_A Servo Amplifier Instruction Manual" for details.

4. The encoder cable is rated IP65 while the junction connector itself is rated IP67.



For unlisted lengths

\*1. For unlisted lengths of the cables, contact Mitsubishi Electric System & Service Co., Ltd. FA PRODUCT DIVISION by email: oss-ip@melsc.jp



## Cables and Connectors for Servo Motor Encoder

Refer to "Details of Optional Cables and Connectors for Servo Motors" in this catalog for the detailed models.

Item	Model	Cable length	IP rating (Note 1)	Application	Description
(9) Encoder cable (Note 2)	MR-J3ENSCBL2M-H <sup>*1</sup>	2 m	IP67	For HF-KN (junction type) For HF-SN (direct connection type)	Junction connector or encoder connector      Servo amplifier connector  Use this in combination with (7) or (8) for HF-KN series.
	MR-J3ENSCBL5M-H <sup>*1</sup>	5 m			
	MR-J3ENSCBL10M-H <sup>*1</sup>	10 m			
	MR-J3ENSCBL20M-H <sup>*1</sup>	20 m			
	MR-J3ENSCBL30M-H <sup>*1</sup>	30 m			
	MR-J3ENSCBL40M-H <sup>*1</sup>	40 m			
	MR-J3ENSCBL50M-H <sup>*1</sup>	50 m			
	MR-J3ENSCBL2M-L <sup>*1</sup>	2 m			
	MR-J3ENSCBL5M-L <sup>*1</sup>	5 m			
	MR-J3ENSCBL10M-L <sup>*1</sup>	10 m			
	MR-J3ENSCBL20M-L <sup>*1</sup>	20 m			
MR-J3ENSCBL30M-L <sup>*1</sup>	30 m				
(10) Encoder connector set (one-touch connection type)	MR-J3SCNS	-	IP67	For HF-KN (junction type) For HF-SN (direct connection type) (straight type)	Junction connector or encoder connector      Servo amplifier connector  Use this in combination with (7) or (8) for HF-KN series.  Applicable cable Wire size: 0.5 mm <sup>2</sup> (AWG 20) or smaller Cable OD: 5.5 mm to 9.0 mm (Note 3)
(11) Encoder connector set (one-touch connection type)	MR-J3SCNSA <sup>*2</sup>	-	IP67	For HF-SN (angle type)	Encoder connector      Servo amplifier connector  Applicable cable Wire size: 0.5 mm <sup>2</sup> (AWG 20) or smaller Cable OD: 5.5 mm to 9.0 mm (Note 3)





Notes: 1. The IP rating indicated is for the connector's protection against ingress of dust and water when coupled to a servo amplifier/servo motor. If the IP rating of the servo amplifier/servo motor differs from that of these connectors, overall IP rating depends on the lowest of all.  
 2. -H and -L indicate a bending life. -H indicates a long bending life, and -L indicates a standard bending life.  
 3. Cable clamps and bushings for cable OD of 5.5 mm to 7.5 mm and of 7.0 mm to 9.0 mm are included in the set.

For unlisted lengths and fabricating cables

\*1. For unlisted lengths of the cables, contact Mitsubishi Electric System & Service Co., Ltd. FA PRODUCT DIVISION by email: oss-ip@melsc.jp  
 \*2. For fabricating encoder cables with these connectors, contact Mitsubishi Electric System & Service Co., Ltd. FA PRODUCT DIVISION by email: oss-ip@melsc.jp

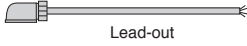
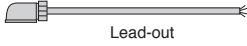
## Cables and Connectors for Servo Motor Power

Refer to "Details of Optional Cables and Connectors for Servo Motors" in this catalog for the detailed models.

Item	Model	Cable length	IP rating (Note 1)	Application	Description
(12) Power cable (Note 2) (load-side lead)	MR-PWS1CBL2M-A1-H <sup>*1</sup>	2 m	IP65	For HF-KN (direct connection type)	 Power connector Lead-out
	MR-PWS1CBL5M-A1-H <sup>*1</sup>	5 m			
	MR-PWS1CBL10M-A1-H <sup>*1</sup>	10 m			
	MR-PWS1CBL2M-A1-L <sup>*1 (Note 3)</sup>	2 m			
	MR-PWS1CBL5M-A1-L <sup>*1 (Note 3)</sup>	5 m			
	MR-PWS1CBL10M-A1-L <sup>*1 (Note 3)</sup>	10 m			
(13) Power cable (Note 2) (opposite to load-side lead)	MR-PWS1CBL2M-A2-H <sup>*1</sup>	2 m	IP65	For HF-KN (direct connection type)	 Power connector Lead-out  * The cable is not shielded.
	MR-PWS1CBL5M-A2-H <sup>*1</sup>	5 m			
	MR-PWS1CBL10M-A2-H <sup>*1</sup>	10 m			
	MR-PWS1CBL2M-A2-L <sup>*1 (Note 3)</sup>	2 m			
	MR-PWS1CBL5M-A2-L <sup>*1 (Note 3)</sup>	5 m			
	MR-PWS1CBL10M-A2-L <sup>*1 (Note 3)</sup>	10 m			
(14) Power cable (Note 2) (load-side lead)	MR-PWS2CBL03M-A1-L	0.3 m	IP55	For HF-KN (junction type)	 Power connector Lead-out * The cable is not shielded.
(15) Power cable (Note 2) (opposite to load-side lead)	MR-PWS2CBL03M-A2-L	0.3 m	IP55	For HF-KN (junction type)	 Power connector Lead-out * The cable is not shielded.
(16) Power connector set	MR-PWCNS4 <sup>*2</sup>	-	IP67	For HF-SN52J, 102J, 152J	 Power connector  Applicable cable Wire size: 2 mm <sup>2</sup> to 3.5 mm <sup>2</sup> (AWG 14 to 12) Cable OD: 10.5 mm to 14.1 mm
(17) Power connector set	MR-PWCNS5 <sup>*2</sup>	-	IP67	For HF-SN202J, 302J	 Power connector  Applicable cable Wire size: 5.5 mm <sup>2</sup> to 8 mm <sup>2</sup> (AWG 10 to 8) Cable OD: 12.5 mm to 16 mm

Notes: 1. The IP rating indicated is for the connector's protection against ingress of dust and water when coupled to a servo amplifier/servo motor. If the IP rating of the servo amplifier/servo motor differs from that of these connectors, overall IP rating depends on the lowest of all.

2. -H and -L indicate a bending life. -H indicates a long bending life, and -L indicates a standard bending life.

3. Shielded power cable MR-PWS3CBL\_M-A\_-L is also available. Contact your local sales office.

For unlisted lengths and fabricating cables

\*1. For unlisted lengths of the cables, contact Mitsubishi Electric System & Service Co., Ltd. FA PRODUCT DIVISION by email: oss-ip@melsc.jp

\*2. For fabricating power cables and electromagnetic brake cables, contact Mitsubishi Electric System & Service Co., Ltd. FA PRODUCT DIVISION by email: oss-ip@melsc.jp





## Cables and Connectors for Servo Motor Electromagnetic Brake

Refer to "Details of Optional Cables and Connectors for Servo Motors" in this catalog for the detailed models.

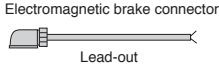
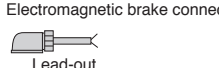
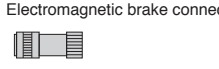
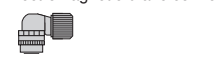

Item	Model	Cable length	IP rating (Note 1)	Application	Description
(18) Electromagnetic brake cable (Note 2) (load-side lead)	MR-BKS1CBL2M-A1-H <sup>*1</sup>	2 m	IP65	For HF-KN (direct connection type)	 Electromagnetic brake connector Lead-out
	MR-BKS1CBL5M-A1-H <sup>*1</sup>	5 m			
	MR-BKS1CBL10M-A1-H <sup>*1</sup>	10 m			
	MR-BKS1CBL2M-A1-L <sup>*1</sup>	2 m			
	MR-BKS1CBL5M-A1-L <sup>*1</sup>	5 m			
	MR-BKS1CBL10M-A1-L <sup>*1</sup>	10 m			
(19) Electromagnetic brake cable (Note 2) (opposite to load-side lead)	MR-BKS1CBL2M-A2-H <sup>*1</sup>	2 m	IP65	For HF-KN (direct connection type)	* The cable is not shielded.
	MR-BKS1CBL5M-A2-H <sup>*1</sup>	5 m			
	MR-BKS1CBL10M-A2-H <sup>*1</sup>	10 m			
	MR-BKS1CBL2M-A2-L <sup>*1</sup>	2 m			
	MR-BKS1CBL5M-A2-L <sup>*1</sup>	5 m			
	MR-BKS1CBL10M-A2-L <sup>*1</sup>	10 m			
(20) Electromagnetic brake cable (Note 2) (load-side lead)	MR-BKS2CBL03M-A1-L	0.3 m	IP55	For HF-KN (junction type)	 Electromagnetic brake connector Lead-out * The cable is not shielded.
(21) Electromagnetic brake cable (Note 2) (opposite to load-side lead)	MR-BKS2CBL03M-A2-L	0.3 m	IP55	For HF-KN (junction type)	
(22) Electromagnetic brake connector set (one-touch connection type)	MR-BKCNS1 <sup>*2</sup>	-	IP67	For HF-SN (straight type)	 Electromagnetic brake connector Applicable cable Wire size: 1.25 mm <sup>2</sup> (AWG 16) or smaller Cable OD: 9.0 mm to 11.6 mm
(23) Electromagnetic brake connector set (one-touch connection type)	MR-BKCNS1A <sup>*2</sup>	-	IP67	For HF-SN (angle type)	 Electromagnetic brake connector Applicable cable Wire size: 1.25 mm <sup>2</sup> (AWG 16) or smaller Cable OD: 9.0 mm to 11.6 mm



Notes: 1. The IP rating indicated is for the connector's protection against ingress of dust and water when coupled to a servo amplifier/servo motor. If the IP rating of the servo amplifier/servo motor differs from that of these connectors, overall IP rating depends on the lowest of all.  
 2. -H and -L indicate a bending life. -H indicates a long bending life, and -L indicates a standard bending life.



For unlisted lengths and fabricating cables



\*1. For unlisted lengths of the cables, contact Mitsubishi Electric System & Service Co., Ltd. FA PRODUCT DIVISION by email: oss-ip@melsc.jp  
 \*2. For fabricating power cables and electromagnetic brake cables, contact Mitsubishi Electric System & Service Co., Ltd. FA PRODUCT DIVISION by email: oss-ip@melsc.jp



## Details of Optional Cables and Connectors for Servo Motors



Model	Encoder connector	Servo amplifier connector
MR-J3ENCBL_M-A1-H (Note 2) MR-J3ENCBL_M-A1-L (Note 2) MR-J3ENCBL_M-A2-H (Note 2) MR-J3ENCBL_M-A2-L (Note 2)	 2174053-1 (TE Connectivity Ltd. Company)	 Receptacle: 36210-0100PL Shell kit: 36310-3200-008 (3M) or Connector set: 54599-1019 (Molex)

Model	Encoder connector	Junction connector
MR-J3JCBLO3M-A1-L (Note 2) MR-J3JCBLO3M-A2-L (Note 2)	 2174053-1 (TE Connectivity Ltd. Company)	 Contact: 1473226-1 (with ring) Housing: 1-172169-9 Cable clamp: 316454-1 (TE Connectivity Ltd. Company)

Model	Junction connector	Servo amplifier connector
MR-EKCBL_M-H MR-EKCBL_M-L MR-ECNM	 Housing: 1-172161-9 Connector pin: 170359-1 (TE Connectivity Ltd. Company) or an equivalent product Cable clamp: MTI-0002 (Toa Electric Industrial Co., Ltd.)	 Receptacle: 36210-0100PL Shell kit: 36310-3200-008 (3M) or Connector set: 54599-1019 (Molex)

Model	Encoder connector	Junction connector
MR-J3JSCBLO3M-A1-L (Note 2) MR-J3JSCBLO3M-A2-L (Note 2)	 2174053-1 (TE Connectivity Ltd. Company)	 Cable receptacle: CM10-CR10P-M (DDK Ltd.)



Model	Encoder connector	Servo amplifier connector
MR-J3ENSABL_M-H (Note 2) MR-J3ENSABL_M-L (Note 2)	 For 10 m or shorter cable Straight plug: CMV1-SP10S-M1 Socket contact: CMV1-#22ASC-C1-100 For 20 m or longer cable Straight plug: CMV1-SP10S-M1 (long bending life) CMV1-SP10S-M2 (standard) Socket contact: CMV1-#22ASC-C2-100 (DDK Ltd.)	 Receptacle: 36210-0100PL Shell kit: 36310-3200-008 (3M) or Connector set: 54599-1019 (Molex)

Model	Junction connector or encoder connector	Servo amplifier connector
MR-J3SCNS (Note 2)	 Straight plug: CMV1-SP10S-M2 (Note 1) Socket contact: CMV1-#22ASC-S1-100 (DDK Ltd.)	 Receptacle: 36210-0100PL Shell kit: 36310-3200-008 (3M) or Connector set: 54599-1019 (Molex)

Notes: 1. Cable clamps and bushings for cable OD of 5.5 mm to 7.5 mm and of 7.0 mm to 9.0 mm are included in the set.  
2. The cable or the connector set may contain different connectors but still usable.



## Details of Optional Cables and Connectors for Servo Motors

Model	Encoder connector	Servo amplifier connector
MR-J3SCNSA (Note 2)	 Angle plug: CMV1-AP10S-M2 (Note 1) Socket contact: CMV1-#22ASC-S1-100 (DDK Ltd.)	 Receptacle: 36210-0100PL Shell kit: 36310-3200-008 (3M) or Connector set: 54599-1019 (Molex)

Model	Power connector
MR-PWS1CBL_M-A1-H (Note 2) MR-PWS1CBL_M-A1-L (Note 2) MR-PWS1CBL_M-A2-H (Note 2) MR-PWS1CBL_M-A2-L (Note 2)	 Plug: KN4FT04SJ1-R Socket contact: ST-TMH-S-C1B-100-(A534G) (Japan Aviation Electronics Industry, Limited)

Model	Power connector
MR-PWS2CBL03M-A1-L (Note 2) MR-PWS2CBL03M-A2-L (Note 2)	 Plug: KN4FT04SJ2-R Socket contact: ST-TMH-S-C1B-100-(A534G) (Japan Aviation Electronics Industry, Limited)

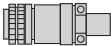
Model	Power connector
MR-PWCNS4	 Plug: CE05-6A18-10SD-D-BSS (straight) Cable clamp: CE3057-10A-1-D (DDK Ltd.)

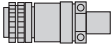
Model	Power connector
MR-PWCNS5	 Plug: CE05-6A22-22SD-D-BSS (straight) Cable clamp: CE3057-12A-1-D (DDK Ltd.)

Model	Electromagnetic brake connector
MR-BKS1CBL_M-A1-H MR-BKS1CBL_M-A1-L MR-BKS1CBL_M-A2-H MR-BKS1CBL_M-A2-L	 Plug: JN4FT02SJ1-R Socket contact: ST-TMH-S-C1B-100-(A534G) (Japan Aviation Electronics Industry, Limited)

Model	Electromagnetic brake connector
MR-BKS2CBL03M-A1-L MR-BKS2CBL03M-A2-L	 Plug: JN4FT02SJ2-R Socket contact: ST-TMH-S-C1B-100-(A534G) (Japan Aviation Electronics Industry, Limited)

Model	Electromagnetic brake connector
MR-BKCNS1 (Note 2)	 Straight plug: CMV1-SP2S-L Socket contact: CMV1-#22BSC-S2-100 (DDK Ltd.)

Model	Electromagnetic brake connector
MR-BKCNS1A (Note 2)	 Angle plug: CMV1-AP2S-L Socket contact: CMV1-#22BSC-S2-100 (DDK Ltd.)

Notes: 1. Cable clamps and bushings for cable OD of 5.5 mm to 7.5 mm and of 7.0 mm to 9.0 mm are included in the set.  
 2. The cable or the connector set may contain different connectors but still usable.

## Products on the Market for Servo Motors

Contact the relevant manufacturers directly.

When fabricating a cable with the following connectors, refer to the relevant manufacturers' instruction manuals for wiring and assembling procedures.

### Encoder connector (servo amplifier-side)



Application	Connector (3M)
Servo amplifier CN2 connector	Receptacle: 36210-0100PL Shell kit: 36310-3200-008
	Connector (Molex)
	54599-1019 (gray)
	54599-1016 (black)

### Encoder connector for HF-KN series



Applicable servo motor	Feature <sup>(Note 1)</sup>	Connector (TE Connectivity Ltd. Company)	Crimping tools (TE Connectivity Ltd. Company)	Applicable cable example
HF-KN	IP65	2174053-1	For ground clip: 1596970-1 For receptacle contact: 1596847-1	Wire size: 0.13 mm <sup>2</sup> to 0.33 mm <sup>2</sup> (AWG 26 to 22) Cable OD: 6.8 mm to 7.4 mm Wire example: Fluorine resin wire (Vinyl jacket cable TPE. SVP 70/0.08(AWG#22)-3P KB-2237-2 Bando Densen Co., Ltd. <sup>(Note 2)</sup> or an equivalent product)

Straight type

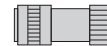

Angle type



### Encoder connector for HF-SN series

Applicable servo motor	Feature <sup>(Note 1)</sup>	Connector (DDK Ltd.)				Applicable cable example Cable OD [mm]
		Type	Type of connection	Plug	Socket contact	
HF-SN	IP67	Straight	One-touch connection type	CMV1-SP10S-M1	Select from solder or press bonding type. (Refer to the table below.)	5.5 to 7.5
				CMV1-SP10S-M2		7.0 to 9.0
		Angle	One-touch connection type	CMV1-AP10S-M1		5.5 to 7.5
				CMV1-AP10S-M2		7.0 to 9.0

Contact	Socket contact (DDK Ltd.)	Wire size <sup>(Note 3)</sup>
Solder type	CMV1-#22ASC-S1-100	0.5 mm <sup>2</sup> (AWG 20) or smaller
Press bonding type	CMV1-#22ASC-C1-100	0.2 mm <sup>2</sup> to 0.5 mm <sup>2</sup> (AWG 24 to 20) Crimping tool (357J-53162T) is required.
	CMV1-#22ASC-C2-100	0.08 mm <sup>2</sup> to 0.2 mm <sup>2</sup> (AWG 28 to 24) Crimping tool (357J-53163T) is required.

Notes: 1. The IP rating indicated is for the connector's protection against ingress of dust and water when coupled to a servo amplifier/servo motor. If the IP rating of the servo amplifier/servo motor differs from that of these connectors, overall IP rating depends on the lowest of all.

2. Contact Toa Electric Industrial Co., Ltd.

3. The wire size shows wiring specification of the connector.



## Products on the Market for Servo Motors

### Application of connecting encoder junction cable

Unlisted lengths of cables between servo amplifier and servo motor, EMC cables, and special cables for connecting servo amplifier and servo motor with multiple cables are available. Contact Mitsubishi Electric System & Service Co., Ltd. FA PRODUCT DIVISION by email: [oss-ip@melsc.jp](mailto:oss-ip@melsc.jp)

Example) Configuration using three encoder junction cables

- Replacing only the cable of the moving part in the cable chain is possible.
- Resetting after transporting a machine is easy because the servo amplifier side and the servo motor side can be separated.

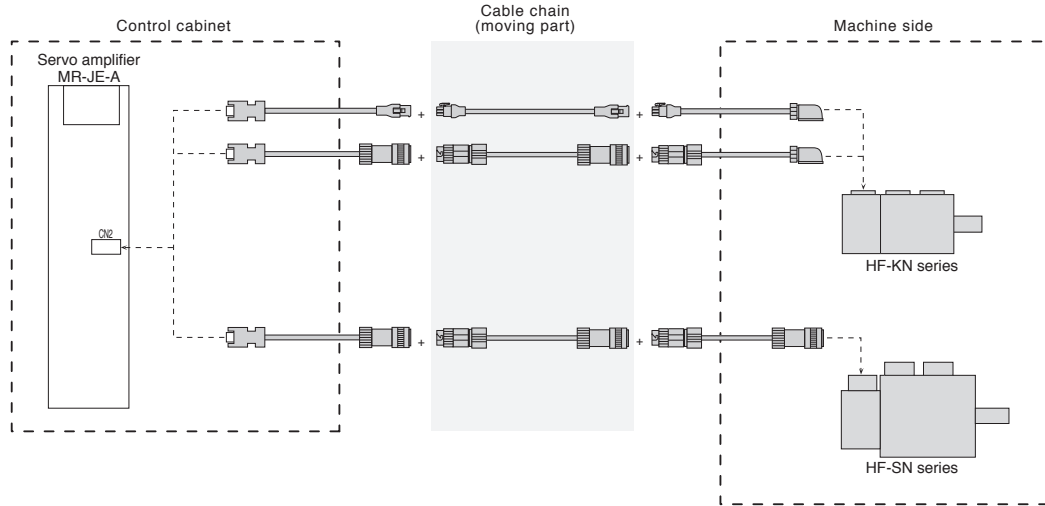

## Products on the Market for Servo Motors

Contact the relevant manufacturers directly.

When fabricating a cable with the following connectors, refer to the relevant manufacturers' instruction manuals for wiring and assembling procedures.

### Power connector for HF-KN series



Applicable servo motor	Feature (Note 1)	Connector (Japan Aviation Electronics Industry, Limited)	Crimping tools (Japan Aviation Electronics Industry, Limited)	Applicable cable example
HF-KN	IP65	Plug: KN4FT04SJ1-R Socket contact: ST-TMH-S-C1B-100-(A534G)	For contactor: CT160-3-TMH5B	Wire size: 0.3 mm <sup>2</sup> to 0.75 mm <sup>2</sup> (AWG 22 to 18) Cable OD: 5.3 mm to 6.5 mm Wire example: Fluorine resin wire (Vinyl jacket cable RMFES-A (CL3X) AWG 19, 4 cores Dyden Corporation (Note 4) or an equivalent product)

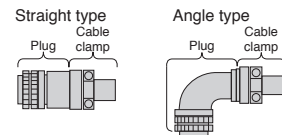

### Power connector for HF-SN series

Applicable servo motor	Feature (Note 1)	Plug (with backshell) (DDK Ltd.)		Cable clamp (DDK Ltd.)	Applicable cable example	
		Type	Model	Model	Wire size (Note 3)	Cable OD [mm]
HF-SN52J, 102J, 152J	IP67 EN compliant	Straight	CE05-6A18-10SD-D-BSS	CE3057-10A-2-D	2.2 mm <sup>2</sup> to 3.5 mm <sup>2</sup> (AWG 14 to 12)	8.5 to 11
	CE3057-10A-1-D			10.5 to 14.1		
General environment (Note 2)	D/MS3106B18-10S		D/MS3057-10A	2.2 mm <sup>2</sup> to 3.5 mm <sup>2</sup> (AWG 14 to 12)	14.3 or smaller (bushing ID)	
	HF-SN202J, 302J		IP67 EN compliant	CE05-6A22-22SD-D-BSS	CE3057-12A-2-D	5.5 mm <sup>2</sup> to 8 mm <sup>2</sup> (AWG 10 to 8)
CE3057-12A-1-D		12.5 to 16				
General environment (Note 2)	D/MS3106B22-22S	D/MS3057-12A	5.5 mm <sup>2</sup> to 8 mm <sup>2</sup> (AWG 10 to 8)	15.9 or smaller (bushing ID)		
	HF-SN52J, 102J, 152J	IP67 EN compliant	CE05-8A18-10SD-D-BAS	CE3057-10A-2-D	2.2 mm <sup>2</sup> to 3.5 mm <sup>2</sup> (AWG 14 to 12)	8.5 to 11
CE3057-10A-1-D		10.5 to 14.1				
General environment (Note 2)	D/MS3108B18-10S	D/MS3057-10A	2.2 mm <sup>2</sup> to 3.5 mm <sup>2</sup> (AWG 14 to 12)	14.3 or smaller (bushing ID)		
	HF-SN202J, 302J	IP67 EN compliant	CE05-8A22-22SD-D-BAS	CE3057-12A-2-D	5.5 mm <sup>2</sup> to 8 mm <sup>2</sup> (AWG 10 to 8)	9.5 to 13
CE3057-12A-1-D		12.5 to 16				
General environment (Note 2)	D/MS3108B22-22S	D/MS3057-12A	5.5 mm <sup>2</sup> to 8 mm <sup>2</sup> (AWG 10 to 8)	15.9 or smaller (bushing ID)		

Notes: 1. The IP rating indicated is for the connector's protection against ingress of dust and water when coupled to a servo amplifier/servo motor. If the IP rating of the servo amplifier/servo motor differs from that of these connectors, overall IP rating depends on the lowest of all.

2. Not compliant with EN.

3. The wire size shows wiring specification of the connector. Refer to "Selection Example in HIV Wires for Servo Motors" in this catalog for examples of wire size selection.

4. Contact Taisei Co., Ltd.



## Products on the Market for Servo Motors

Contact the relevant manufacturers directly.

When fabricating a cable with the following connectors, refer to the relevant manufacturers' instruction manuals for wiring and assembling procedures.

### Electromagnetic brake connector for HF-KN series



Applicable servo motor	Feature <sup>(Note 1)</sup>	Connector (Japan Aviation Electronics Industry, Limited)	Crimping tool (Japan Aviation Electronics Industry, Limited)	Applicable cable example
HF-KN	IP65	Plug: JN4FT02SJ1-R Socket contact: ST-TMH-S-C1B-100-(A534G)	For contactor: CT160-3-TMH5B	Wire size: 0.3 mm <sup>2</sup> to 0.5 mm <sup>2</sup> (AWG 22 to 20) Cable OD: 3.6 mm to 4.8 mm Wire example: Fluorine resin wire (Vinyl jacket cable RMFES-A (CL3X) AWG 20, 2 cores Dyden Corporation <sup>(Note 2)</sup> or an equivalent product)

Straight type      Angle type

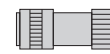

### Electromagnetic brake connector for HF-SN series

Applicable servo motor	Feature <sup>(Note 1)</sup>	Connector (DDK Ltd.)				Applicable cable example Cable OD [mm]
		Type	Type of connection	Plug	Socket contact	
HF-SN	IP67	Straight	One-touch connection type	CMV1-SP2S-S	Select from solder or press bonding type. (Refer to the table below.)	4.0 to 6.0
				CMV1-SP2S-M1		5.5 to 7.5
				CMV1-SP2S-M2		7.0 to 9.0
				CMV1-SP2S-L		9.0 to 11.6
		Angle	One-touch connection type	CMV1-AP2S-S		4.0 to 6.0
				CMV1-AP2S-M1		5.5 to 7.5
				CMV1-AP2S-M2		7.0 to 9.0
				CMV1-AP2S-L		9.0 to 11.6

Contact	Socket contact (DDK Ltd.)	Wire size <sup>(Note 3)</sup>
Solder type	CMV1-#22BSC-S2-100	1.25 mm <sup>2</sup> (AWG 16) or smaller
Press bonding type	CMV1-#22BSC-C3-100	0.5 mm <sup>2</sup> to 1.25 mm <sup>2</sup> (AWG 20 to 16) Crimping tool (357J-53164T) is required.

Notes: 1. The IP rating indicated is for the connector's protection against ingress of dust and water when coupled to a servo amplifier/servo motor. If the IP rating of the servo amplifier/servo motor differs from that of these connectors, overall IP rating depends on the lowest of all.

2. Contact Taisei Co., Ltd.

3. The wire size shows wiring specification of the connector. Refer to "Selection Example in HIV Wires for Servo Motors" in this catalog for examples of wire size selection.

## Configuration Example for Servo Amplifiers

### Servo amplifier 1 kW or smaller

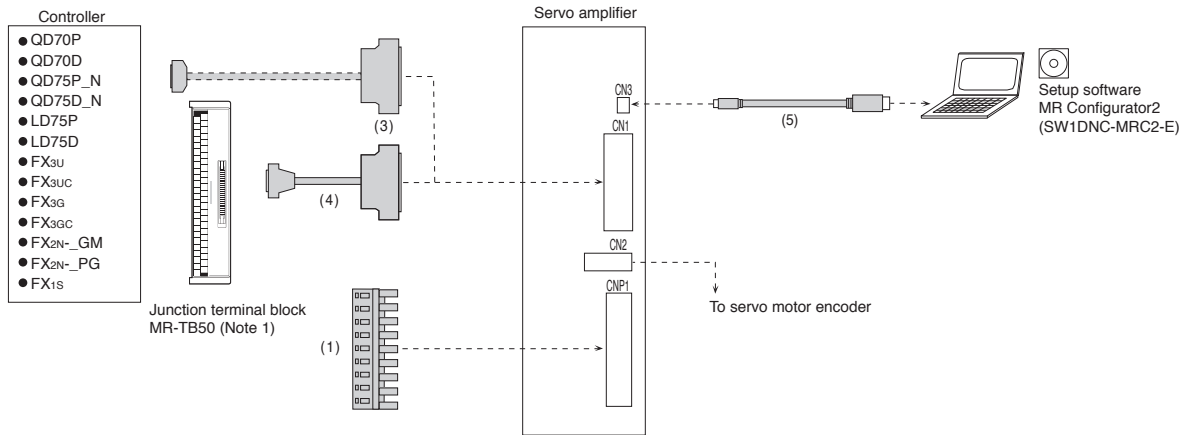

### Servo amplifier 2 kW and 3 kW

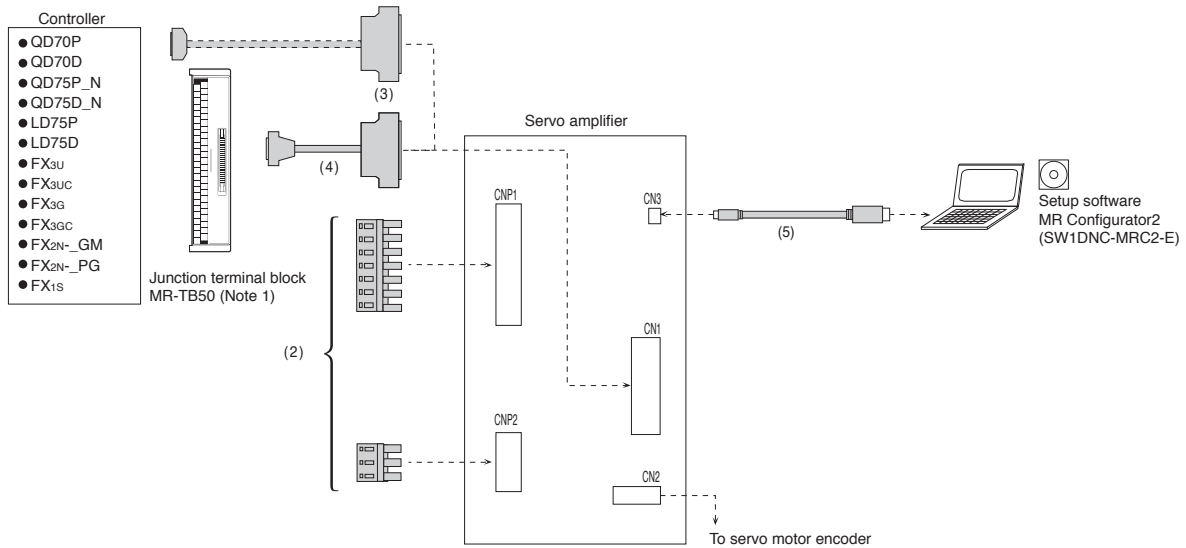









Notes: 1. Refer to "Junction Terminal Block" in this catalog.







## Cables and Connectors for Servo Amplifiers



Refer to "Details of Optional Cables and Connectors for Servo Amplifiers" in this catalog for the detailed models.

	Item	Model	Cable length	IP rating	Application	Description
For CNP1	(1) Servo amplifier CNP1 power connector (Note 2) (insertion type)	MR-JECNP1-01	-	-	For MR-JE-100A or smaller	<p>CNP1 connector  Open tool </p> <p>Applicable wire size (Note 1): AWG 18 to 14 Insulator OD: up to 3.9 mm</p>
	For CNP1/CNP2	(2) Servo amplifier CNP1 power connector (Note 2) (insertion type)	MR-JECNP1-02	-	-	For MR-JE-200A/ MR-JE-300A
Servo amplifier CNP2 power connector (Note 2) (insertion type)		MR-JECNP2-02	-	-	<p>CNP2 connector </p> <p>Applicable wire size (Note 1): AWG 16 to 10 Insulator OD: up to 4.7 mm</p>	
For CN1	(3) Connector set	MR-J3CN1	-	-	For MR-JE-A	 Servo amplifier connector
	(4) Junction terminal block cable	MR-J2M-CN1TBL05M MR-J2M-CN1TBL1M	0.5 m 1 m	-	For connecting MR-JE-A and MR-TB50	<p>Junction terminal block connector  Servo amplifier connector </p>
For CN3	(5) Personal computer communication cable (USB cable)	MR-J3USBCBL3M	3 m	-	For MR-JE-A	<p>Servo amplifier connector mini-B connector (5-pin)  Personal computer connector A connector </p>

Notes: 1. The wire size shows wiring specification of the connector. Refer to "Selection Example in HIV Wires for Servo Motors" in this catalog for examples of wire size selection.  
2. CNP1 and CNP2 connectors, and open tool are supplied with the servo amplifier.



## Details of Optional Cables and Connectors for Servo Amplifiers

Model	CNP1 connector	Open tool
MR-JECNP1-01 <small>(Note 2)</small>	 09JFAT-SAXGDK-H5.0 (J.S.T. Mfg. Co., Ltd.)	 J-FAT-OT (J.S.T. Mfg. Co., Ltd.)

Model	CNP1 connector	Open tool
MR-JECNP1-02 <small>(Note 2)</small>	 07JFAT-SAXGFS-XL (J.S.T. Mfg. Co., Ltd.)	 J-FAT-OT-EXL (J.S.T. Mfg. Co., Ltd.)

Model	CNP2 connector
MR-JECNP2-02 <small>(Note 2)</small>	 03JFAT-SAXGFK-XL (J.S.T. Mfg. Co., Ltd.)

Model	Servo amplifier connector
MR-J3CN1	 Connector: 10150-3000PE Shell kit: 10350-52F0-008 (3M) or an equivalent product

Model	Junction terminal block connector	Servo amplifier connector
MR-J2M-CN1TBL_M	 Connector: D7950-B500FL (3M)	 Press bonding type <small>(Note 1)</small> Connector: 10150-6000EL Shell kit: 10350-3210-000 (3M)

Notes: 1. Solder type (connector: 10150-3000PE and shell kit: 10350-52F0-008) (3M) is also usable. Contact the manufacturer directly.  
 2. CNP1 and CNP2 connectors, and open tool are supplied with the servo amplifier.



## Regenerative Option

Servo amplifier model	Tolerable regenerative power of built-in regenerative resistor [W]	Tolerable regenerative power of regenerative option [W] <sup>(Note 2)</sup>				
		MR-RB032	MR-RB12	MR-RB30	MR-RB32	MR-RB50 <sup>(Note 1)</sup>
		40 Ω	40 Ω	13 Ω	40 Ω	13 Ω
MR-JE-10A	-	30	-	-	-	-
MR-JE-20A	-	30	100	-	-	-
MR-JE-40A	10	30	100	-	-	-
MR-JE-70A	20	30	100	-	300	-
MR-JE-100A	20	30	100	-	300	-
MR-JE-200A	100	-	-	300	-	500
MR-JE-300A	100	-	-	300	-	500

Notes: 1. Be sure to cool the unit forcibly with a cooling fan (92 mm × 92 mm, minimum air flow: 1.0 m<sup>3</sup>/min). The cooling fan must be prepared by user.  
 2. The power values in this table are resistor-generated powers, not rated powers.

### \* Cautions when connecting the regenerative option

1. The regenerative option causes a temperature rise of 100 °C or higher relative to the ambient temperature. Fully examine heat dissipation, installation position, wires used before installing the unit. Use flame-retardant wires or apply flame retardant on wires, and keep the wires clear of the unit.
2. Use twisted wires for connecting the regenerative option to the servo amplifier, and keep the wire length to a maximum of 5 m.
3. Use twisted wires for connecting a thermal sensor, and make sure that the sensor does not fail to work properly due to inducted noise.

## Regenerative Option

Dimensions	[Unit: mm]	Connections									
<p><b>MR-RB032</b></p> <p>Terminal arrangement</p> <table border="1"> <tr><td>TE1</td></tr> <tr><td>G3</td></tr> <tr><td>G4</td></tr> <tr><td>P</td></tr> <tr><td>C</td></tr> </table> <p>Applicable wire size (Note 5): 0.2 mm<sup>2</sup> to 2.5 mm<sup>2</sup> (AWG 24 to 12) Mounting screw size: M5</p> <table border="1"> <thead> <tr> <th>Model</th> <th>Mass [kg]</th> </tr> </thead> <tbody> <tr> <td>MR-RB032</td> <td>0.5</td> </tr> </tbody> </table>	TE1	G3	G4	P	C	Model	Mass [kg]	MR-RB032	0.5		<p>Disconnect the wires for the built-in regenerative resistor (P+ and C) and remove the resistor.</p> <p>Servo amplifier</p> <p>Regenerative option</p> <p>Built-in regenerative resistor (Note 6)</p> <p>(Note 1)</p> <p>G3 (Note 4)</p> <p>G4 (Note 4)</p> <p>5 m or shorter</p>
TE1											
G3											
G4											
P											
C											
Model	Mass [kg]										
MR-RB032	0.5										
<p><b>MR-RB12</b></p> <p>Terminal arrangement</p> <table border="1"> <tr><td>TE1</td></tr> <tr><td>G3</td></tr> <tr><td>G4</td></tr> <tr><td>P</td></tr> <tr><td>C</td></tr> </table> <p>Applicable wire size (Note 5): 0.2 mm<sup>2</sup> to 2.5 mm<sup>2</sup> (AWG 24 to 12) Mounting screw size: M5</p> <table border="1"> <thead> <tr> <th>Model</th> <th>Mass [kg]</th> </tr> </thead> <tbody> <tr> <td>MR-RB12</td> <td>1.1</td> </tr> </tbody> </table>	TE1	G3	G4	P	C	Model	Mass [kg]	MR-RB12	1.1		<p>Disconnect the wires for the built-in regenerative resistor (P+ and C) and remove the resistor.</p> <p>Servo amplifier</p> <p>Regenerative option</p> <p>Built-in regenerative resistor (Note 6)</p> <p>(Note 1)</p> <p>G3 (Note 4)</p> <p>G4 (Note 4)</p> <p>5 m or shorter</p>
TE1											
G3											
G4											
P											
C											
Model	Mass [kg]										
MR-RB12	1.1										
<p><b>MR-RB30, MR-RB32</b></p> <p>Cooling fan mounting screw (2-M4 screw) (Note 3)</p> <p>Terminal arrangement</p> <table border="1"> <tr><td>P</td></tr> <tr><td>C</td></tr> <tr><td>G3</td></tr> <tr><td>G4</td></tr> </table> <p>Terminal screw size: M4 Mounting screw size: M6</p> <table border="1"> <thead> <tr> <th>Model</th> <th>Mass [kg]</th> </tr> </thead> <tbody> <tr> <td>MR-RB30</td> <td rowspan="2">2.9</td> </tr> <tr> <td>MR-RB32</td> </tr> </tbody> </table> <p>Cooling fan intake (Note 3)</p>	P	C	G3	G4	Model	Mass [kg]	MR-RB30	2.9	MR-RB32		<p><b>For MR-JE-100A or smaller</b></p> <p>Disconnect the wires for the built-in regenerative resistor (P+ and C) and remove the resistor.</p> <p>Servo amplifier</p> <p>Regenerative option</p> <p>Built-in regenerative resistor</p> <p>(Note 1)</p> <p>G3 (Note 4)</p> <p>G4 (Note 4)</p> <p>5 m or shorter</p> <p>Cooling fan (Note 3)</p>
P											
C											
G3											
G4											
Model	Mass [kg]										
MR-RB30	2.9										
MR-RB32											
<p><b>MR-RB50</b></p> <p>Cooling fan mounting screw (2-M3 screw) provided on the opposite side</p> <p>7 x 14 slotted hole</p> <p>Cooling fan intake</p> <p>Terminal arrangement</p> <table border="1"> <tr><td>P</td></tr> <tr><td>C</td></tr> <tr><td>G3</td></tr> <tr><td>G4</td></tr> </table> <p>Terminal screw size: M4 Mounting screw size: M6</p> <table border="1"> <thead> <tr> <th>Model</th> <th>Mass [kg]</th> </tr> </thead> <tbody> <tr> <td>MR-RB50</td> <td>5.6</td> </tr> </tbody> </table>	P	C	G3	G4	Model	Mass [kg]	MR-RB50	5.6		<p><b>For MR-JE-200A or larger</b></p> <p>Disconnect P+ and D.</p> <p>Servo amplifier</p> <p>Regenerative option</p> <p>(Note 1)</p> <p>G3 (Note 4)</p> <p>G4 (Note 4)</p> <p>5 m or shorter</p> <p>Cooling fan (Note 2)</p>	
P											
C											
G3											
G4											
Model	Mass [kg]										
MR-RB50	5.6										

- Notes: 1. Create a sequence circuit that turns off the magnetic contactor when abnormal overheating occurs.  
 2. When using MR-RB50, cool the unit forcibly with a cooling fan (92 mm × 92 mm, minimum air flow: 1.0 m<sup>3</sup>/min). The cooling fan must be prepared by user.  
 3. When using MR-RB30 or MR-RB32, it may be necessary to cool the unit forcibly with a cooling fan (92 mm × 92 mm, minimum air flow: 1.0 m<sup>3</sup>/min), depending on the operating environment. Refer to "MR-JE\_A Servo Amplifier Instruction Manual" for details. The cooling fan must be prepared by user.  
 4. G3 and G4 terminals are thermal sensor. G3-G4 opens when the regenerative option overheats abnormally.  
 5. Refer to "Wires, Molded-Case Circuit Breakers and Magnetic Contactors" in this catalog for examples of wire size selection.  
 6. MR-JE-10A and MR-JE-20A do not have the built-in regenerative resistor.



## Junction Terminal Block (MR-TB50)

Connect all signals via the junction terminal block.

Dimensions		[Unit: mm]
<p>Terminal screw size: M3.5                      Applicable wire: 2 mm<sup>2</sup> maximum                      Crimping terminal width: 7.2 mm or shorter                      Mounting screw size: M4</p>		

## Radio Noise Filter (FR-BIF)

This filter effectively controls noise emitted from the power supply side of the servo amplifier and is especially effective for radio frequency bands 10 MHz or lower. The FR-BIF is designed for the input only.

Dimensions	[Unit: mm]	Connections
		<p>The FR-BIF is designed to be connected with the input only. Wiring should be as short as possible. Grounding is required. Be sure to insulate the unused wire when using FR-BIF with 1-phase power.</p>

## Line Noise Filter (FR-BSF01)

This filter is effective in suppressing radio noise emitted from the power supply side or the output side of the servo amplifier, and also in suppressing high-frequency leakage current (zero-phase current), especially within 0.5 MHz to 5 MHz band.

Dimensions	[Unit: mm]	Connections
		<p>Use the line noise filter for wires of the power supply (L1, L2, and L3) of the servo amplifier, and of the motor power (U, V, and W). Pass each of the wires through the line noise filter equal times in a same direction. For the power supply, the effect of the filter rises as the number of passes increases, but generally four passes would be appropriate. For the servo motor power, passes must be four times or less. Do not pass the grounding wire through the filter. Otherwise, the effect of the filter is reduced. Wind the wires to pass through the filter as the required number of passes as shown in Fig.1. If the wires are too thick to wind, use two or more filters to have the required number of passes as shown in Fig.2. Place the line noise filters as close to the servo amplifier as possible for their best performance.</p> <p>Fig. 1</p> <p>Fig. 2</p>

## Data Line Filter

This filter is effective in preventing noise when attached to the pulse output cable of the pulse train output controller or the motor encoder cable.

Example ESD-SR-250 (manufactured by NEC TOKIN Corporation)  
 ZCAT3035-1330 (manufactured by TDK)  
 GRFC-13 (manufactured by Kitagawa Industries Co., Ltd.)

## Surge Killer

Attach surge killers to AC relays and AC valves around the servo amplifier. Attach diodes to DC relays and DC valves.

Example Surge killer: CR-50500 (manufactured by Okaya Electric Industries Co., Ltd.)  
 Diode: A diode with breakdown voltage four or more times greater than the relay drive voltage, and with current capacity two or more times greater than the relay drive current.

## EMC Filter

The following filters are recommended as a filter compliant with the EMC directive for the power supply of the servo amplifier.

Servo amplifier model	EMC filter model	Rated current [A]	Rated voltage [V AC]	Fig.
MR-JE-10A to 100A	HF3010A-UN (Note 1)	10	250	A
MR-JE-200A, 300A	HF3030A-UN (Note 1)	30	250	B

Notes: 1. Manufactured by Soshin Electric Co., Ltd.  
A surge protector is separately required to use this EMC filter. Refer to "EMC Installation Guidelines."

	Dimensions [Unit: mm]	Connections						
A	<p><b>HF3010A-UN</b></p> <table border="1"> <thead> <tr> <th>Model</th> <th>Leakage current [mA]</th> <th>Mass [kg]</th> </tr> </thead> <tbody> <tr> <td>HF3010A-UN</td> <td>5</td> <td>3.5</td> </tr> </tbody> </table>	Model	Leakage current [mA]	Mass [kg]	HF3010A-UN	5	3.5	<p>For 3-phase 200 V AC to 240 V AC</p>
Model	Leakage current [mA]	Mass [kg]						
HF3010A-UN	5	3.5						
B	<p><b>HF3030A-UN</b></p> <table border="1"> <thead> <tr> <th>Model</th> <th>Leakage current [mA]</th> <th>Mass [kg]</th> </tr> </thead> <tbody> <tr> <td>HF3030A-UN</td> <td>5</td> <td>5.5</td> </tr> </tbody> </table>	Model	Leakage current [mA]	Mass [kg]	HF3030A-UN	5	5.5	<p>For 1-phase 200 V AC to 240 V AC</p>
Model	Leakage current [mA]	Mass [kg]						
HF3030A-UN	5	5.5						



## Power Factor Improving AC Reactor (FR-HAL)

This boosts the power factor of servo amplifier and reduces the power supply capacity.

Servo amplifier model	Power factor improving AC reactor model	Fig.
MR-JE-10A	FR-HAL-0.4K	A
MR-JE-20A		
MR-JE-40A		
MR-JE-70A		
MR-JE-100A	FR-HAL-2.2K	B
MR-JE-200A		
MR-JE-300A		

Dimensions		[Unit: mm]	Connections																																																			
A		<table border="1"> <thead> <tr> <th rowspan="2">Model</th> <th colspan="7">Variable dimensions</th> </tr> <tr> <th>W</th> <th>W1</th> <th>H</th> <th>D (Note 3)</th> <th>D1</th> <th>D2</th> <th>d</th> </tr> </thead> <tbody> <tr> <td>FR-HAL-0.4K</td> <td>104 (Note 2)</td> <td>84</td> <td>99</td> <td>72</td> <td>51</td> <td>40</td> <td>M5</td> </tr> <tr> <td>FR-HAL-0.75K</td> <td>104 (Note 2)</td> <td>84</td> <td>99</td> <td>74</td> <td>56</td> <td>44</td> <td>M5</td> </tr> <tr> <td>FR-HAL-1.5K</td> <td>104 (Note 2)</td> <td>84</td> <td>99</td> <td>77</td> <td>61</td> <td>50</td> <td>M5</td> </tr> </tbody> </table> <table border="1"> <thead> <tr> <th>Model</th> <th>Mass [kg]</th> <th>Terminal screw size</th> </tr> </thead> <tbody> <tr> <td>FR-HAL-0.4K</td> <td>0.6</td> <td>M4</td> </tr> <tr> <td>FR-HAL-0.75K</td> <td>0.8</td> <td>M4</td> </tr> <tr> <td>FR-HAL-1.5K</td> <td>1.1</td> <td>M4</td> </tr> </tbody> </table>	Model	Variable dimensions							W	W1	H	D (Note 3)	D1	D2	d	FR-HAL-0.4K	104 (Note 2)	84	99	72	51	40	M5	FR-HAL-0.75K	104 (Note 2)	84	99	74	56	44	M5	FR-HAL-1.5K	104 (Note 2)	84	99	77	61	50	M5	Model	Mass [kg]	Terminal screw size	FR-HAL-0.4K	0.6	M4	FR-HAL-0.75K	0.8	M4	FR-HAL-1.5K	1.1	M4	<p>For 3-phase 200 V AC to 240 V AC</p>
				Model	Variable dimensions																																																	
W	W1	H	D (Note 3)		D1	D2	d																																															
FR-HAL-0.4K	104 (Note 2)	84	99	72	51	40	M5																																															
FR-HAL-0.75K	104 (Note 2)	84	99	74	56	44	M5																																															
FR-HAL-1.5K	104 (Note 2)	84	99	77	61	50	M5																																															
Model	Mass [kg]	Terminal screw size																																																				
FR-HAL-0.4K	0.6	M4																																																				
FR-HAL-0.75K	0.8	M4																																																				
FR-HAL-1.5K	1.1	M4																																																				
B		<table border="1"> <thead> <tr> <th rowspan="2">Model</th> <th colspan="7">Variable dimensions</th> </tr> <tr> <th>W</th> <th>W1</th> <th>H</th> <th>D (Note 3)</th> <th>D1</th> <th>D2</th> <th>d</th> </tr> </thead> <tbody> <tr> <td>FR-HAL-2.2K</td> <td>115 (Note 3)</td> <td>40</td> <td>115</td> <td>77</td> <td>71</td> <td>57</td> <td>M6</td> </tr> <tr> <td>FR-HAL-3.7K</td> <td>115 (Note 3)</td> <td>40</td> <td>115</td> <td>83</td> <td>81</td> <td>67</td> <td>M6</td> </tr> <tr> <td>FR-HAL-5.5K</td> <td>115 (Note 3)</td> <td>40</td> <td>115</td> <td>83</td> <td>81</td> <td>67</td> <td>M6</td> </tr> </tbody> </table> <table border="1"> <thead> <tr> <th>Model</th> <th>Mass [kg]</th> <th>Terminal screw size</th> </tr> </thead> <tbody> <tr> <td>FR-HAL-2.2K</td> <td>1.5</td> <td>M4</td> </tr> <tr> <td>FR-HAL-3.7K</td> <td>2.2</td> <td>M4</td> </tr> <tr> <td>FR-HAL-5.5K</td> <td>2.3</td> <td>M4</td> </tr> </tbody> </table>	Model	Variable dimensions							W	W1	H	D (Note 3)	D1	D2	d	FR-HAL-2.2K	115 (Note 3)	40	115	77	71	57	M6	FR-HAL-3.7K	115 (Note 3)	40	115	83	81	67	M6	FR-HAL-5.5K	115 (Note 3)	40	115	83	81	67	M6	Model	Mass [kg]	Terminal screw size	FR-HAL-2.2K	1.5	M4	FR-HAL-3.7K	2.2	M4	FR-HAL-5.5K	2.3	M4	<p>For 1-phase 200 V AC to 240 V AC</p>
				Model	Variable dimensions																																																	
W	W1	H	D (Note 3)		D1	D2	d																																															
FR-HAL-2.2K	115 (Note 3)	40	115	77	71	57	M6																																															
FR-HAL-3.7K	115 (Note 3)	40	115	83	81	67	M6																																															
FR-HAL-5.5K	115 (Note 3)	40	115	83	81	67	M6																																															
Model	Mass [kg]	Terminal screw size																																																				
FR-HAL-2.2K	1.5	M4																																																				
FR-HAL-3.7K	2.2	M4																																																				
FR-HAL-5.5K	2.3	M4																																																				

- Notes: 1. Use this mounting hole for grounding.  
 2.  $W \pm 2$  is applicable for FR-HAL-0.4K to 1.5K.  
 3. This indicates the maximum dimension. (The dimension varies depending on the bending degree of the Input/Output line.)

## Servo Support Software

### Capacity selection software (MRZJW3-MOTSZ111E)

#### Specifications

Item	Description
Types of machine component	Horizontal ball screws, vertical ball screws, rack and pinions, roll feeds, rotating tables, carts, elevators, conveyors, other (direct inertia input) devices
Output of results	Item
	Printing
	Data saving
Moment of inertia calculation function	Cylinder, square block, variable speed, linear movement, hanging, conical, conical base

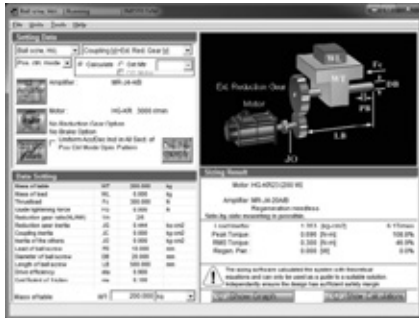

#### System requirements

IBM PC/AT compatible model running with the following requirements.

Components		Capacity selection software (MRZJW3-MOTSZ111E) (Note 1)
Personal computer (Note 2)	OS (Note 3)	Windows® 98, Windows® Me, Windows® 2000 Professional, Windows® XP Home Edition/Professional, Windows Vista® Home Basic/Home Premium/Business/Ultimate/Enterprise, Windows® 7 Starter/Home Premium/Professional/Ultimate/Enterprise
	CPU	Pentium® 133 MHz or more (Windows® 98, Windows® 2000 Professional) Pentium® 150 MHz or more (Windows® Me) Pentium® 300 MHz or more (Windows® XP Home Edition/Professional) 1 GHz or more 32-bit (x86) processor (Windows Vista® Home Basic/Home Premium/ Business/Ultimate/Enterprise) 1 GHz or more 32-bit (x86) or 64-bit (x64) processor (Windows® 7 Starter/Home Premium/Professional/ Ultimate/Enterprise)
	Memory	24 MB or more (Windows® 98) 32 MB or more (Windows® Me, Windows® 2000 Professional) 128 MB or more (Windows® XP Home Edition/Professional) 512 MB or more (Windows Vista® Home Basic) 1 GB or more (Windows Vista® Home Premium/Business/Ultimate/Enterprise, Windows® 7 Starter/Home Premium/Professional/Ultimate/Enterprise)
	Free hard disk space	40 MB or more
Communication interface		-
Browser		Windows® Internet Explorer® 4.0 or later
Monitor		Resolution 800 × 600 or more, 16-bit high color, Compatible with above personal computers.
Keyboard		Compatible with above personal computers.
Mouse		Compatible with above personal computers.
Printer		Compatible with above personal computers.
Communication cable		Not required

Notes: 1. Software version C6 or later will be compatible with MR-JE series.

2. This software may not run correctly, depending on a personal computer being used.

3. For 64-bit operating system, this software is compatible with Windows® 7.





## Servo Support Software MR Configurator2 (SW1DNC-MRC2-E)

MR Configurator2 can be obtained by either of the following:

- Purchase MR Configurator2 alone.
- Purchase MT Works2: MR Configurator2 is included in MT Works2 with software version 1.34L or later.
- Download MR Configurator2: If you have GX Works2 or MT Works2 with software version earlier than 1.34L, you can download MR Configurator2 from website free of charge.

### Specifications

Item	Description
Project	Create/read/save/delete project, system setting, print
Parameter	Parameter setting, axis name setting, parameter converter
Monitor	Display all, I/O monitor, graph
Diagnosis	Alarm display, alarm onset data, drive recorder, no motor rotation, system configuration, life diagnosis, machine diagnosis
Test mode	JOG mode, positioning mode, motor-less operation, DO forced output, program operation, test mode information
Adjustment	One-touch tuning, tuning, machine analyzer
Others	Servo assistant, parameter setting range update, help display

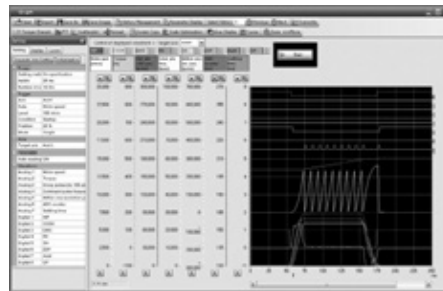
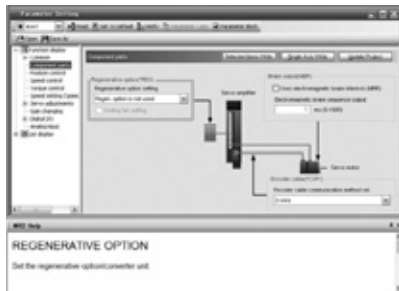

### System requirements

IBM PC/AT compatible model running with the following requirements.

Components		MR Configurator2 (Note 3)
Personal computer (Note 1)	OS (Note 2)	Windows® 2000 Professional, Windows® XP Home Edition/Professional, Windows Vista® Home Basic/Home Premium/Business/Ultimate/Enterprise, Windows® 7 Starter/Home Premium/Professional/Ultimate/Enterprise
	CPU (recommended)	Desktop PC: Intel® Celeron® processor 2.8 GHz or more Laptop PC: Intel® Pentium® M processor 1.7 GHz or more
	Memory (recommended)	512 MB or more (32-bit OS), 1 GB or more (64-bit OS)
	Free hard disk space	1 GB or more
	Communication interface	Use USB port
Browser		Windows® Internet Explorer® 4.0 or later
Monitor		Resolution 1024 x 768 or more, 16-bit high color, Compatible with above personal computers.
Keyboard		Compatible with above personal computers.
Mouse		Compatible with above personal computers.
Printer		Compatible with above personal computers.
Communication cable		MR-J3USBCBL3M

- Notes: 1. This software may not run correctly, depending on a personal computer being used.  
2. For 64-bit operating system, this software is compatible with Windows® 7.  
3. Software version 1.19V or later is compatible with MR-JE series.

MEMO

---

# 4

Features of Low-Voltage Switchgear.....	4-1
Wires, Molded-Case Circuit Breakers and Magnetic Contactors .....	4-4
Selection Example in HIV Wires for Servo Motors .....	4-4

## Low-Voltage Switchgear/Wires

## Mitsubishi Molded Case Circuit Breakers and Earth Leakage Circuit Breakers WS-V Series

"WS-V Series" is the new circuit breakers that have a lot of superior aspects such as higher breaking capacity, design for easy use, standardization of accessory parts, and compliance to the global standards.

### Features

**Technologies based on long years of experience are brought together to achieve improved performance**

The new circuit breaking technology "Expanded ISTAC" has improved the current-limiting performance and upgraded the overall breaking capacity. Expansion of the conductor under the stator shortens the contact parting time of the mover as compared to the conventional ISTAC structure. The current-limiting performance has been improved remarkably. (The maximum peak current value has been reduced by approx. 10%.)

### Compact design for ease of use

The thermal adjustable circuit breakers and electronic circuit breakers are smaller.

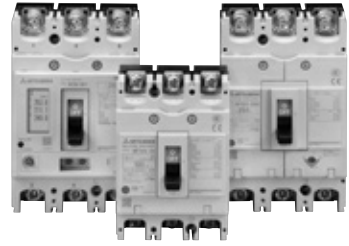

### New circuit breaking technology (Expanded ISTAC)

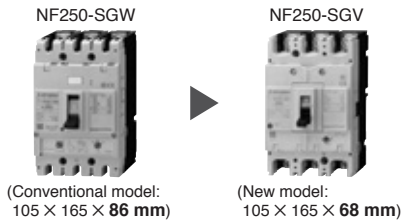
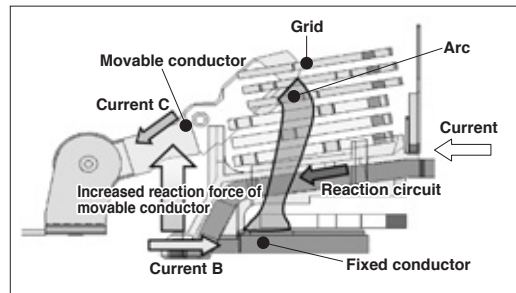

**Volume ratio 79%**  
(Compared with our conventional models)

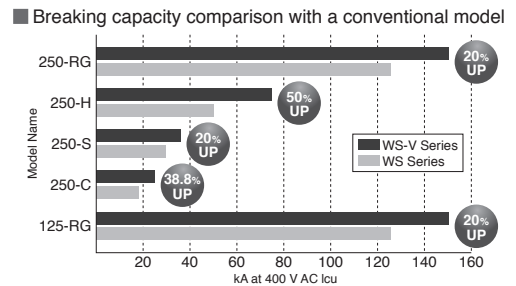

**Types of internal accessories are reduced from 3 types to 1 type**  
Standardization of internal accessories contributes to a reduction of stock and delivery time.

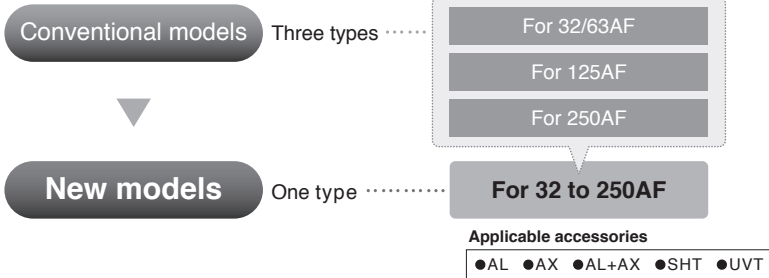

### Lineup of UL 489 listed circuit breakers with 54 mm width "Small Fit" (F) Style

The compact breakers contribute to a size reduction of machines, and IEC 35 mm rail mounting is standard.

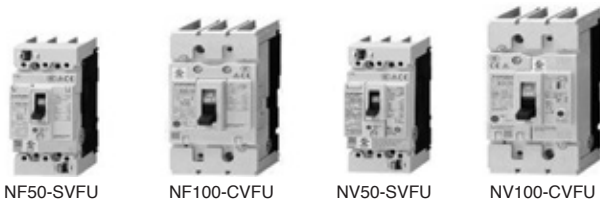

For security and standard compliance of machines, F-type and V-type operating handles are available for breakers with 54 mm width.

### Lineup of UL 489 listed circuit breakers for 480 V AC "High Performance"

The breaking capacity has been improved to satisfy the request for SCCR upgrading.

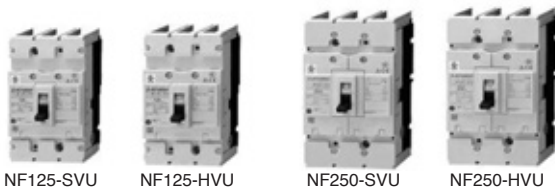

Breaking capacity of UL 489 listed circuit breakers for 480 V AC (UL 489)

- NF125-SVU/NV125-SVU: 30 kA
- NF125-HVU/NV125-HVU: 50 kA
- NF250-SVU/NV250-SVU: 35 kA
- NF250-HVU/NV250-HVU: 50 kA



## Mitsubishi Magnetic Motor Starters and Magnetic Contactors MS-T Series

MS-T series is newly released!

The MS-T series is smaller than ever, enabling more compact control panel. The MS-T series is suitable for MELSERVO-JE series as well as other Mitsubishi FA equipment. In addition, the MS-T conforms to a variety of global standards, supporting the global use.

### Features

#### Compact

**Just 36 mm wide for 10 A-frame type!**

General-purpose magnetic contactor with smallest width\* in the industry.

The width of MS-T series is reduced by 32% as compared to the prior MS-N series, enabling a more compact panel.

\*Based on Mitsubishi Electric research as of September 2012 in the general-purpose magnetic contactor industry for 10 A-frame class.



S-T10

[Unit: mm]

Frame size		11 A	13 A		20 A	25 A
MS-N series	Front view					
		S-N10	S-N11 (Auxiliary 1-pole)	S-N12 (Auxiliary 2-pole)	S-N20	S-N25
New MS-T series	Front view					
		S-T10	S-T12 (Auxiliary 2-pole)	S-T20	S-T25	

### Standardization

#### Covers provided as standard equipment

Terminal cover and auxiliary contact unit covers are provided as standard equipment. Not only ensuring your safety, but also saving you time and cost of selecting and purchasing the covers separately.

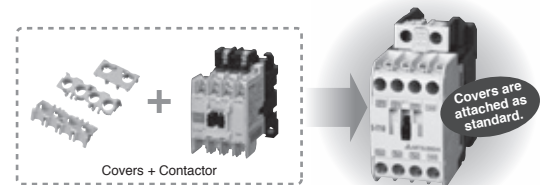

#### Wide-ranged operation coil rating

The prior series had 14 types of the operation coil rating. Owing to the wide-ranged operation coil rating, the number of the rating types for the MS-T series is reduced to half, making it easier to select as compared to the prior model.

Consolidating the number of the produced coils type allows not just the reduction of customer storage, but also shortening of delivery time.

Coil designation	Rated voltage [V]		Coil designation	Rated voltage [V]	
	50 Hz	60 Hz		50 Hz/60 Hz	
AC12 V	12	12	AC24 V	24	
AC24 V	24	24	AC48 V	48 to 50	
AC48 V	48 to 50	48 to 50	AC100 V	100 to 127	
AC100 V	100	100 to 110	AC200 V	200 to 240	
AC120 V	110 to 120	115 to 120	AC300 V	260 to 300	
AC127 V	125 to 127	127	AC400 V	380 to 440	
AC200 V	200	200 to 220	AC500 V	460 to 550	
AC220 V	208 to 220	220			
AC230 V	220 to 240	230 to 240			
AC260 V	240 to 260	260 to 280			
AC380 V	346 to 380	380			
AC400 V	380 to 415	400 to 440			
AC440 V	415 to 440	460 to 480			
AC500 V	500	500 to 550			

\* 12 V type is an order-made product.

### Global Standard

#### Conforms to various global standards

Not only major global standards such as IEC, JIS, UL, CE, and CCC but also ship standards and other country standards are planned to be certified.

⊙: Compliant as standard

Model	Applicable Standard				Safety Standard		EC Directive	Certification Body	CCC
	IEC	JIS	DIN/VDE	BS/EN	UL	CSA	CE Marking	TÜV	GB
	International	Japan	Germany	England Europe	U.S.A	Canada	Europe	Germany	China
S-T10 to S-T32 MSO-T10 to MSO-T25 TH-T18(KP) to TH-T25(KP)	⊙	⊙	⊙	⊙	⊙	⊙	⊙	⊙ <sup>1,2</sup>	⊙ <sup>1</sup>

<sup>1</sup>1. CCC and TÜV approval will be obtained soon.

<sup>2</sup>2. The Motor Starters will be certified under each type name of the Magnetic contactors and the Thermal Overload Relays on the condition that the Magnetic contactors and the Thermal Overload Relays are used in combination.

## Mitsubishi Magnetic Motor Starters and Magnetic Contactors MS-N Series

Environment-friendly Mitsubishi MS-N series ensures safety and conforms to various global standards. Its compact size contributes to space-saving in a machine. The MS-N series is suitable for MELSERVO-JE series as well as other Mitsubishi FA equipment and can be used globally.

### Features

#### Bifurcated contact adopted to achieve high contact reliability

Contact reliability is greatly improved by combining bifurcated moving contact and stationary contact. This series responds to the various needs such as the application to safety circuit.

\* The MS-T series also has bifurcated contacts.

#### Mirror contact (auxiliary contact off at main contact welding)

The MS-N series meets requirements of "Control functions in the event of failure" described in EN 60204-1 "Electrical equipment of machines", being suitable as interlock circuit contact. The MS-N series is applicable for category 4 safety circuit. We ensure safety for our customers.

\* The MS-T series also has mirror contacts.

#### Various option units

Various options including surge absorbers and additional auxiliary contact blocks are available.

#### Conforms to various global standards



S-N35CX

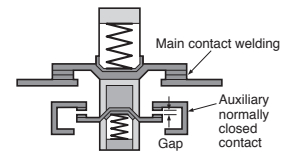

⊙ : Compliant as standard

Model	Applicable Standard				Safety Standard		EC Directive	Certification Body	CCC
	IEC	JIS	DIN/VE	BS/EN	UL	CSA	CE Marking	TÜV	GB
	International	Japan	Germany	England Europe	U.S.A	Canada	Europe	Germany	China
S-N10 to S-N400 MSO-N10 to MSO-N400 TH-N12KP to TH-N400KP	⊙	⊙	⊙	⊙	⊙	⊙	⊙	⊙ *1	⊙

\*1. The Motor Starters are certified under each type name of the Magnetic contactors and the Thermal Overload Relays on the condition that the Magnetic contactors and the Thermal Overload Relays are used in combination.



## Wires, Molded-Case Circuit Breakers and Magnetic Contactors

The following are examples of wire sizes when 600 V grade heat-resistant polyvinyl chloride insulated wires (HIV wires) are used. The wire size for U, V, W, and  $\ominus$  varies depending on the servo motor. Refer to "Selection Example in HIV Wires for Servo Motors" in this catalog for details on wires for each servo motor.

Servo amplifier model	Molded-case circuit breaker (Note 4)	Magnetic contactor (Note 2)	Wire size [mm <sup>2</sup> ]		
			L1, L2, L3, $\ominus$	P+, C	U, V, W, $\ominus$
MR-JE-10A	30 A frame 5 A	S-N10 S-T10	2 (AWG 14) (Note 1)	2 (AWG 14) (Note 1)	AWG 18 to 14 (Note 3)
MR-JE-20A	30 A frame 5 A	S-N10 S-T10			
MR-JE-40A	30 A frame 10 A	S-N10 S-T10			
MR-JE-70A	30 A frame 15 A	S-N10 S-T10			
MR-JE-100A	30 A frame 15 A	S-N10 S-T10			
MR-JE-200A	30 A frame 20 A	S-N20 (Note 5) S-T21			3.5 (AWG 12)
MR-JE-300A	30 A frame 30 A	S-N20 S-T21			

- Notes: 1. Keep the wire length to the regenerative option within 5 m.  
 2. Be sure to use a magnetic contactor with an operation delay time of 80 ms or less. The operation delay time is the time interval from current being applied to the coil until closure of contacts.  
 3. The wire size shows applicable size for the servo amplifier connector.  
 4. When complying with UL/CSA standard, refer to "MELSERVO-JE Instructions and Cautions for Safe Use of AC Servos" enclosed with the servo amplifier.  
 5. S-N18 can be used when auxiliary contact is not required.

## Selection Example in HIV Wires for Servo Motors

The following are examples of wire sizes when 600 V grade heat-resistant polyvinyl chloride insulated wires (HIV wires) with a length of 30 m are used. Refer to "HF-KN HF-SN Servo Motor Instruction Manual" when using cab-tire cables for supplying power (U, V, and W) to HF-SN series.

Servo motor	Wire size [mm <sup>2</sup> ]	
	For power and grounding (U, V, W, $\ominus$ ) (general environment)	For electromagnetic brake (B1, B2)
HF-KN13(B)J, 23(B)J, 43(B)J, 73(B)J	0.75 (AWG 18) (Note 1, 2, 3)	0.5 (AWG 20) (Note 4)
HF-SN52(B)J, 102(B)J	1.25 (AWG 16) (Note 5)	1.25 (AWG 16)
HF-SN152(B)J, 202(B)J	2 (AWG 14)	
HF-SN302(B)J	3.5 (AWG 12)	

- Notes: 1. Use a fluorine resin wire of 0.75 mm<sup>2</sup> (AWG 18) for wiring to the servo motor power connector.  
 2. This size is applicable for wiring length of 10 m or shorter. For over 10 m, use MR-PWS2CBL03M-A\_-L and extend it with HIV wire of 1.25 mm<sup>2</sup> (AWG 16).  
 3. When complying with UL/CSA standard, extend the wire using MR-PWS2CBL03M-A\_-L and HIV wire of 2 mm<sup>2</sup> (AWG 14).  
 4. Use a fluorine resin wire of 0.5 mm<sup>2</sup> (AWG 20) when connecting to servo motor electromagnetic brake connector.  
 5. When complying with UL/CSA standard, use 2 mm<sup>2</sup> (AWG 14). Refer to "HF-KN HF-SN Servo Motor Instruction Manual" for details.

## Servo amplifiers

Item	Model	Rated output	Power supply
MR-JE-A	MR-JE-10A	0.1 kW	3-phase or 1-phase 200 V AC to 240 V AC
	MR-JE-20A	0.2 kW	3-phase or 1-phase 200 V AC to 240 V AC
	MR-JE-40A	0.4 kW	3-phase or 1-phase 200 V AC to 240 V AC
	MR-JE-70A	0.75 kW	3-phase or 1-phase 200 V AC to 240 V AC
	MR-JE-100A	1 kW	3-phase 200 V AC to 240 V AC
	MR-JE-200A	2 kW	3-phase 200 V AC to 240 V AC
	MR-JE-300A	3 kW	3-phase 200 V AC to 240 V AC

## Servo motors

Item	Model	Rated output	Rated speed
HF-KN series Without electromagnetic brake With oil seal	HF-KN13J	100 W	3000 r/min
	HF-KN23J	200 W	3000 r/min
	HF-KN43J	400 W	3000 r/min
	HF-KN73J	750 W	3000 r/min
HF-KN series Without electromagnetic brake Without oil seal	HF-KN13	100 W	3000 r/min
	HF-KN23	200 W	3000 r/min
	HF-KN43	400 W	3000 r/min
HF-KN series With electromagnetic brake With oil seal	HF-KN13BJ	100 W	3000 r/min
	HF-KN23BJ	200 W	3000 r/min
	HF-KN43BJ	400 W	3000 r/min
	HF-KN73BJ	750 W	3000 r/min
HF-KN series With electromagnetic brake Without oil seal	HF-KN13B	100 W	3000 r/min
	HF-KN23B	200 W	3000 r/min
	HF-KN43B	400 W	3000 r/min
HF-SN series Without electromagnetic brake With oil seal	HF-SN52J	0.5 kW	2000 r/min
	HF-SN102J	1.0 kW	2000 r/min
	HF-SN152J	1.5 kW	2000 r/min
	HF-SN202J	2.0 kW	2000 r/min
	HF-SN302J	3.0 kW	2000 r/min
HF-SN series With electromagnetic brake With oil seal	HF-SN52BJ	0.5 kW	2000 r/min
	HF-SN102BJ	1.0 kW	2000 r/min
	HF-SN152BJ	1.5 kW	2000 r/min
	HF-SN202BJ	2.0 kW	2000 r/min
	HF-SN302BJ	3.0 kW	2000 r/min



## Encoder cables/Junction cables

Item	Model	Length	Bending life	IP rating	Application
Encoder cable (load-side lead)	MR-J3ENCBL2M-A1-H	2 m	Long bending life	IP65	For HF-KN (direct connection type)
	MR-J3ENCBL5M-A1-H	5 m	Long bending life	IP65	For HF-KN (direct connection type)
	MR-J3ENCBL10M-A1-H	10 m	Long bending life	IP65	For HF-KN (direct connection type)
	MR-J3ENCBL2M-A1-L	2 m	Standard	IP65	For HF-KN (direct connection type)
	MR-J3ENCBL5M-A1-L	5 m	Standard	IP65	For HF-KN (direct connection type)
	MR-J3ENCBL10M-A1-L	10 m	Standard	IP65	For HF-KN (direct connection type)
Encoder cable (opposite to load-side lead)	MR-J3ENCBL2M-A2-H	2 m	Long bending life	IP65	For HF-KN (direct connection type)
	MR-J3ENCBL5M-A2-H	5 m	Long bending life	IP65	For HF-KN (direct connection type)
	MR-J3ENCBL10M-A2-H	10 m	Long bending life	IP65	For HF-KN (direct connection type)
	MR-J3ENCBL2M-A2-L	2 m	Standard	IP65	For HF-KN (direct connection type)
	MR-J3ENCBL5M-A2-L	5 m	Standard	IP65	For HF-KN (direct connection type)
	MR-J3ENCBL10M-A2-L	10 m	Standard	IP65	For HF-KN (direct connection type)
Encoder cable (load-side lead)	MR-J3JCBL03M-A1-L	0.3 m	Standard	IP20	For HF-KN (junction type) <sup>(Note 1)</sup>
Encoder cable (opposite to load-side lead)	MR-J3JCBL03M-A2-L	0.3 m	Standard	IP20	For HF-KN (junction type) <sup>(Note 1)</sup>
Encoder cable	MR-EKCB20M-H	20 m	Long bending life	IP20	For HF-KN (junction type) <sup>(Note 2)</sup>
	MR-EKCB30M-H	30 m	Long bending life	IP20	For HF-KN (junction type) <sup>(Note 2)</sup>
	MR-EKCB40M-H	40 m	Long bending life	IP20	For HF-KN (junction type) <sup>(Note 2)</sup>
	MR-EKCB50M-H	50 m	Long bending life	IP20	For HF-KN (junction type) <sup>(Note 2)</sup>
	MR-EKCB20M-L	20 m	Standard	IP20	For HF-KN (junction type) <sup>(Note 2)</sup>
	MR-EKCB30M-L	30 m	Standard	IP20	For HF-KN (junction type) <sup>(Note 2)</sup>
Encoder cable (load-side lead)	MR-J3JSCBL03M-A1-L	0.3 m	Standard	IP65	For HF-KN (junction type) <sup>(Note 3)</sup>
Encoder cable (opposite to load-side lead)	MR-J3JSCBL03M-A2-L	0.3 m	Standard	IP65	For HF-KN (junction type) <sup>(Note 3)</sup>
Encoder cable	MR-J3ENSCBL2M-H	2 m	Long bending life	IP67	For HF-KN (junction type) <sup>(Note 4)</sup> , For HF-SN (direct connection type)
	MR-J3ENSCBL5M-H	5 m	Long bending life	IP67	
	MR-J3ENSCBL10M-H	10 m	Long bending life	IP67	
	MR-J3ENSCBL20M-H	20 m	Long bending life	IP67	
	MR-J3ENSCBL30M-H	30 m	Long bending life	IP67	
	MR-J3ENSCBL40M-H	40 m	Long bending life	IP67	
	MR-J3ENSCBL50M-H	50 m	Long bending life	IP67	
	MR-J3ENSCBL2M-L	2 m	Standard	IP67	For HF-KN (junction type) <sup>(Note 4)</sup> , For HF-SN (direct connection type)
	MR-J3ENSCBL5M-L	5 m	Standard	IP67	
	MR-J3ENSCBL10M-L	10 m	Standard	IP67	
	MR-J3ENSCBL20M-L	20 m	Standard	IP67	
	MR-J3ENSCBL30M-L	30 m	Standard	IP67	

## Encoder connector sets/Junction connector sets

Item	Model	Description	IP rating	Application
Encoder connector set	MR-ECNM	Junction connector × 1, Servo amplifier connector × 1	IP20	For HF-KN (junction type) <sup>(Note 2)</sup>
Encoder connector set (one-touch connection type)	MR-J3SCNS	Straight type Junction connector or encoder connector × 1, Servo amplifier connector × 1	IP67	For HF-KN (junction type) <sup>(Note 4)</sup> , For HF-SN (direct connection type)
Encoder connector set (one-touch connection type)	MR-J3SCNSA	Angle type Encoder connector × 1, Servo amplifier connector × 1	IP67	For HF-SN

### Notes:

1. Use this in combination with MR-EKCBL\_M-H, MR-EKCBL\_M-L, or MR-ECNM.
2. Use this in combination with MR-J3JCBL03M-A1-L or MR-J3JCBL03M-A2-L.
3. Use this in combination with MR-J3ENSCBL\_M-H, MR-J3ENSCBL\_M-L, or MR-J3SCNS.
4. Use this in combination with MR-J3JSCBL03M-A1-L or MR-J3JSCBL03M-A2-L when using for HF-KN series.

## Servo motor power cables

Item	Model	Length	Bending life	IP rating	Application
Servo motor power cable (load-side lead, lead-out)	MR-PWS1CBL2M-A1-H	2 m	Long bending life	IP65	For HF-KN (direct connection type)
	MR-PWS1CBL5M-A1-H	5 m	Long bending life	IP65	For HF-KN (direct connection type)
	MR-PWS1CBL10M-A1-H	10 m	Long bending life	IP65	For HF-KN (direct connection type)
	MR-PWS1CBL2M-A1-L	2 m	Standard	IP65	For HF-KN (direct connection type)
	MR-PWS1CBL5M-A1-L	5 m	Standard	IP65	For HF-KN (direct connection type)
	MR-PWS1CBL10M-A1-L	10 m	Standard	IP65	For HF-KN (direct connection type)
Servo motor power cable (opposite to load-side lead, lead-out)	MR-PWS1CBL2M-A2-H	2 m	Long bending life	IP65	For HF-KN (direct connection type)
	MR-PWS1CBL5M-A2-H	5 m	Long bending life	IP65	For HF-KN (direct connection type)
	MR-PWS1CBL10M-A2-H	10 m	Long bending life	IP65	For HF-KN (direct connection type)
	MR-PWS1CBL2M-A2-L	2 m	Standard	IP65	For HF-KN (direct connection type)
	MR-PWS1CBL5M-A2-L	5 m	Standard	IP65	For HF-KN (direct connection type)
	MR-PWS1CBL10M-A2-L	10 m	Standard	IP65	For HF-KN (direct connection type)
Servo motor power cable (load-side lead, lead-out)	MR-PWS2CBL03M-A1-L	0.3 m	Standard	IP55	For HF-KN (junction type)
Servo motor power cable (opposite to load-side lead, lead-out)	MR-PWS2CBL03M-A2-L	0.3 m	Standard	IP55	For HF-KN (junction type)

## Servo motor power connector sets

Item	Model	Description	IP rating	Application
Servo motor power connector set EN compliant	MR-PWCNS4	Straight type Power connector × 1	IP67	For HF-SN52J, 102J, 152J
	MR-PWCNS5	Straight type Power connector × 1	IP67	For HF-SN202J, 302J

## Electromagnetic brake cables

Item	Model	Length	Bending life	IP rating	Application
Electromagnetic brake cable (load-side lead, lead-out)	MR-BKS1CBL2M-A1-H	2 m	Long bending life	IP65	For HF-KN (direct connection type)
	MR-BKS1CBL5M-A1-H	5 m	Long bending life	IP65	For HF-KN (direct connection type)
	MR-BKS1CBL10M-A1-H	10 m	Long bending life	IP65	For HF-KN (direct connection type)
	MR-BKS1CBL2M-A1-L	2 m	Standard	IP65	For HF-KN (direct connection type)
	MR-BKS1CBL5M-A1-L	5 m	Standard	IP65	For HF-KN (direct connection type)
	MR-BKS1CBL10M-A1-L	10 m	Standard	IP65	For HF-KN (direct connection type)
Electromagnetic brake cable (opposite to load-side lead, lead-out)	MR-BKS1CBL2M-A2-H	2 m	Long bending life	IP65	For HF-KN (direct connection type)
	MR-BKS1CBL5M-A2-H	5 m	Long bending life	IP65	For HF-KN (direct connection type)
	MR-BKS1CBL10M-A2-H	10 m	Long bending life	IP65	For HF-KN (direct connection type)
	MR-BKS1CBL2M-A2-L	2 m	Standard	IP65	For HF-KN (direct connection type)
	MR-BKS1CBL5M-A2-L	5 m	Standard	IP65	For HF-KN (direct connection type)
	MR-BKS1CBL10M-A2-L	10 m	Standard	IP65	For HF-KN (direct connection type)
Electromagnetic brake cable (load-side lead, lead-out)	MR-BKS2CBL03M-A1-L	0.3 m	Standard	IP55	For HF-KN (junction type)
Electromagnetic brake cable (opposite to load-side lead, lead-out)	MR-BKS2CBL03M-A2-L	0.3 m	Standard	IP55	For HF-KN (junction type)

## Electromagnetic brake connector sets

Item	Model	Description	IP rating	Application
Electromagnetic brake connector set (one-touch connection type)	MR-BKCNS1	Straight type, Electromagnetic brake connector × 1	IP67	For HF-SN
Electromagnetic brake connector set (one-touch connection type)	MR-BKCNS1A	Angle type, Electromagnetic brake connector × 1	IP67	For HF-SN

## Junction terminal blocks/Junction terminal block cables

Item	Model	Length	Application
Junction terminal block (50 pins)	MR-TB50	-	For MR-JE-A
Junction terminal block cable (for MR-TB50)	MR-J2M-CN1TBL05M	0.5 m	For connecting MR-JE-A and MR-TB50
	MR-J2M-CN1TBL1M	1 m	For connecting MR-JE-A and MR-TB50

## Regenerative Options

Item	Model	Specifications	Application
Regenerative option	MR-RB032	Tolerable regenerative power: 30 W, resistance value: 40 Ω	For MR-JE-10A to MR-JE-100A
	MR-RB12	Tolerable regenerative power: 100 W, resistance value: 40 Ω	For MR-JE-20A to MR-JE-100A
	MR-RB30	Tolerable regenerative power: 300 W, resistance value: 13 Ω	For MR-JE-200A and MR-JE-300A
	MR-RB32	Tolerable regenerative power: 300 W, resistance value: 40 Ω	For MR-JE-70A and MR-JE-100A
	MR-RB50	Tolerable regenerative power: 500 W, resistance value: 13 Ω	For MR-JE-200A and MR-JE-300A

## Peripheral cables

Item	Model	Length	Application
Personal computer communication cable (USB cable)	MR-J3USBCBL3M	3 m	For MR-JE-A

## Peripheral connectors

Item	Model	Description	Application
Servo amplifier CNP1 power connector <sup>(Note 1)</sup> (insertion type)	MR-JECNP1-01	CNP1 connector × 1, Open tool × 1	For MR-JE-10A to MR-JE-100A
Servo amplifier CNP1 power connector <sup>(Note 1)</sup> (insertion type)	MR-JECNP1-02	CNP1 connector × 1, Open tool × 1	For MR-JE-200A and MR-JE-300A
Servo amplifier CNP2 power connector <sup>(Note 1)</sup> (insertion type)	MR-JECNP2-02	CNP2 connector × 1	For MR-JE-200A and MR-JE-300A
Connector set	MR-J3CN1	Servo amplifier connector × 1	For I/O signals of MR-JE-A

## Servo Support Software

Item	Model	Application
MR Configurator2	SW1DNC-MRC2-E	Servo setup software for AC servo

Notes:

1. CNP1 and CNP2 connectors, and open tool are supplied with the servo amplifier.

## To ensure safe use

- To use the products given in this catalog properly, always read the "Installation Guide" and "Instruction Manual" before starting to use them.

## Cautions for model selection

- Select a servo motor which has the rated torque equal to or higher than the continuous effective torque.
- When unbalanced torque is generated, such as in a vertical lift machine, it is recommended that the unbalanced torque of the machine be kept under 70% of the servo motor rated torque.
- Create the operating pattern by considering the settling time (ts).
- Load to motor inertia ratio must be below the recommended ratio. If the ratio is too large, the expected performance may not be achieved, and the dynamic brake may be damaged.

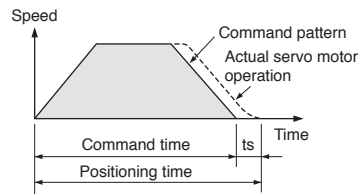

## General safety precautions

### 1. Transportation/installation

- Combinations of the servo motor and the servo amplifier are predetermined. Confirm the models of the servo motor and the servo amplifier to be used before installation.
- Do not drop or apply strong impact on the servo amplifier and the servo motor as they are precision devices. They may be damaged from such stress or shock.
- When you disinfect or protect wooden packing from insects, take measures except by fumigation. Fumigating the servo amplifier or packing the servo amplifier with fumigated wooden packing can cause a malfunction of the servo amplifier due to halogen materials (such as fluorine, chlorine, bromine, and iodine) which are contained in fumigant.
- Do not get on or place heavy objects on the servo amplifier or the servo motor. Doing so may result in injury or damage.
- The system must withstand high speeds and high acceleration/ deceleration.
- To enable high-accuracy positioning, ensure the machine rigidity, and keep the machine resonance point at a high level.
- Mount the servo amplifier and the servo motor on nonflammable material. Mounting them directly on or near flammable material may result in fires.
- The regenerative option becomes hot (the temperature rise of 100 °C or higher) with frequent use. Do not install within flammable objects or objects subject to thermal deformation. Make sure that wires do not come into contact with the unit.
- Securely fix the servo motor onto the machine. Insufficient fixing may cause the servo motor to dislocate during operation.
- Install electrical and mechanical stoppers at the stroke end.
- Mount the servo amplifier vertically on a wall.
- Do not block intake and exhaust areas of the servo amplifier. Doing so may cause the servo amplifier to malfunction.
- When installing multiple servo amplifiers in a row in a sealed cabinet, leave space around the servo amplifiers as described in Servo Amplifier Instruction Manual. To ensure the life and reliability of the servo amplifiers, prevent heat accumulation by keeping space as open as possible toward the top plate.

### 2. Environment

- Use the servo amplifier and the servo motor in the designated environment.
- Avoid installing the servo amplifier and the servo motor in areas with oil mist or dust. When installing in such areas, be sure to enclose the servo

amplifier in a sealed cabinet, and protect the servo motor by furnishing a cover or by taking similar measures.

- Do not use in areas where the servo motor may be constantly subject to cutting fluid or lubricant oil, or where dew could condense because of oil mist, overcooling or excessive humidity. Doing so may deteriorate the insulation of the servo motor.
- The servo amplifier must not be used with parts which contain halogen-series flame retardant materials (such as bromine) under coexisting conditions.

### 3. Grounding

- Securely ground to prevent electric shocks and to stabilize the potential in the control circuit.
- Connect the grounding wire to the cabinet protective earth (PE) terminal via the servo amplifier protective earth (PE) terminal for the servo motor grounding.
- Faults such as a position mismatch may occur if the grounding is insufficient.

### 4. Wiring

- Do not supply power to the output terminals (U, V, and W) of the servo amplifier or the input terminals (U, V, and W) of the servo motor. Doing so damages the servo amplifier and the servo motor.
- Connect the servo motor to the output terminals (U, V, and W) of the servo amplifier.
- Match the phase of the input terminals (U, V, and W) of the servo motor to the output terminals (U, V, and W) of the servo amplifier when connecting them. If they do not match, the servo motor does not operate properly.
- Check the wiring and sequence program thoroughly before switching the power on.
- Carefully select the cable clamping method, and make sure that bending stress and the stress of the cable's own weight are not applied on the cable connection section.
- In an application where the servo motor moves, determine the cable bending radius according to the cable bending life and wire type.

### 5. Factory settings

- Select a control mode from position, speed or torque by [Pr. PA01]. Position control mode is set as default. Change the parameter setting value when using the other control modes.
- When using the regenerative option, change [Pr. PA02]. The regenerative option is disabled as default.

### 6. Operation

- Do not use a product which is damaged or has missing parts. In that case, replace the product.
- Turn on FLS and RLS (Upper/Lower stroke limit), or LSP and LSN (Forward/Reverse rotation stroke end) in position or speed control mode. The servo motor will not start if the signals are off.
- When a magnetic contactor is installed on the primary side of the servo amplifier, do not perform frequent starts and stops with the magnetic contactor. Doing so may damage the servo amplifier.
- When an error occurs, the servo amplifier stops outputting the power with activation of the protective function, and the servo motor stops immediately with the dynamic brake.
- The dynamic brake is a function for emergency stop. Do not use it to stop the servo motor in normal operations.
- As a rough guide, the dynamic brake withstands 1000 times of use when a machine which has load to motor inertia ratio equals to or lower than the recommended ratio stops from the rated speed every 10 minutes.
- If the protective functions of the servo amplifier activate, turn the power off immediately. Remove the cause before turning the power on again. If operation is continued without removing the cause of the error, the servo motor may malfunction, resulting in injury or damage.



- The servo amplifier, the regenerative resistor, and the servo motor can be very hot during or after operation. Take safety measures such as covering them to prevent your hand and/or parts including cables from coming in contact with them.

#### 7. Others

- Do not touch the servo amplifier or the servo motor with wet hands.
- Do not modify the servo amplifier or the servo motor.

### Cautions for servo motors

- Do not hammer the shaft of the servo motor when installing a pulley or a coupling. Doing so may damage the encoder. When installing the pulley or the coupling to the key shaft servo motor, use the screw hole on the shaft end. Use a pulley extractor when removing the pulley.
- Do not apply a load exceeding the tolerable load onto the servo motor shaft. The shaft may break.
- When the servo motor is mounted with the shaft vertical (shaft up), take measures on the machine side so that oil from the gear box does not get into the servo motor.
- Do not use the 24 V DC interface power supply for the electromagnetic brake. Provide a dedicated power supply to the electromagnetic brake.
- Do not apply the electromagnetic brake when the servo is on. Doing so may cause the servo amplifier overload or shorten the brake life. Apply the electromagnetic brake when the servo is off.
- Torque may drop due to temperature increase of the servo motor. Be sure to use the motor within the specified ambient temperature.

## Warranty

### 1. Warranty period and coverage

We will repair any failure or defect hereinafter referred to as "failure" in our FA equipment hereinafter referred to as the "Product" arisen during warranty period at no charge due to causes for which we are responsible through the distributor from which you purchased the Product or our service provider. However, we will charge the actual cost of dispatching our engineer for an on-site repair work on request by customer in Japan or overseas countries. We are not responsible for any on-site readjustment and/or trial run that may be required after a defective unit is repaired or replaced.

#### [Term]

The term of warranty for Product is twelve (12) months after your purchase or delivery of the Product to a place designated by you or eighteen (18) months from the date of manufacture whichever comes first ("Warranty Period"). Warranty period for repaired Product cannot exceed beyond the original warranty period before any repair work.

#### [Limitations]

- (1) You are requested to conduct an initial failure diagnosis by yourself, as a general rule. It can also be carried out by us or our service company upon your request and the actual cost will be charged. However, it will not be charged if we are responsible for the cause of the failure.
- (2) This limited warranty applies only when the condition, method, environment, etc. of use are in compliance with the terms and conditions and instructions that are set forth in the instruction manual and user manual for the Product and the caution label affixed to the Product.
- (3) Even during the term of warranty, the repair cost will be charged on you in the following cases;
  - (i) a failure caused by your improper storing or handling, carelessness or negligence, etc., and a failure caused by your hardware or software problem
  - (ii) a failure caused by any alteration, etc. to the Product made on your side without our approval
  - (iii) a failure which may be regarded as avoidable, if your equipment in which the Product is incorporated is equipped with a safety device required by applicable laws and has any function or structure considered to be indispensable according to a common sense in the industry
  - (iv) a failure which may be regarded as avoidable if consumable parts designated in the instruction manual, etc. are duly maintained and replaced
  - (v) any replacement of consumable parts (battery, fan, smoothing capacitor, etc.)
  - (vi) a failure caused by external factors such as inevitable accidents, including without limitation fire and abnormal fluctuation of voltage, and acts of God, including without limitation earthquake, lightning and natural disasters
  - (vii) a failure generated by an unforeseeable cause with a scientific technology that was not available at the time of the shipment of the Product from our company
  - (viii) any other failures which we are not responsible for or which you acknowledge we are not responsible for

### 2. Term of warranty after the stop of production

- (1) We may accept the repair at charge for another seven (7) years after the production of the product is discontinued. The announcement of the stop of production for each model can be seen in our Sales and Service, etc.
- (2) Please note that the Product (including its spare parts) cannot be ordered after its stop of production.

### 3. Service in overseas countries

Our regional FA Center in overseas countries will accept the repair work of the Product. However, the terms and conditions of the repair work may differ depending on each FA Center. Please ask your local FA Center for details.

### 4. Exclusion of responsibility for compensation against loss of opportunity, secondary loss, etc.

Whether under or after the term of warranty, we assume no responsibility for any damages arisen from causes for which we are not responsible, any losses of opportunity and/or profit incurred by you due to a failure of the Product, any damages, secondary damages or compensation for accidents arisen under a specific circumstance that are foreseen or unforeseen by our company, any damages to products other than the Product, and also compensation for any replacement work, readjustment, start-up test run of local machines and the Product and any other operations conducted by you.

### 5. Change of Product specifications

Specifications listed in our catalogs, manuals or technical documents may be changed without notice.

### 6. Application and use of the Product

- (1) For the use of our General-Purpose AC Servo, its applications should be those that may not result in a serious damage even if any failure or malfunction occurs in General-Purpose AC Servo, and a backup or fail-safe function should operate on an external system to General-Purpose AC Servo when any failure or malfunction occurs.
- (2) Our General-Purpose AC Servo is designed and manufactured as a general purpose product for use at general industries. Therefore, applications substantially influential on the public interest for such as atomic power plants and other power plants of electric power companies, and also which require a special quality assurance system, including applications for railway companies and government or public offices are not recommended, and we assume no responsibility for any failure caused by these applications when used.

In addition, applications which may be substantially influential to human lives or properties for such as airlines, medical treatments, railway service, incineration and fuel systems, man-operated material handling equipment, entertainment machines, safety machines, etc. are not recommended, and we assume no responsibility for any failure caused by these applications when used.

We will review the acceptability of the abovementioned applications, if you agree not to require a specific quality for a specific application. Please contact us for consultation.



**MEMO**

Servo Amplifiers

Servo Motors

Options/Peripheral  
Equipment

LVSWires

Product List

**Cautions**

# FA Products

PLC

MELSEC-Q Series Universal Model



Introducing the high-speed QCPU (QnUDVCPU) for faster processing of large data volumes.

- ◎Realize high-speed, high-accuracy machine control with various iQ Platform compatible controllers and multiple CPUs.
- ◎Easily connect to GOTs and Programming tools using built-in Ethernet port.
- ◎25 models from 10 k step small capacity to 1000 k step large capacity, are available.
- ◎Seamless communication and flexible integration at any network level.

Product Specifications

Program capacity	10k steps to 1000k steps
Number of I/O points [X/Y], number of I/O device points [X/Y]	256 points to 4096 points/8192 points
Basic instruction processing speed (LD instruction)	120ns to 1.9ns
External connection interface	USB (all models equipped), Ethernet, RS-232, memory card, extended SRAM cassette
Function module	I/O, analog, high-speed counter, positioning, simple motion, temperature input, temperature control, network module
Module extension style	Building block type
Network	Ethernet, CC-Link IE controller network, CC-Link IE field network, CC-Link, CC-Link/LT, MELSECNET/H, SSCNETIII (H), AnyWire, RS-232, RS-422

Programmable Controller

MELSEC-L Series



“Light & Flexible” condensing various functions easily and flexibly.

- ◎CPU equipped as a standard with various functions including counter, positioning and CC-Link.
- ◎The base-less structure with high degree of freedom saves space in the control panel.
- ◎Easily confirm the system status and change the settings with the display unit.
- ◎Seven models are available in program capacities from 20 k steps to 260 k steps.

Product specifications

Program capacity	20 k steps/60 k steps/260 k steps
Number of input/output points [X/Y]	1024 points/4096 points
Number of input/output device points [X/Y]	8192 points
Basic instruction processing speed (LD instruction)	60 ns/ 40 ns/ 9.5 ns
External connection interface	USB, Ethernet, RS-232, SD memory card, CC-Link (L26CPU-BT/PBT)
Function modules	I/O, analog, high-speed counter, positioning, simple motion, temperature control, network module
Unit expansion style	Base-less structure
Network	Ethernet, CC-Link IE Field network, CC-Link, CC-Link/LT, SSCNETIII(H), RS-232, RS-422

HMI

Graphic Operation Terminal GOT1000 Series GT16 Model



Full-flat face body integrating all the functions required of a HMI.

- ◎All models are equipped with Ethernet, RS-422/485 and RS-232 interfaces enabling a diverse range of communications.
- ◎A multimedia unit and a video/RGB unit (optional) are supported for smooth recording and playback of moving images.
- ◎USB host and device ports are provided as a standard on the front panel. Easily connect to a personal computer for data exchange.
- ◎Large 15MB memory capacity allows you to use optional functions and real parts, etc., without worrying about memory space.

Product Specifications

Screen size	15", 12.1", 10.4", 8.4", 5.7"
Resolution	XGA, SVGA, VGA
Intensity adjustment	8-step or 4-step adjustment
Touch panel type	Analog resistive film
Built-in interface	RS-232, RS-422/485, Ethernet, USB, CF card
Applicable software	GT Works3
Input power supply voltage	100 to 240VAC (+10%, -15%), 24VDC (+25%, -20%)





**Inverter | FREQROL-A700 Series**



**High-function, high-performance inverter**

- ◎High-accuracy, high-response speed control using real sensor-less vector control is possible with a general-purpose inverter having no PLG (encoder) (200% torque/0.3 Hz (3.7 K or less)).
- ◎Full-scale vector control is possible when used in combination with a motor with PLG (when using option).
- ◎The built-in noise filter (EMC filter) helps reduce noise generated from the inverter.
- ◎This series supports IPM motor operation. Use auto tuning to operate with the optimum motor characteristics.

**Product Specifications**

Inverter capacity	200V class: 0.4kW to 90kW, 400V class: 0.4kW to 500kW
Control method	IPM control, Soft-PWM control, high-carrier frequency PWM control (Select from V/F, advanced flux vector, or real sensor-less vector), vector control (when using options)
Output frequency range	0.2 to 400Hz (real sensor-less vector, upper frequency during vector control is 120Hz)
PM offline auto tuning	200V class: 0.4K to 1.5K (150%3%ED), 2.2K/3.7K (100%3%ED) When using the MM-CF Series, the motor constants, etc., are automatically measured for operation with the optimum motor characteristics (IPM motors other than the MM-CF Series, and other IPM motor brands are also supported)
Starting torque	200% 0.3Hz (3.7K or less), 150% 0.3Hz (5.5K or more) (when using real sensor-less vector, vector control)

**Magnetic motor starters | MS-T Series**



**Collection large satisfaction in a small body.**

- ◎The industry-leading smallest dimension\* is achieved in a general purpose Magnetic Contactor.
- \*In general Magnetic Contactors of 10A frame class (our survey in September, 2012)
- ◎Standard terminal cover improves safety.
- ◎Wide range of operation coil ratings available. Reducing inventory types and supporting selections.
- ◎Supporting your overseas business with compliance to various International Standards.

**Product specifications**

Frame	10 A to 32 A
Applicable standards	Certification to various standards including IEC, JIS, UL and CE (TÜV, CCC certification pending)
Terminal cover	Standard terminal cover improves safety, simplifies ordering, and reduces inventory, etc.
Improved wiring	Wiring and operability are improved with Streamling wiring terminal BC specifications.
Operation coil rating	Wide range of operation coil ratings reduces number of coil types from 14 (N Series) to seven types and simplifies selection.
Option units	Diverse lineup includes auxiliary contact blocks, surge absorber unit, and mechanical interlock unit.

**Robot | MELFA F Series**



**High speed, high precision and high reliability industrial robot**

- ◎Compact body and slim arm design, allowing operating area to be expanded and load capacity increased.
- ◎The fastest in its class using high performance motors and unique driver control technology.
- ◎Improved flexibility for robot layout design considerations.
- ◎Optimal motor control tuning set automatically based on operating position, posture, and load conditions.

**Product Specifications**

Degrees of freedom	Vertical:6 Horizontal:4
Installation	Vertical:Floor-mount, ceiling mount, wall mount (Range of motion for J1 is limited) Horizontal:Floor-mount
Maximum load capacity	Vertical:2-7kg Horizontal:3-20kg
Maximum reach radius	Vertical:504-908mm Horizontal:350-1,000mm

## Global FA Centers

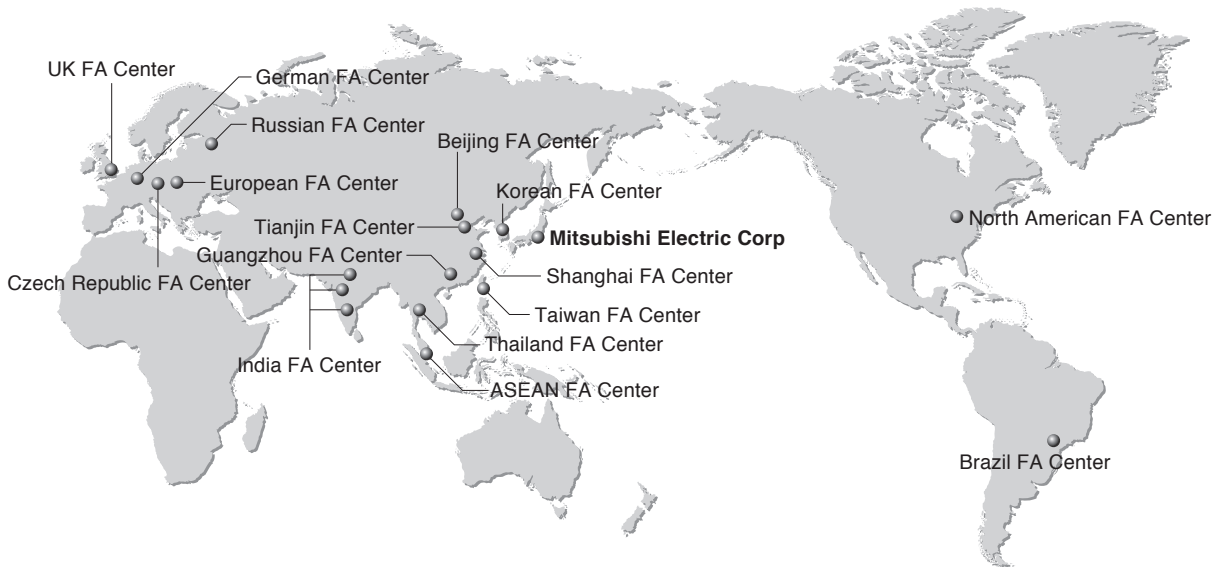

### China

**Shanghai FA Center**  
**MITSUBISHI ELECTRIC AUTOMATION (CHINA) LTD. Shanghai FA Center**  
 10F, Mitsubishi Electric Automation Center, No.1386 Hongqiao Road, Changning District, Shanghai, China  
 Tel: 86-21-2322-3030 Fax: 86-21-2322-3000 (9611#)

**Beijing FA Center**  
**MITSUBISHI ELECTRIC AUTOMATION (CHINA) LTD. Beijing FA Center**  
 Unit 908, Office Tower 1, Henderson Centre, 18 Jianguomennei Avenue, Dongcheng District, Beijing, China  
 Tel: 86-10-6518-8830 Fax: 86-10-6518-3907

**Tianjin FA Center**  
**MITSUBISHI ELECTRIC AUTOMATION (CHINA) LTD. Tianjin FA Center**  
 Room 2003 City Tower, No.35, Youyi Road, Hexi District, Tianjin, China  
 Tel: 86-22-2813-1015 Fax: 86-22-2813-1017

**Guangzhou FA Center**  
**MITSUBISHI ELECTRIC AUTOMATION (CHINA) LTD. Guangzhou FA Center**  
 Room 1609, North Tower, The Hub Center, No.1068, Xingang East Road, Haizhu District, Guangzhou, China  
 Tel: 86-20-8923-6730 Fax: 86-20-8923-6715

### Taiwan

**Taiwan FA Center**  
**SETSUYO ENTERPRISE CO., LTD.**  
 3F, No.105, Wugong 3rd Road, Wugu District, New Taipei City 24889, Taiwan, R.O.C.  
 Tel: 886-2-2299-9917 Fax: 886-2-2299-9963

### Korea

**Korean FA Center**  
**MITSUBISHI ELECTRIC AUTOMATION KOREA CO., LTD. (Service)**  
 B1F, 2F, 1480-6, Gayang-Dong, Gangseo-Gu, Seoul, 157-200, Korea  
 Tel: 82-2-3660-9630 Fax: 82-2-3663-0475

### Thailand

**Thailand FA Center**  
**MITSUBISHI ELECTRIC AUTOMATION (THAILAND) CO., LTD.**  
 Bang-Chan Industrial Estate No.111 Soi Serithai 54, T.Kannayao, A.Kannayao, Bangkok 10230, Thailand  
 Tel: 66-2906-3238 Fax: 66-2906-3239

### ASEAN

**ASEAN FA Center**  
**MITSUBISHI ELECTRIC ASIA PTE. LTD. ASEAN Factory Automation Centre**  
 307 Alexandra Road, Mitsubishi Electric Building, Singapore 159943  
 Tel: 65-6470-2480 Fax: 65-6476-7439

### India

**India FA Center**  
**MITSUBISHI ELECTRIC INDIA PVT. LTD. India Factory Automation Centre**  
 Emerald House, EL-3, J Block, M.I.D.C., Bhosari, Pune, 411026, Maharashtra State, India  
 Tel: 91-20-2710-2000 Fax: 91-20-2710-2100

**MITSUBISHI ELECTRIC INDIA PVT. LTD. India Factory Automation Centre Gurgaon Branch**  
 2nd Floor, Tower A & B, Cyber Greens, DLF Cyber City, DLF Phase - III, Gurgaon - 122002 Haryana, India  
 Tel: 91-124-463-0300 Fax: 91-124-463-0399

**MITSUBISHI ELECTRIC INDIA PVT. LTD. India Factory Automation Centre Bangalore Branch**  
 Prestige Emerald, 6th Floor, Municipal No.2, Madras Bank Road, Bangalore 560001, India  
 Tel: 91-80-4020-1600 Fax: 91-80-4020-1699

### America

**North American FA Center**  
**MITSUBISHI ELECTRIC AUTOMATION, INC.**  
 500 Corporate Woods Parkway, Vernon Hills, IL 60061, U.S.A.  
 Tel: 1-847-478-2100 Fax: 1-847-478-2253

### Brazil

**Brazil FA Center**  
**MITSUBISHI ELECTRIC DO BRASIL COMÉRCIO E SERVIÇOS LTDA.**  
 Rua Jussara, 1750 - Bloco B- Sala 01, Jardim Santa Cecilia - CEP 06465-070, Barueri - SP, Brasil  
 Tel: 55-11-4689-3000 Fax: 55-11-4689-3016

### Europe

**European FA Center**  
**MITSUBISHI ELECTRIC EUROPE B.V. Polish Branch**  
 32-083 Balice ul. Krakowska 50, Poland  
 Tel: 48-12-630-47-00 Fax: 48-12-630-47-01

**German FA Center**  
**MITSUBISHI ELECTRIC EUROPE B.V. German Branch**  
 Gothaer Strasse 8, D-40880 Ratingen, Germany  
 Tel: 49-2102-486-0 Fax: 49-2102-486-1120

**UK FA Center**  
**MITSUBISHI ELECTRIC EUROPE B.V. UK Branch**  
 Travellers Lane, Hatfield, Hertfordshire, AL10 8XB, U.K.  
 Tel: 44-1707-28-8780 Fax: 44-1707-27-8695

**Czech Republic FA Center**  
**MITSUBISHI ELECTRIC EUROPE B.V. Czech Branch**  
 Avenir Business Park, Radicka 751/113e, 158 00 Praha5, Czech Republic  
 Tel: 420-251-551-470 Fax: 420-251-551-471

**Russian FA Center**  
**MITSUBISHI ELECTRIC EUROPE B.V. Russian Branch St. Petersburg office**  
 Piskarevsky pr. 2, bld 2, lit "Sch", BC "Benua", office 720; 195027, St. Petersburg, Russia  
 Tel: 7-812-633-3497 Fax: 7-812-633-3499

Microsoft, Windows, Internet Explorer, and Windows Vista are either registered trademarks or trademarks of Microsoft Corporation in the United States and/or other countries.  
Celeron and Pentium are registered trademarks of Intel Corporation.  
Ethernet is a trademark of Xerox Corporation.  
All other company names and product names used in this document are trademarks or registered trademarks of their respective companies.

Mitsubishi Electric Corporation Nagoya Works is a factory certified for ISO14001 (standards for environmental management systems) and ISO9001(standards for quality assurance management systems)

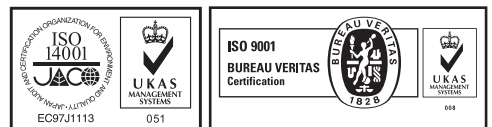

# SERVO AMPLIFIERS & MOTORS

## Safety Warning

To ensure proper use of the products listed in this catalog, please be sure to read the instruction manual prior to use.

Country/Region	Sales office	Tel/Fax
USA	MITSUBISHI ELECTRIC AUTOMATION, INC. 500 Corporate Woods Parkway, Vernon Hills, IL 60061, U.S.A.	Tel : +1-847-478-2100 Fax : +1-847-478-2253
Brazil	MITSUBISHI ELECTRIC DO BRASIL COMÉRCIO E SERVIÇOS LTDA. Rua Jussara, 1750 - Bloco B- Sala 01, Jardim Santa Cecília - CEP 06465-070, Barueri - SP, Brasil	Tel : +55-11-4689-3000 Fax : +55-11-4689-3016
Germany	MITSUBISHI ELECTRIC EUROPE B.V. German Branch Gothaer Strasse 8, D-40880 Ratingen, Germany	Tel : +49-2102-486-0 Fax : +49-2102-486-1120
UK	MITSUBISHI ELECTRIC EUROPE B.V. UK Branch Travellers Lane, Hatfield, Hertfordshire, AL10 8XB, U.K.	Tel : +44-1707-28-8780 Fax : +44-1707-27-8695
Italy	MITSUBISHI ELECTRIC EUROPE B.V. Italian Branch VIALE COLLEONI 7 - 20864 Agrate Brianza (Milano), Italy	Tel : +39-039-60531 Fax : +39-039-6053-312
Spain	MITSUBISHI ELECTRIC EUROPE, B.V. Spanish Branch Carretera de Rubí 76-80-AC.420, E-08190 Sant Cugat del Vallés (Barcelona), Spain	Tel : +34-935-65-3131 Fax : +34-935-89-1579
France	MITSUBISHI ELECTRIC EUROPE B.V. French Branch 25, Boulevard des Bouvets, F-92741 Nanterre Cedex, France	Tel : +33-1-55-68-55-68 Fax : +33-1-55-68-57-57
Czech Republic	MITSUBISHI ELECTRIC EUROPE B.V. Czech Branch Avenir Business Park, Radicka 751/113e, 158 00 Praha5, Czech Republic	Tel : +420-251-551-470 Fax : +420-251-551-471
Poland	MITSUBISHI ELECTRIC EUROPE B.V. Polish Branch 32-083 Balice ul. Krakowska 50, Poland	Tel : +48-12-630-47-00 Fax : +48-12-630-47-01
Russia	MITSUBISHI ELECTRIC EUROPE B.V. Russian Branch St. Petersburg office Piskarevsky pr. 2, bld 2, lit "Sch", BC "Benuea", office 720; 195027, St. Petersburg, Russia	Tel : +7-812-633-3497 Fax : +7-812-633-3499
South Africa	ADROIT TECHNOLOGIES 20 Waterford Office Park, 189 Witkoppen Road, ZA-Fourways, South Africa	Tel : +27-11-658-8100 Fax : +27-11-658-8101
China	MITSUBISHI ELECTRIC AUTOMATION (CHINA) LTD. No.1386 Hongqiao Road, Mitsubishi Electric Automation Center, Changning District, Shanghai, China	Tel : +86-21-2322-3030 Fax : +86-21-2322-3000
Taiwan	SETSUYO ENTERPRISE CO., LTD. 6F, No.105, Wugong 3rd Road, Wugu District, New Taipei City 24889, Taiwan, R.O.C.	Tel : +886-2-2299-2499 Fax : +886-2-2299-2509
Korea	MITSUBISHI ELECTRIC AUTOMATION KOREA CO., LTD. (Sales) 3F, 1480-6, Gayang-Dong, Gangseo-Gu, Seoul, 157-200, Korea	Tel : +82-2-3660-9510 Fax : +82-2-3664-8372/8335
Singapore	MITSUBISHI ELECTRIC ASIA PTE. LTD -Industrial Division 307 Alexandra Road, Mitsubishi Electric Building, Singapore 159943	Tel : +65-6473-2308 Fax : +65-6476-7439
Thailand	MITSUBISHI ELECTRIC AUTOMATION (THAILAND) CO., LTD. Bang-Chan Industrial Estate No.111 Soi Serithai 54, T.Kannayao, A.Kannayao, Bangkok 10230, Thailand	Tel : +66-2906-3238 Fax : +66-2906-3239
Indonesia	P. T. Autoteknindo Sumber Makmur Muara Karang Selatan, Block A / Utara No.1 Kav. No. 11, Kawasan Industri Pergudangan, Jakarta- Utara 14440, P.O.Box 5045, Indonesia	Tel : +62-21-663-0833 Fax : +62-21-663-0832
India	MITSUBISHI ELECTRIC INDIA PVT. LTD. Emerald House, EL-3, J Block, M.I.D.C., Bhosari, Pune, 411026, Maharashtra State, India	Tel : +91-20-2710-2000 Fax : +91-20-2710-2100
Australia	MITSUBISHI ELECTRIC AUSTRALIA PTY. LTD. 348 Victoria Road, P.O. Box 11, Rydalmere, N.S.W 2116, Australia	Tel : +61-2-9684-7777 Fax : +61-2-9684-7245

## MITSUBISHI ELECTRIC CORPORATION

HEAD OFFICE: TOKYO BUILDING, 2-7-3, MARUNOUCHI, CHIYODA-KU, TOKYO 100-8310, JAPAN  
NAGOYA WORKS: 1-14, YADA-MINAMI 5, HIGASHI-KU, NAGOYA, JAPAN