

CONTENTS

I. Safety	3
1.1 Safety information.....	3
1.2 Before using.....	8
1.3 Designed Standards for Implementation.....	10
II. Product	11
2.1 Product model naming rule.....	11
2.2 Optional function naming rule.....	11
2.3 Nameplate	13
2.4 Appearance.....	14
2.5 Technical Specifications	16
III. Keypad panel.....	20
3.1 Panel Illustrations.....	20
3.2 Panel Structure.....	23
3.3 Panel Operating	25
3.4 Parameters Setting	25
3.5 Function Codes Switchover In/Between Code-Groups.....	26
3.6 Panel Display	27
IV. Installation & Connection	29
4.1 Installation.....	29
4.2 Connection	29
4.3 Measurement of main circuit.....	32
4.4 Function of Control Terminals.....	36
4.5 Wiring Recommended.....	38
4.6 Lead Section Area of Protect Conductor(grounding wire)	38
4.7 Overall connection.....	39
4.8 Basic methods of suppressing the noise	40
V. Operation and Simple Running	46

5.1	Basic conception.....	46
5.2	Keypad panel and operation method.....	47
5.3	Illustration of basic operation.....	53
VI.	Function Parameters	60
6.1	Basic Parameters.....	60
6.2	Operation Control	70
6.3	Multifunctional Input and Output Terminals.....	83
6.4	Analog Input and Output.....	94
6.5	Pulse input and output.....	98
6.6	Multi-stage Speed Control.....	101
6.7	Auxiliary Functions.....	103
6.8	Malfunction and Protection.....	111
6.9	Parameters of the motor.....	115
6.10	Communication parameters.....	119
6.11	PID parameters.....	122
6.13	Torque control parameters.....	128
6.14	Parameters of the second motor.....	130
6.15	Parameters display.....	130
Appendix 1	Trouble Shooting.....	132
Appendix 2	Reference wiring of water system.....	134
Appendix 3	Products and Structure	138
Appendix 4	Selection of Braking Resistance	142
Appendix 5	Communication Manual.....	144
Appendix 6	Zoom Table of Function Code	154
Appendix 7	Encoder expansion card.....	187
Appendix 8	Master/slave control.....	194
Appendix 9	Input filter model and dimension.....	201
Appendix 10	Bus communication.....	207

I. Safety

Read this manual carefully so that you have a thorough understanding. Installation, commissioning or maintenance may be performed in conjunction with this chapter. EURA will assume no liability or responsibility for any injury or loss caused by improper operation.

1.1 Safety information

1.1.1 Application Area

The equipment described is intended for industrial motor speed control utilising AC induction motors.

1.1.2 Safety definition

Danger: series physical injury or even death may occur if not follow relevant requirements.









Warning: Physical injury or damage to the devices may occur if not follow relevant requirements.

Note: Physical hurt may occur if not follow relevant requirements.

Qualified electricians: People working on the device should take part in professional electrical and safety training, receive the certification and be familiar with all steps and requirements of installing, commissioning, operating and maintaining the device to avoid any emergency.





1.1.3 Warning symbols

Warning caution you about conditions which can result in serious injury or death and/or damage to the equipment, and advice on how to avoid the danger. Following warning symbols are used in this manual.

Symbols	Name	Instruction	Abbreviation
 Danger	Electrical danger	Serious physical injury or even may occur if not follow the relative requirements.	
 Hot sides	Hot sides	Sides of the device may become hot. Do not touch.	
 Warning	Warning	Physical injury or damage to the devices may occur if not follow the relative requirements.	
 Do not	Electrostatic discharge	Damage to the PCB board may occur if not follow the relative requirements.	

Note	Note	Physical hurt may occur if not follow the relative requirements.	Note
-------------	------	--	-------------

1.1.4 Safety guidelines

	<p>◇ Only qualified electricians are allowed to operate on the inverter.</p> <p>◇ Do not carry out any wiring and inspection or changing components when the power supply is applied. Ensure all input power supply is disconnected before wiring and checking and always wait for at least the time designated on the inverter or until the DC bus voltage is less than 36V. Below is the table of the waiting time:</p> <table border="1" data-bbox="200 509 868 751"> <thead> <tr> <th data-bbox="200 509 543 571">inverter model</th> <th data-bbox="543 509 868 571">Min theoretical waiting time</th> </tr> </thead> <tbody> <tr> <td data-bbox="200 571 543 628">400V 1.5kW – 110kW</td> <td data-bbox="543 571 868 628">5 minutes</td> </tr> <tr> <td data-bbox="200 628 543 689">400V 132kW – 315kW</td> <td data-bbox="543 628 868 689">30 minutes</td> </tr> <tr> <td data-bbox="200 689 543 751">400V above 350kW</td> <td data-bbox="543 689 868 751">45 minutes</td> </tr> </tbody> </table>	inverter model	Min theoretical waiting time	400V 1.5kW – 110kW	5 minutes	400V 132kW – 315kW	30 minutes	400V above 350kW	45 minutes
inverter model	Min theoretical waiting time								
400V 1.5kW – 110kW	5 minutes								
400V 132kW – 315kW	30 minutes								
400V above 350kW	45 minutes								
	<p>◇ The base of the radiator may become hot during running. Do not touch to avoid hurt.</p>								
	<p>◇ Do not refit the inverter unauthorzedly; otherwise fire, electric shock or other injury may occur.</p> <p>◇ Never touch power terminals internal inverter to avoid any electric shock.</p> <p>◇ Do not connect input power supply onto U, V, W or PE/E terminals.</p> <p>◇ Do not install inverter directly under sunshine, do not block up the cooling hole.</p> <p>◇ All safety covers should be well fixed before inverter is power connected, to avoid any electric shock.</p>								
	<p>◇ The electrical parts and components inside the inverter are electrostatic. Take measurements to avoid electrostatic discharge relevant operation.</p>								

1.1.5 Delivery and installation



- ◇ Please install the inverter on fire-retardant material and keep the inverter away from combustible materials.
- ◇ Connect the braking optional parts (braking resistors, braking units or feedback units) according to the wiring diagram.
- ◇ Do not operate on the inverter if there is any damage or components loss to the inverter.
- ◇ Do not touch the inverter with wet items or body, otherwise electric shock may occur.
- ◇ Select appropriate moving and installing tools to ensure a safe and normal running of the inverter and avoid physical injury or death. For physical safety, the erector should take some mechanical protective measurements, such as wearing exposure shoes and working uniforms.
- ◇ Ensure to avoid physical shock or vibration during delivery and installation.
- ◇ Do not carry the inverter by its cover to avoid cover falling off.
- ◇ Install away from children and other public placers.
- ◇ Derating must be considered when the drive is installed at high altitude, greater than 1000m. This is because the cooling effect of drive is deteriorated due to the thin air, as shown in Fig1-1 that indicates the relationship between the elevation and rated current of the drive.
- ◇ Forbidden screws, cables and other conductive items to fall inside the inverter.
- ◇ Proper grounding should be ensured with grounding resistance not exceeding 4Ω ; separate grounding is required for motor and inverter. Grounding with series connection is forbidden.
- ◇ R, S and T are the input terminals of the power supply, while U, V and

We are the motor terminals. Please connect the input power cables and motor cables with proper techniques; otherwise the damage to the inverter may occur.

◇ If inverter is installed in a control cabinet, smooth ventilation should be ensured and inverter should be installed vertically (as shown in Fig1-2). If there are several inverters in one cabinet, in order to ensure ventilation, please install inverters side by side. If it is necessary to install several inverters up and down, please add heat-insulation plate (as shown in Fig1-3).

◇ Signal line should not be too long to avoid any increase with common mode interference.

◇ Before using the drive, the insulation of the motors must be checked, especially, if it is used for the first time or if it has been stored for a long time. This is to reduce the risk of the drive from being damaged by the poor insulation of the motor.

◇ Do not connect any varistor or capacitor to the output terminals of the drive, because the drive's output voltage waveform is pulse wave, otherwise tripping or damaging of components may occur; in addition, do not install circuit breaker or contactor at the output side of the drive as shown in Fig 1-4.

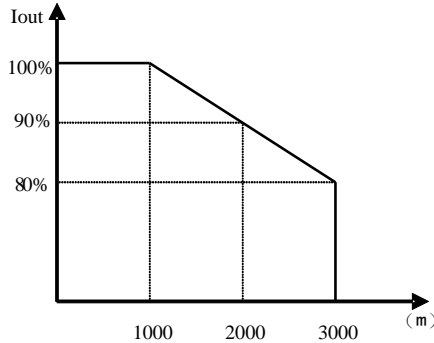

Fig 1-1 Derating drive's output current with altitude

Installing vertically

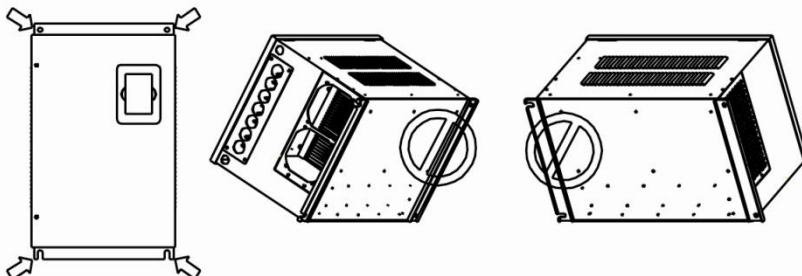

Fig 1-2 Installing vertically

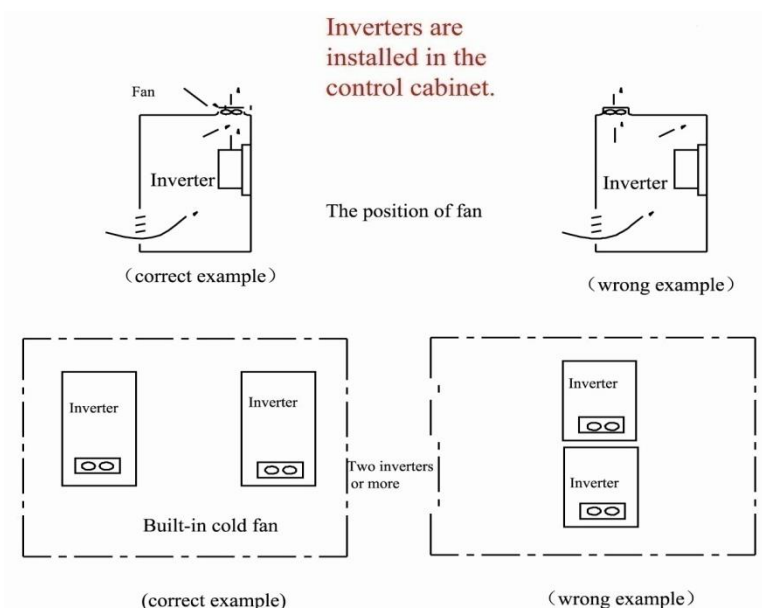

Fig 1-3 Installed in the cabinet

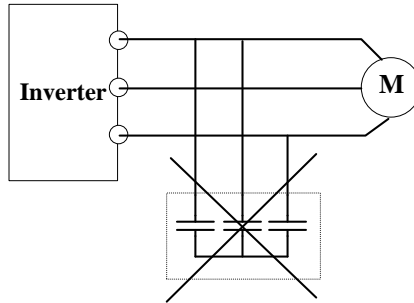

Fig 1-4 Capacitors are prohibited to be used.

1.2 Before using

1.2.1 Unpacking inspection



Check as followings after receiving products:

- | |
|---|
| 1. Check that there are no damage and humidification to the package. If not, please contact with local agents or company offices. |
| 2. Check the information on the type designation label on the outside of the package to verify that the drive is of the correct type. If not, please contact with local dealers or company offices. |
| 3. Check that there are no signs of water in the package and no signs of damage or breach to the inverter. If not, please contact with local dealers or company offices. |
| 4. Check the information on the type designation label on the outside of the package to verify that the nameplate is of the correct type. If not, please contact with local dealers or company offices. |
| 5. Check to ensure the accessories (including user manual, control keypad and extension card) inside the device is complete. If not, please contact with local dealers or company offices. |

1.2.2 Application confirmation



Check the machine before beginning to use the inverter:

- | |
|---|
| 1. Check the load type to verify that there is no overload of the inverter during work and check that whether the drive needs to modify the power degree. |
| 2. Check that the actual current of the motor is less than the rated current of the |

inverter.
3. Check that the control accuracy of the load is the same of the inverter.
4. Check that the incoming supply voltage is correspondent to the rated voltage of the inverter.
5. Check that the communication needs option card or not.

1.2.3 Environment



Check as followings before the actual installation and usage:

1. Check that the ambient temperature of the inverter is below 50°C. If exceeds, derate 3% for every additional 1°C. Additionally, the inverter can not be used if the ambient temperature is above 60°C. Note: for the cabinet inverter, the ambient temperature means the air temperature inside the cabinet.
2. Check that the ambient temperature of the inverter in actual usage is above -10°C. If not, add heating facilities. Note: for the cabinet inverter, the ambient temperature means the air temperature inside the cabinet.
3. Check that the altitude of the actual usage site is below 1000m. If exceeds, derate 1% for every additional 100m.
4. Check that the humidity of the actual usage site is below 90% and condensation is not allowed. If not, add additional protection inverters.
5. Check that the actual usage site is away from direct sunlight and foreign objects cannot enter the inverter. If not, add additional protective measures.
6. Check that there is no conductive dust or flammable gas in the actual usage site. If not, add additional protection to inverters.

1.2.4 Installation confirmation



Check as followings after the installation:

1. Check that the load range of the input and output cables meet the need of actual load.
2. Check that the accessories of the inverter are correctly and properly installed. The installation cables should meet the needs of every component (including input chokes, input filters, output chokes, output filters, DC choke, braking unit and braking resistor.)

3. Check that the inverter is installed on non-flammable materials and the calorific accessories (chokes and braking resistors) are away from flammable materials.
4. Check that all control cables and power cables are run separately and the rotation complies with EMC requirement.
5. Check that all grounding systems are properly grounded according to the requirements of the inverters.
6. Check that the free space during installation is sufficient according to the instructions in user manual.
7. Check that the installation conforms to the instructions in user manual. The drive must be installed in a vertical position.
8. Check that the external connection terminals are tightly fastened and the torque is appropriate.
9. Check that there are no screws, cables and other conductive items left in the inverter. If not, get them out.

1.2.5 Basic commission



Complete the basic commissioning as followings before actual utilization:

1. Select the motor type, set correct motor parameters and select control mode of the inverter according to the actual motor parameters.
2. Auto-tune. If possible, disconnected from the motor load to start dynamic auto-tune. Or if not, static auto-tune is available.
3. Adjust acceleration/deceleration time according to actual running of load.
4. Commission the device via jogging and check that the rotation direction is as required. If not, change the rotation direction by changing the wiring of motor.
5. Set all control parameters and then operate.

1.3 Designed Standards for Implementation

- IEC/EN 61800-5-1: 2007 Adjustable speed electrical power drive systems safety requirements.
- IEC/EN 61800-3: 2004/ +A1: 2012 Adjustable speed electrical power drive systems-Part 3: EMC product standard including specific test methods.

II. Product

This manual offers a brief introduction of the installation connection for E2000 series inverters, parameters setting and operations, and should therefore be properly kept. Please contact manufacturer or dealer in case of any malfunction during application.

2.1 Product model naming rule

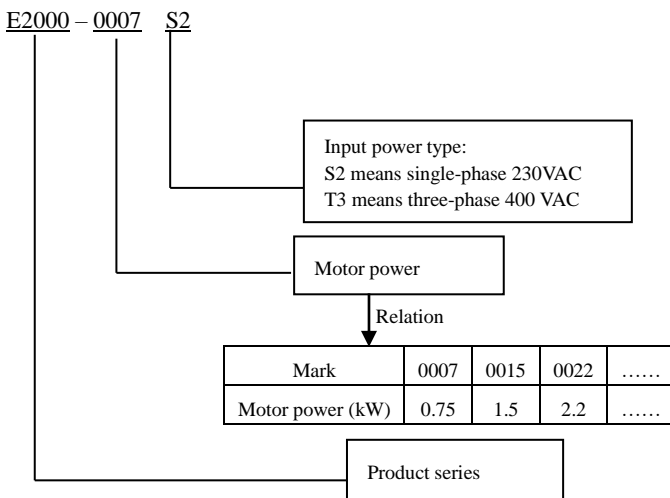

2.2 Function naming rule

E2 U5 F2 AF03 B1R3

Filter	R3	C3 level filter	Remarks 1
Braking type	B1	Dynamic braking	Remarks 2
Keypad	AF03	AF English no potentiometer LED keypad	Remarks 3
Communication	F2	Modbus is connected by terminal.	Remarks 4
Certificate	U5	UL+CE	Remarks 5
Structure code	E2	E2 structure	

Remarks:

1. Filter for 45kw and below 45kw includes R3 and R5. R3 is EMC C3 level standard (testing condition is 25m motor cable). R5 is EMC C3 level standard (testing condition is 10m unshielded motor cable). R5 is standard, R3 is optional. 55kw and above 55kw meet the need of EMC C3 level standard.
2. For 3-phase 400V 30kw and below 30kW, braking unit is standard.

For 1-phase 230V and 3-phase 37kW-110kW, braking unit is built-in and optional.
For 3-phase 230V, 1.5kW and below 1.5kW, 4.0kW~11kW, braking unit is standard.
For 132kW and above 132kW, there is no built-in braking unit.

3. Local keypad :

Structure code	Keypad code	Contents
E1	AE01	AE Chinese version without potentiometer
	AE02	AE Chinese version with potentiometer
	AE03	AE English version without potentiometer
	AE04	AE English version with potentiometer
E2~E6	AF01	AF Chinese version without potentiometer
	AF02	AF Chinese version with potentiometer
	AF03	AF English version without potentiometer
	AF04	AF English version with potentiometer
E7~CB, DC6, DD0~DD4, D6	A601	A6 Chinese LED without potentiometer
	A602	A6 Chinese LED with potentiometer
	A603	A6 English LED without potentiometer
	A604	A6 English LED with potentiometer
	A605	A6 Chinese 9-key LED without potentiometer
	A606	A6 Chinese 9-key LED with potentiometer
	A607	A6 English 9-key LED without potentiometer
	A608	A6 English 9-key LED with potentiometer
	A612	A6 Chinese LED with digital potentiometer
	A614	A6 English LED with digital potentiometer
	A902	A9 English LCD4 without potentiometer
	A904	A9 Chinese LCD4 without potentiometer

Remote keypad model:

Keypad	
A601	A6 Chinese LED without potentiometer
A602	A6 Chinese LED with potentiometer
A603	A6 English LED without potentiometer
A604	A6 English LED with potentiometer
A605	A6 Chinese 9-key LED without potentiometer
A606	A6 Chinese 9-key LED with potentiometer
A607	A6 English 9-key LED without potentiometer

A608	A6 English 9-key LED with potentiometer
A612	A6 Chinese LED with digital potentiometer
A614	A6 English LED with digital potentiometer
A902	A9 English LCD4 without potentiometer
A904	A9 Chinese LCD4 without potentiometer
AA01	AA Chinese LED without potentiometer
AA02	AA Chinese LED with potentiometer
AA03	AA English LED without potentiometer
AA04	AA English LED with potentiometer
AA05	AA Chinese/English LED without potentiometer

4. Communication

Structure code	Communication code	Contents
E1	F2	Modbus
E2 structure and above	F2	Modbus
	F4	CANOpen+Modbus
	F5	EtherCAT+Modbus
	F9	Profibus-DP+Modbus
	F12	BACnet+Modbus

5. Certificate



Certificate code	Contents	Inverter power
U1	CE	≤800 kW
U5	UL+CE	≤185 kW

2.3 Nameplate

Taking for instance the E2000 series 0.75kW inverter with 1-phase input, its nameplate is illustrated as Fig 1-1.

1Ph: single-phase input; 230V, 50/60Hz: input voltage range and rated frequency.

3Ph: 3-phase output; 4.5A, 0.75kW: rated output current and power;

 EURA DRIVES ELECTRIC CO.,LTD			
MODEL	E2000-0007S2	OPTION	E1U1F2AE02B1R3
INPUT	1PH AC	220 V	50/60 Hz
OUTPUT	3PH AC	0~INPUT V	4.5 A
	0.75kW		
  Made In China			

2.4 Product appearance

2.4.1 Appearance

The external structure of E2000 series inverter is classified into plastic and metal housings. Wall hanging type and cabinet type are adopted. Good poly-carbon materials are adopted through die-stamping for plastic housing with nice form, good strength and toughness. Taking E2000-0007S2 for instance, the external appearance and structure are shown as in below Fig.

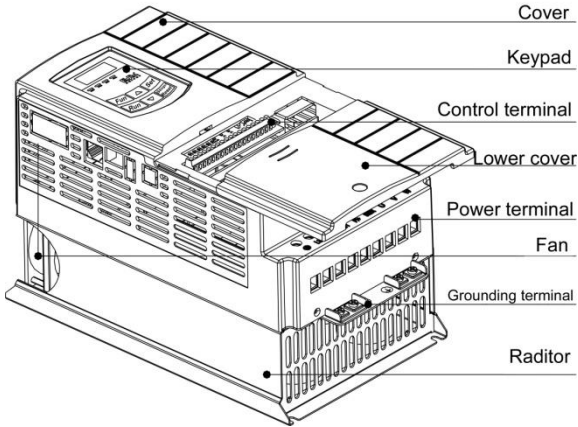

Metal housing uses advanced exterior plastic- spraying and powder-spraying process on the surface with elegant color and with detachable one-side door hinge structure adopted for front cover, convenient for wiring and maintenance. Taking E2000-0300T3 for instance, its appearance and structure are shown as in right Fig.

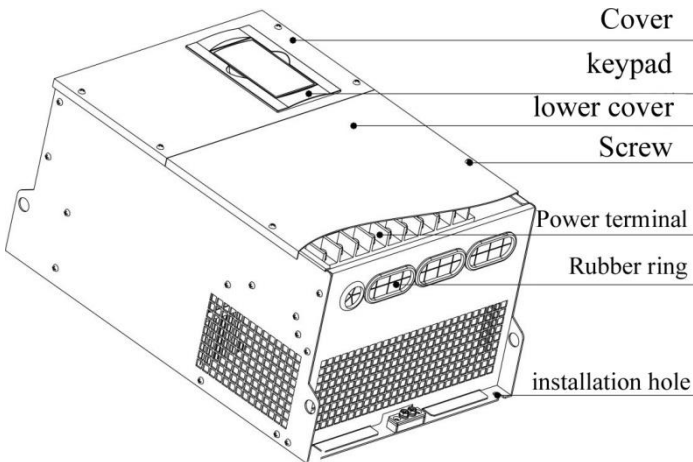

2.4.2 Interface

(1) E1 structure

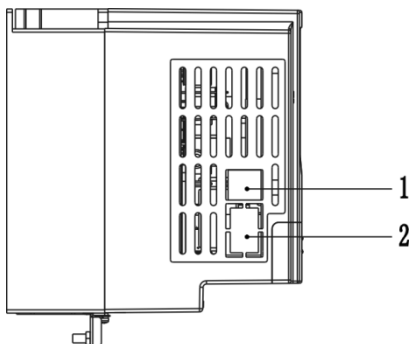

(2) E2-E6 structure

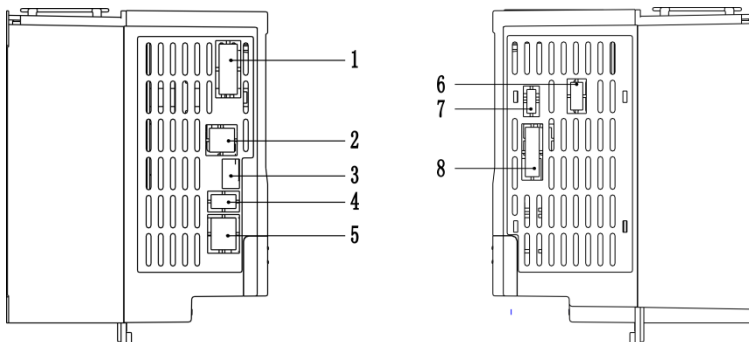

(3) E7 and Metal structure

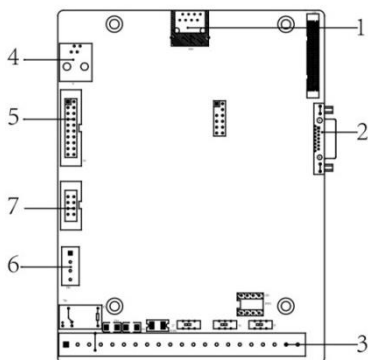

Table 2-1 E2000 interface introduction

Structure No.	Contents		
	E1 structure	E2~E6 structure	E7 and metal structure
1	8-core net cable remote keypad interface	Bus communication interface	8-core net cable remote keypad interface
2	RS-485 communication (A+,B-)	8-core net cable remote keypad interface	Bus communication interface
3		RS-485 communication (A+,B-)	Control terminal
4		Master/slave control expansion card interface	Master/slave control expansion card interface
5		Reserved	PG card expansion interface
6		STO card expansion interface (E4~E6)	RS-485 communication (A+,B-)
7		STO card expansion interface (E2,E3)	BACnet interface
8		PG card expansion interface	

2.5 Technical Specifications

Table2-2 Technical Specifications for E2000 Series Inverters

	Items	Contents
Input	Rated Voltage Range	3-phase 380-480V (+10%, -15%) ^{note 1} 3-phase 220V~240V ±15% 1-phase 220-240V ±15%
	Rated Frequency	50/60Hz
Output	Rated Voltage Range	3-phase 0-INPUT (V)
	Frequency Range	0.50~590.0Hz (In SVC control mode, the max frequency should be lower than 500Hz.)
Control Mode	Carrier Frequency	800~16000Hz; Fixed carrier-wave and random carrier-wave can be selected by F159.
	Input Frequency Resolution	Digital setting: 0.01Hz, analog setting: max frequency X 0.1%
	Control Mode	For induction motor: SVC (open-loop vector control) control, V/F control, VC (Closed-loop vector control) control For PMSM: SVC (open-loop vector control) control
	Start Torque	0.5 Hz / 150% (SVC), 0Hz/180% (VC), 5% of rated speed/100% of rated torque (PMSM SVC)
	Speed-control Scope	1:100 (SVC), 1:1000 (VC), 1:20 (in PMSM SVC)
	Steady Speed Precision	±0.5% (SVC) , ±0.02% (VC)
	Torque Control Precision	±5%
	Overload Capacity	150% rated current, 60 seconds.
	Torque Elevating	Auto torque promotion, Manual Torque Promotion includes 1-20 curves.

	V/F Curve	3 kinds of modes: beeline type, square type and under-defined V/F curve.
	Startup mode	Direct startup, speed track startup (V/F control)
	DC Braking	DC braking frequency: 0.20-50.00 Hz, braking time: 0.00~30.00s
	Jogging Control	Jogging frequency range: min frequency~ max frequency, jogging acceleration/deceleration time: 0.1~3000s
	Auto Circulating Running and multi-stage speed running	Auto circulating running or terminals control can realize 15-stage speed running.
	Built-in PID adjusting	Easy to realize a system for process closed-loop control
	Auto voltage regulation (AVR)	When source voltage changes, the modulation rate can be adjusted automatically, so that the output voltage is unchanged.
Operation Function	Frequency Setting	Potentiometer or external analog signal (0~5V, 0~10V, 0~20Ma); keypad (terminal)▲ / ▼ keys, external control logic and automatic circulation setting.
	Start/Stop Control	Terminal control, keypad control or communication control.
	Running Command Channels	3 kinds of channels from keypad panel, control terminal and MODBUS.
	Frequency Source	Frequency sources: given digit, given analog voltage, given analog current and given MODBUS
	Accessory frequency Source	7 kinds of accessory frequency
Optional	Built-in EMI filter, built-in braking unit, Modbus, tele-control panel	
Protection Function	Input phase loss, Output phase loss, input under-voltage, DC over-voltage, over-current, inverter over-load, motor over-load, current stall, over-heat, external disturbance, under-load, pressure control, analog line disconnected, PG line disconnection, keypad disconnection, oPEn protection, STO and STO1.	
Display	Keypad showing present output frequency, present rotate-speed (rpm), present output current, present output voltage, present linear-velocity, types of faults, and parameters for the system and operation; LED indicators showing the current working status of inverter.	
Environment Conditions	Equipment Location	In an indoor location, Prevent exposure from direct sunlight, Free from dust, tangy caustic gases, flammable gases, steam or the salt-contented, etc.
	Environment Temperature	-10℃~+50℃
	Environment Humidity	Below 90% (no water-bead coagulation)
	Vibration Strength	Below 0.5g (acceleration)
	Height above sea level	1000m or below
Protection level	IP20	
Pollution level	PD2	
Applicable Motor	0.2~800kW	

Note 1: under different voltage level, user should connect jumper on the pin board, the model of pin board is E2F3UZ00.

- 1) When input voltage is 380~420VAC, please connect CN2 to CN3 (380V Jumper).
- 2) When input voltage is 420~480VAC, please connect CN4 to CN5(480V Jumper).

The default system is 380~420VAC, if some operation is needed, please power off inverter and contact with profession

engineer.

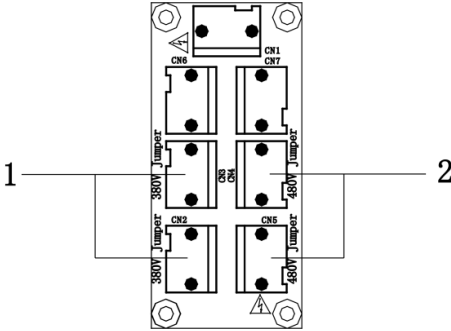

2.6 Options

Name	Model	Function	Remarks
Differential input PG card	EPG01	Card with Frequency-division output differential rotary encoder port. (Built-in)	5V power and differential output encoder are suitable. Please refer to Appendix 7.
	EPG03	Card with Frequency-division output differential rotary encoder port. (external)	Refer to user manual of expansion card.
Non-differential input PG card	EPG02	Card with frequency-division output non-differential rotary encoder port. (Built-in)	15V power and push-pull or open-collector output encoder are suitable. Please refer to Appendix 7.
	EPG04	Card with frequency-division output non-differential rotary encoder port. (external)	Refer to user manual of expansion card.
I/O expansion card 2 + differential input PG card	EPGDR01	4 terminals of digital input, and 2 terminals of relay output. Card with Frequency-division output differential rotary encoder port. (Built-in)	Refer to user manual of expansion card.
	EPGDR03	4 terminals of digital input, and 2 terminals of relay output. Card with Frequency-division output differential rotary encoder port. (Built-in)	
I/O expansion card 2 + non-differential input PG card	EPGDR02	4 terminals of digital input, and 2 terminals of relay output. Card with Frequency-division output non-differential rotary encoder port. (Built-in)	

	EPGDR04	4 terminals of digital input, and 2 terminals of relay output. Card with Frequency-division output non-differential rotary encoder port. (external)	
Input/output expansion card 2	EDR02	4 terminals of digital input, and 2 terminals of relay output. (Built-in)	Refer to FF00~FF09.
	EDR04	4 terminals of digital input, and 2 terminals of relay output. (external)	Refer to user manual of expansion card.
Detection temperature expansion card	ECPT01	Detecting motor temperature, which supports sensor type PT100 and PT1000.	
EtherCAT	EIB-ESSI01	EtherCAT communication (built-in)	Please refer to bus appendix 10.
	EIB-ESSE01	EtherCAT communication (external)	
CANopen	EIB-CSSI01	CANopen communication (built-in)	
	EIB-CSSE01	CANopen communication (external)	
Profibus	EIB-PDSSI01	Profibus-DP communication (built-in)	
	EIB-PDSSE01	Profibus-DP communication (external)	
BACnet	EIB-BSSI01	BACnet communication (built-in)	Refer to the user manual of BACnet ^{note}
	EIB-BSSE01	BACnet communication (external)	
Master/slave control expansion card	EMSC01	Master/slave control.	This card is needed when three or more inverters are connected together. Please refer to appendix 8.

Note:

1. BACnet card is only external now.
2. The structures of some frequency inverters with BACnet card change to E2. The models are as below:

Model	Power	Structure
E2000-0004S2	0.4	E2
E2000-0007S2	0.75	E2
E2000-0015S2	1.5	E2
E2000-0002T2	0.2	E2
E2000-0004T2	0.4	E2
E2000-0007T2	0.75	E2
E2000-0015T2	1.5	E2
E2000-0007T3	0.75	E2

III. Keypad panel

Two kinds of controllers (four lines of LCD and LED segment display) are available for E2000 series inverters. Refer to note for Fig3-1.

3.1 Panel Illustration

3.1.1 LED keypad

The panel covers three sections: data display section, status indicating section and keypad operating section, as shown in Fig. 3-1.

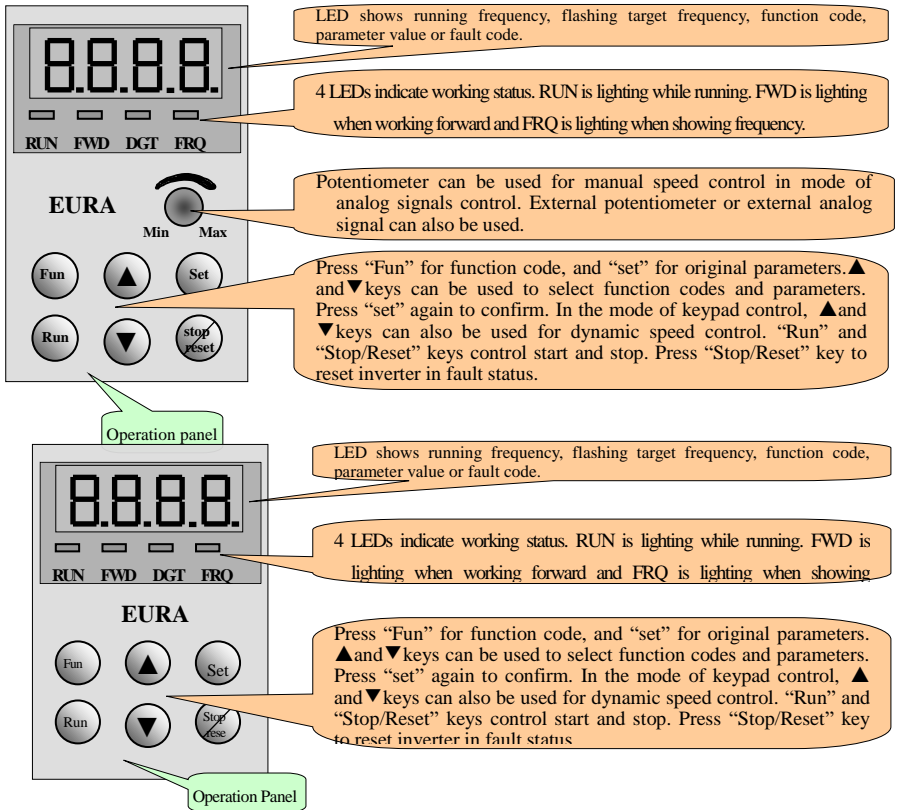

Fig.3-1 Operation Panels

3.1.2 LED remote keypad

The panel covers three sections: data display section, status indicating section and keypad operating section, as shown in Fig. 3-2.

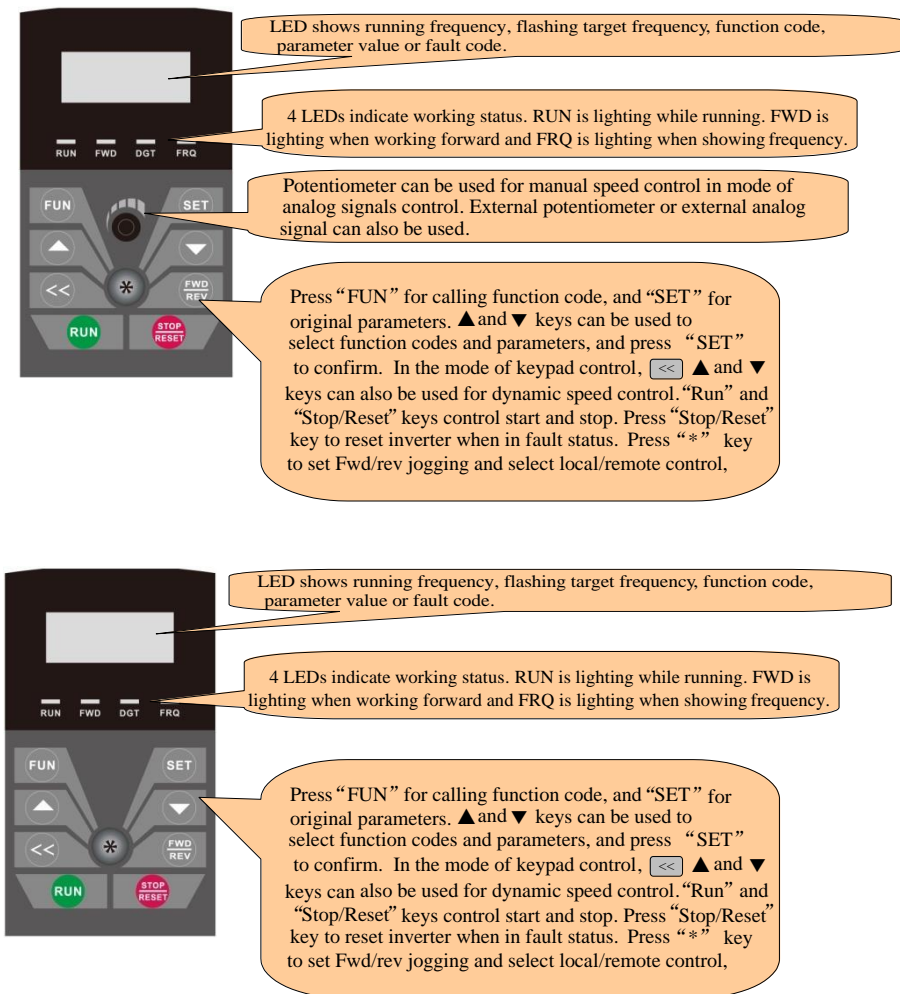

Fig.3-2 Operation Panels

3.1.3 Four lines of LCD keypad

The panel covers three sections: data display section, status indicating section and keypad operating section, as shown in Fig 3-2.

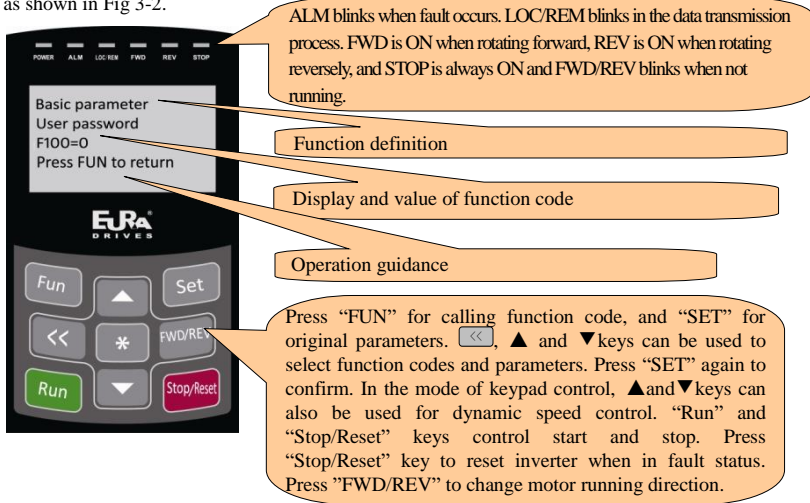

Fig.3-3 Operation Panels

Instructions for operation panel:

1. Operation panels of 30kW and below 30kW cannot be pulled out. Please select AA-A or A6-1-A control panel to realize remote control, which is connected by 8-core telephone cable.
2. Operation panels of 30kW and above 37kW can be pulled out. Please select A6-1-A control panel to realize remote control, which is connected by 8 core net cable.
3. A9 is four lines of LCD keypad, which is not standard configuration.

3.2 Panel structure

1. structure diagram

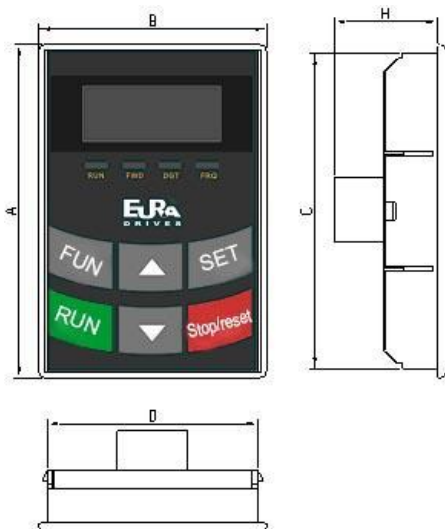

2. Structure size (Unit: mm)

Code	A	B	C	D	H	Opening size
AA	76	52	72	48	24	73*49
A6-1	124	74	120	70	26	121*71
A9	124	74	120	70	24	121*71

3. Panel mounting structure diagram

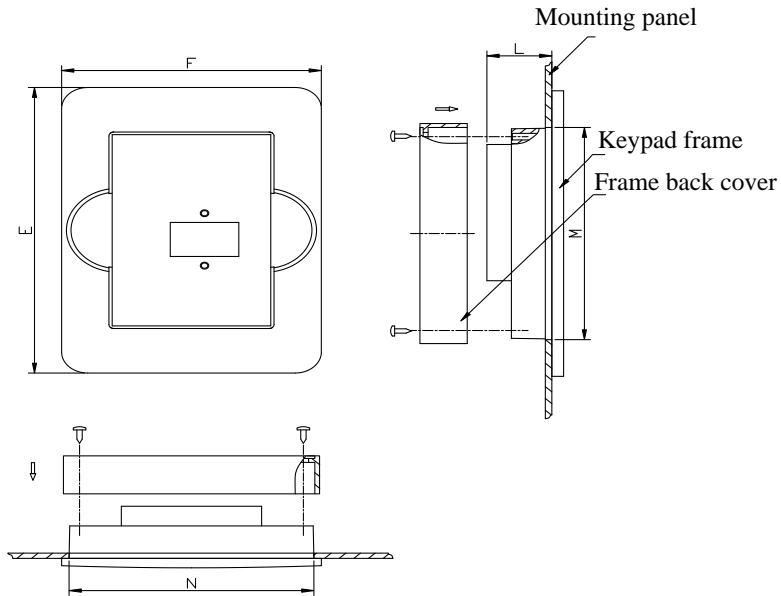

4. Panel mounting size (Unit: mm)

Code	Keypad panel size			Opening size	
	E	F	L	<u>N</u>	M
AA	109	80	20	75	81
A6-1	170	110	22	102	142
A9	170	110	22	102	142

5. Port of control panel

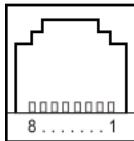

Pins	1	2	3	4	5	6	7	8
8 core	Potentiometer	5V	Grounding	Grounding	Signal 1	Signal 2	Signal 3	Signal 4

Note: The interface of control board should be completely consistent with the interface of the keypad panel.









so the line sequence should also be the same.

- The default remote-control wire length is 1m. The length of remote-control wire can be custom-made by users. If on the occasion of strong interference or the length is longer than 3m, please put a magnetic ring on the wire to avoid interference.



3.3 Panel Operating

All keys on the panel are available for user. Refer to Table 3-3 for their functions.

Table 3-3 **Uses of Keys**

Keys	Names	Remarks
	Fun	To call function code and switch over display mode.
	Set	To call and save data.
	Up	To increase data (speed control or setting parameters)
	Down	To decrease data (speed control or setting parameters)
	Run	To start inverter;
	Stop or reset	To stop inverter; to reset in fault status; to change function codes in a code group or between two code groups.
	Multi-function key	FWD/REV jogging and LOC/REM control is selected by multi-function key.
	Forward or reverse	Switchover of motor forward/reverse running
	Shift key	Shift and displaying items switchover.

Operating structure of four-line LCD:















The display interface of keypad will turn to malfunction interface when inverter trips into fault. User can check current, voltage and frequency by pressing . The specific values will be displayed on the fourth line of malfunction interface if the malfunction code is displayed as anyone of OC, OC1, OE, OL1 and OL2. “?A”, “?V” and “?Hz” for current, voltage and frequency respectively will be displayed if malfunction code is not one of above 6 malfunctions. User can check malfunction type and status of second (third) –to-last by pressing . After clearing the faults, keypad cannot response reset function but only shift function when pressing Reset/Stop key in non-malfunction interface; keypad can response reset function when pressing Reset/Stop key only in malfunction interface.

3.4 Parameters Setting

This inverter has numerous function parameters, which the user can modify to effect different modes of operation control. User needs to realize that if user sets password valid (F107=1), user’s password must be

entered first if parameters are to be set after power off or protection is effected, i.e., to call F100 as per the mode in Table 2-2 and enter the correct code. User's password is invalid before delivery, and user could set corresponding parameters without entering password.

Table 3-2 Steps for Parameters Setting

Steps	Keys	Operation	Display
1		Press "Fun" key to display function code	
2	 or 	Press "Up" or "Down" to select required function code	
3		To read data set in the function code	
4	 or 	To modify data	
5		To display corresponding function code after saving the set data	
		To display the current function code	

The above-mentioned step should be operated when inverter is in stop status.

3.5 Function Codes Switchover in/between Code-Groups

It has more than 300 parameters (function codes) available to user, divided into 10 sections as indicated in Table 3-3.

Table 3-3 Function Code Partition

Group Name	Function Code Range	Group Name	Function Code Range
Basic Parameters	F1	Parameters of the motor	F8
Run Control Mode	F2	Communication function	F9
Multi-functional input/output terminal	F3	PID parameter setting	FA
Analog signals and pulse of input/output	F4	Torque control	FC
Multi-stage speed parameters	F5	The second motor parameters	FE
Subsidiary function	F6	IO expansion	FF
Timing control and protection function	F7	Parameters display	H0

As parameters setting costs time due to numerous function codes, such function is specially designed as "Function Code Switchover in a Code Group or between Two Code-Groups" so that parameters setting become convenient and simple.

Press “Fun” key so that the keypad controller will display function code. If press “▲” or “▼” key then, function code will circularly keep increasing or decreasing by degrees within the group; if press the “stop/reset” key again, function code will change circularly between two code groups when operating the “▲” or “▼” key.

e.g. when function code shows F111 and DGT indicator is on, press “▲”/ “▼” key, function code will keep increasing or decreasing by degrees within F100~F160; press “stop/reset” key again, DGT indicator will be off. When pressing “▲”/ “▼” key, function codes will change circularly among the 10 code-groups, like F211, F311...FA11, F111..., Refer to Fig 2-2 (The sparkling “50.00” is indicated the corresponding target frequency values).

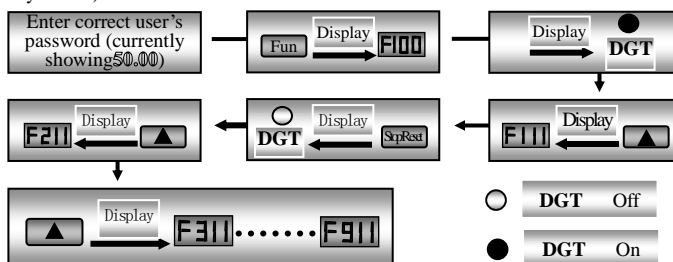

Fig 3-6 Switch over in a Code Group or between Different Code-Groups

3.6 Panel Display

Table 3-4 Items and Remarks Displayed on the Panel

Items	Remarks
Power on.... (Four-line LCD)	It stands for power on process.
HF-0	This Item will be displayed when you press “Fun” in stopping status, which indicates jogging operation is valid. But HF-0 will be displayed only after you change the value of F132.
-HF-	It stands for resetting process and will display target frequency after reset.
OC, OC1, OC2, OE, OL1, OL2, OH, LU, PF0, PF1, CE, PG, STO, STO1	Fault code, indicating “over-current OC”, “over-current OC1”, “over-current OC2”, “over-voltage”, “inverter over-load”, “motor over-load” “over-heat”, “under-voltage for input”, “phase loss for output”, “phase loss for input”, “communication error”, PG disconnection protection, STO and STO1 respectively.
AErr, EP, nP, Err5	Analog line disconnected, inverter under-load, pressure control, PID parameters are set wrong.
ovEr, br1, br2	(textile industry) yarn full, yarn broken, yarn intertwining.
ESP	During two-line/three line running mode, “stop/reset” key is pressed or external emergency stop terminal is closed, ESP will be displayed.

E2000

oPEn	When oPEn terminal is invalid, inverter will trip into oPEn protection.
F152	Function code (parameter code).
10.00	Indicating inverter's current running frequency (or rotate speed) and parameter setting values, etc.
50.00	Sparkling in stopping status to display target frequency.
A100, U100, u540	Output current (100A) and output voltage (100V) and bus voltage(540V).
b*.*	PID feedback value is displayed.
o*.*	PID given value is displayed.
L***	Linear speed is displayed.
H ***	Radiator temperature is displayed.

IV. Installation & Connection

4.1 Installation

Inverter should be installed vertically, as shown in Fig 4-1. Sufficient ventilation space should be ensured in its surrounding.

Clearance dimensions (recommended) are available from Table 4-1 for installing the inverter.

Table 4-1 Clearance Dimensions

Model	Clearance Dimensions	
Hanging (<55kW)	$A \geq 150\text{mm}$	$B \geq 100\text{mm}$
Hanging ($\geq 55\text{kW}$)	$A \geq 200\text{mm}$	$B \geq 100\text{mm}$
Cabinet (110~800kW)	$C \geq 200\text{mm}$	$D \geq 100\text{mm}$

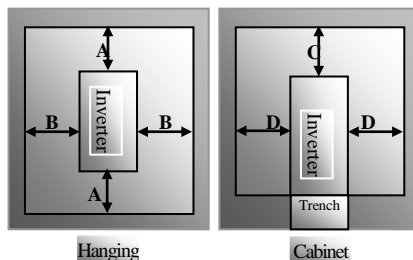
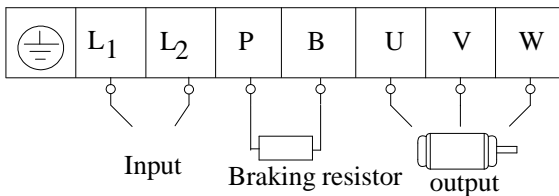

Fig 4-1 Installation Sketch

4.2 Connection

- In case of 3-phase input, connect R/L1, S/L2 and T/L3 terminals (L1/R and L2/S terminals for single-phase) with power source from network and PE/E to earthing, U, V and W terminals to motor.
- Motor shall have to be ground connected. Or else electrified motor causes interference.

Power terminals sketch of inverter with 1-phase 230V 1.5kW and below 1.5kW.



Power terminals sketch of inverter with 3-phase 230V 1.5kW and below 1.5kW.

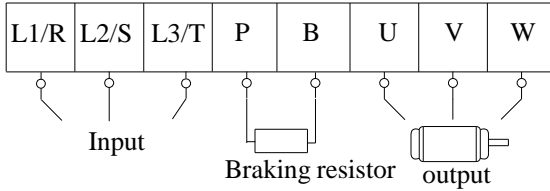

Power terminals sketch of inverter with 1-phase 230V 2.2kW, 3-phase 230V 2.2kW~5.5 kW, and 3-phase 400V 0.75kW~15kW.

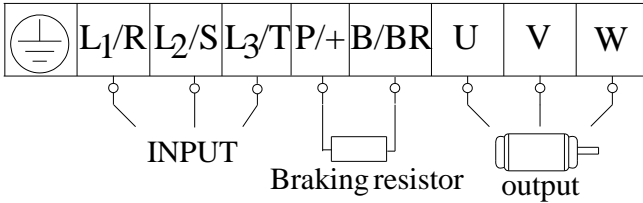

Power terminals sketch of inverter with 3-phase 230V 7.5~11kW and three-phase 400V 18.5kW~45kW.

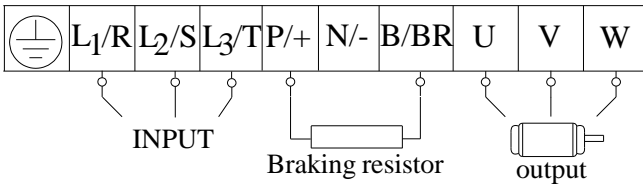

Power terminals sketch of inverter with 3-phase 230V 15~75kW and 3-phase 400V 55kW~185kW hanging type inverter and 110kW~160kW cabinet inverter.

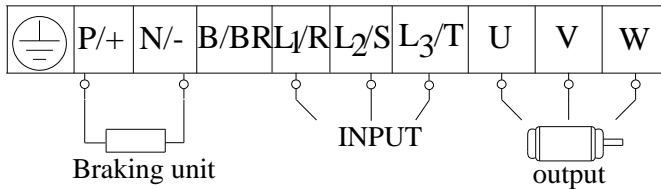

Power terminals sketch of inverter with 3-phase 200kw~400kw hanging type inverter and 185kw~800kw cabinet inverter.

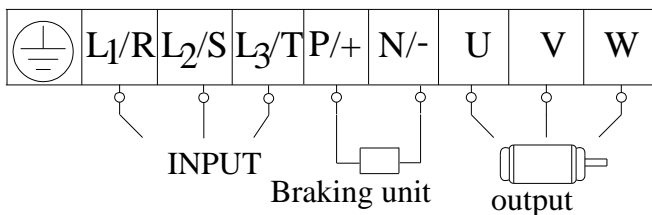

(The figure is only sketch, terminals order of practical products may be different from the above-mentioned figure.)

Introduction of terminals of power loop

Terminals	Terminal Marking	Terminal Function Description
Power Input Terminal	L1/R, L2/S, L3/T	Input terminals of three-phase 400V AC voltage (L1/R and L2/S terminals for 1-phase)
Output Terminal	U, V, W	Inverter power output terminal, connected to motor.
Grounding Terminal	PE/E/⊕	Inverter grounding terminal.
Rest Terminal	P/+, B/BR	External braking resistor.
	P/+, N/-	DC bus-line output Externally connected to braking unit P/+ connected to input terminal “P” or “DC+” of braking unit, N/- connected to input terminal of braking unit “N” or “DC-”.

4.3 Functions of control terminals

The key to operate the inverter is to operate the control terminals correctly and flexibly. Certainly, the control terminals are not operated separately, and they should match corresponding settings of parameters. This chapter describes basic functions of the control terminals. The users may operate the control terminals by combining relevant contents hereafter about “Defined Functions of the Terminals”.

Wiring for control loop as follows:

TA	TB	TC	DO1	DO2	24V	CM	DI1	DI2	DI3	DI4	DI5	DI6	DI7	DI8	10V	AI1	AI2	GND	AO1	AO2
GND	5V	A+	B-	H	L	GND														

Table 4-3

Functions of Control Terminals

Terminal	Type	Description	Function	
DO1	Output signal	Multifunctional output terminal 1	When the token function is valid, the value between this terminal and CM is 0V; when the inverter is stopped, the value is 24V. When DO1 is as high-frequency output terminal, the max output frequency is 100KHz and please do not connect to intermediate relay.	The functions of output terminals shall be defined per manufacturer’s value. Their initial state may be changed through changing function codes.
DO2 ^{Note 1}		Multifunctional output terminal 2	When the token function is valid, the value between this terminal and CM is 0V; when the inverter is stopped, the value is 24V.	
TA		Relay contact	TC is a common point, TB-TC are normally closed contacts, TA-TC are normally open contacts. The contact capacity is 10A/125VAC, NO/NC 3A 250VAC/30VDC.	
TB				
TC				
AO1		Voltage/current output	It is connected with frequency meter, speedometer or ammeter externally, and its minus pole is connected with GND. See F423~F426 for details,.	
AO2	Current output	It is connected with ammeter externally, and its minus pole is connected with GND. See F427~F430 for details		
10V	Analog power supply	Self contained power supply	Internal 10V self-contained power supply of the inverter provides power to the inverter. When used externally, it can only be used as the power supply for voltage control signal, with current restricted below 20mA.	
AI1 ^{Note 2}	Input Signal	Voltage analog input port	When analog speed control is adopted, the voltage or current signal is input through this terminal. The range of voltage input is 0~5V or 0~10V or -10V-10V, and the current input is 0~20mA, the input resistor is 500Ohm, and grounding: GND. If the input is 4~20mA, it can be realized by setting F406=2. The voltage or current signal can be chosen by coding switch. See table 5-2, 5-3 for details, and F438 and F439 also should be set accordingly. The default setting of AI1 is 0~10V, and the default setting of AI2 is 0~20mA.	
AI2		Voltage / Current analog input port		
GND		Self-contained Power supply Ground	Ground terminal of external control signal (voltage control signal or current source control signal) is also the ground of 10V power supply of this inverter.	

24V	Power supply	Control power supply	Power: $24 \pm 1.5V$, grounding is CM; current is restricted below 200mA for external use.
DI1	Digital input control terminal	Jogging terminal	When this terminal is valid, the inverter will have jogging running. The jogging function of this terminal is valid under both at stopped and running status. This terminal can also be used as high-speed pulse input port. The max frequency is 100KHz.
DI2		External Emergency Stop	When this terminal is valid, "ESP" malfunction signal will be displayed.
DI3		"FWD" Terminal	When this terminal is valid, inverter will run forward.
DI4		"REV" Terminal	When this terminal is valid, inverter will run reversely.
DI5		Reset terminal	Make this terminal valid under fault status to reset the inverter.
DI6		Free-stop	Make this terminal valid during running can realize free stop.
DI7 <small>Note 1</small>		Running terminal	When this terminal is in the valid state, inverter will run by the acceleration time.
DI8 <small>Note 1</small>		Stop terminal	Make this terminal valid during running can realize stop by the deceleration time.
CM	Common port	Grounding of control power supply	The grounding of 24V power supply and other control signals.
GND	485 communication terminals	Grounding of differential signal	Grounding of differential signal
5V		Power of differential signal	Power of differential signal
A+		Positive polarity of differential signal	Standard: TIA/EIA-485(RS-485) Communication protocol: Modbus
B-		Negative polarity of Differential signal	Communication rate: 1200/2400/4800/9600/19200/38400/57600bps
GND	CAN communication	CAN cable shielded layer	CAN cable's shielded layber
H		CAN H high-level cable	Can baud rate: 20/50/100/125/250/500/1000kbps
L		CAN L low-level cable	

Note:

- T3 30kW and below 30kW and T2 11kw and below 11kw inverters have no DO2, DI7 and DI8 control terminals.
- All terminal of T3 30kW and below 30kW and T2 11kw and below 11kw inverters can only accept

voltage signal, the default voltage is 0~10V.

3. CAN communication terminal is available from frame size E2. E2-E6 has H and L terminals, E7 and above has GND/H/L terminals. GND terminal must be connected between inverters. Communication cable must be shielded twisted cable. J11 of inverters on the head end and terminal end of bus turns to ON. J11 of the other inverters turn to OFF.

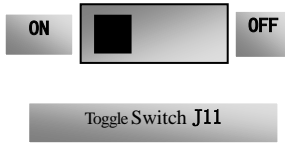

Wiring for digital input terminals:

Generally, shield cable is adopted and wiring distance should be as short as possible. When active signal is adopted, it is necessary to take filter measures to prevent power supply interference. Mode of contact control is recommended.

Digital input terminals are only connected by source electrode (NPN mode) or by drain electrode (PNP mode). If NPN mode is adopted, please turn the toggle switch to the end of "NPN".

Wiring for control terminals as follows:

1. Wiring for positive source electrode (NPN mode).

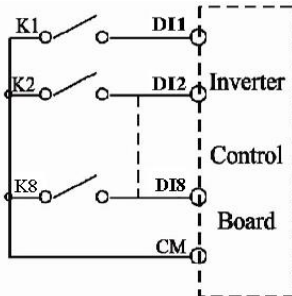

2. Wiring for active source electrode

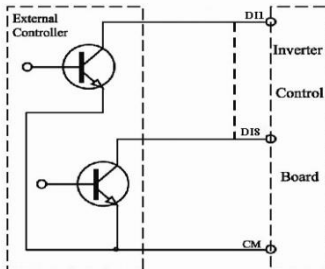

If digital input control terminals are connected by drain electrode, please turn the toggle switch to the end of “PNP”. Wiring for control terminals as follows:

3. Wiring for positive drain electrode (PNP mode)

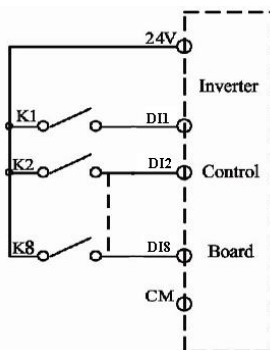

4. Wiring for active drain electrode (PNP mode)

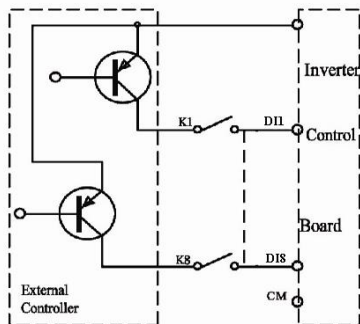

Wiring by source electrode is a mode most in use at present. Wiring for control terminal is connected by source electrode, user should choose wiring mode according to requirement.

Instructions of choosing NPN mode or PNP mode:

1. There is a toggle switch J7 near to control terminals. Please refer to Fig 3-2.
2. When turning J7 to “NPN”, DI terminal is connected to CM. When turning J7 to “PNP”, DI terminal is connected to 24V.



Fig 4-2 Toggle Switch J7

4.4 Measurement of main circuit voltages, currents and powers

Since the voltages and currents on the inverter power supply and output sides include harmonics, measurement data depends on the instruments used and circuits measured. When instruments for commercial frequency are used for measurement, measure the following circuits with the recommended instruments.

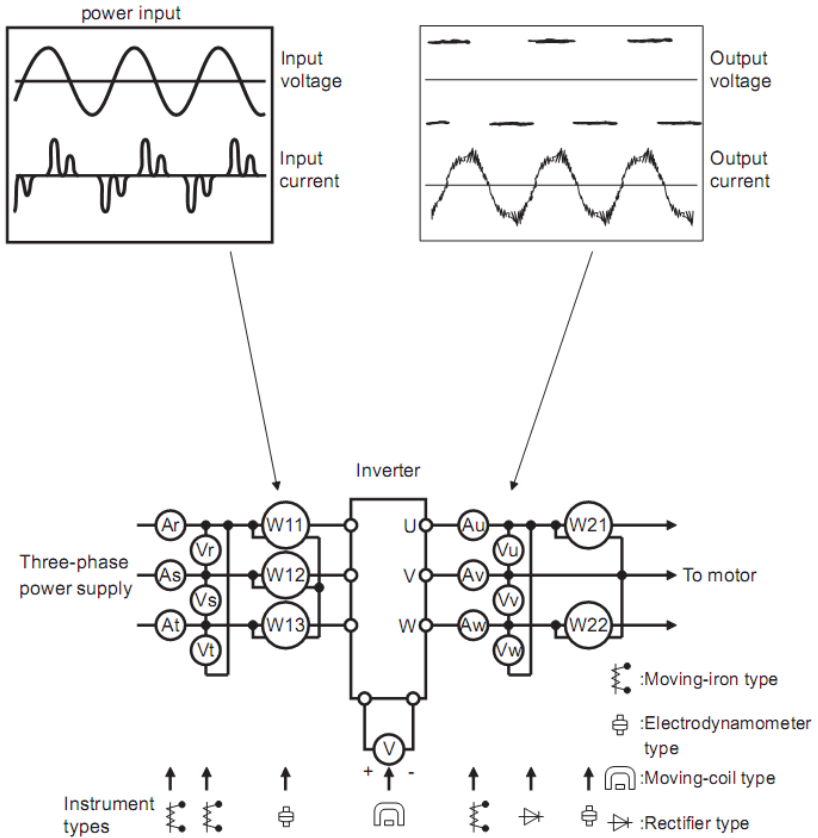

Examples of Measuring Points and Instruments

Item	Measuring Point	Measuring Instrument	Remarks (Reference Measurement Value)
Power supply voltage V1	Across R-S,S-T, T-R	Moving-iron type AC voltmeter	400V±5% , 230V±5%
Power supply side current I1	R, S, and T line currents	Moving-iron type AC voltmeter	
Power supply side power P1	At R, S and T, and across R-S, S-T and T-R	Electrodynamic type single-phase wattmeter	P1=W11+W12+W13 (3-wattmeter method)
Power supply side power factor Pf1	Calculate after measuring power supply voltage, power supply side current and power supply side power.[Three phase power supply] $Pf1 = \frac{P1}{\sqrt{3}V1 \times I1} \times 100\%$		
Output side voltage V2	Across U-V, V-W and W-U	Rectifier type AC voltmeter (Moving-iron type cannot measure)	Difference between the phases is within ±1% of the maximum output voltage.
Output side current I2	U, V and W line currents	Moving-iron type AC Ammeter	Current should be equal to or less than rated inverter current. Difference between the phases is 10% or lower of the rated inverter current.
Output side power P2	U, V, W and U-V, V-W,W-U	Electrodynamic type single-phase wattmeter	P2 = W21 + W22 2-wattmeter method
Output side power factor Pf2	Calculate in similar manner to power supply side power factor: $Pf2 = \frac{P2}{\sqrt{3}V2 \times I2} \times 100\%$		
Converter output	Across P+ (P) and -(N)	Moving-coil type (such as multi-meter)	DC voltage, the value is $\sqrt{2} \times V1$
Power supply of control PCB	Across 10V-GND	Moving-coil type (such as multi-meter)	DC10V±0.2V
	Across 24V-CM	Moving-coil type (such as multi-meter)	DC24V±1.5V
Analog output AO1	Across AO1-GND	Moving-coil type (such as multi-meter)	Approx. DC10V at max frequency.
	Across AO2-GND	Moving-coil type (such as multi-meter)	Approx. DC 0~20mA at max frequency
Alarm signal	Across TA/TC Across TB/TC	Moving-coil type (such as multi-meter)	<Normal> <Abnormal> Across TA/TC: Discontinuity Continuity Across TB/TC: Continuity Discontinuity

4.5 Wiring Recommended

Inverter Model	LeadSectionArea(mm ²)	Inverter Model	LeadSectionArea(mm ²)
E2000-0004S2	1.5	E2000-0075T3	4.0
E2000-0007S2	2.5	E2000-0110T3	6.0
E2000-0015S2	2.5	E2000-0150T3	10
E2000-0022S2	4.0	E2000-0185T3	16
E2000-0002T2	1.5	E2000-0220T3	16
E2000-0004T2	1.5	E2000-0300T3	25
E2000-0007T2	2.5	E2000-0370T3	25
E2000-0015T2	2.5	E2000-0450T3	35
E2000-0022T2	4.0	E2000-0550T3	35
E2000-0030T2	4.0	E2000-0750T3	50
E2000-0040T2	4.0	E2000-0900T3	70
E2000-0055T2	6.0	E2000-1100T3	70
E2000-0075T2	10	E2000-1320T3	95
E2000-0110T2	16	E2000-1600T3	120
E2000-0150T2	25	E2000-1850T3	120
E2000-0185T2	25	E2000-2000T3	150
E2000-0220T2	25	E2000-2200T3	185
E2000-0300T2	35	E2000-2500T3	240
E2000-0370T2	50	E2000-2800T3	240
E2000-0450T2	50	E2000-3150T3	300
E2000-0550T2	70	E2000-3550T3	300
E2000-0750T2	95	E2000-4000T3	400
E2000-0007T3	1.5	E2000-4500T3	480
E2000-0015T3	2.5	E2000-5000T3	520
E2000-0022T3	2.5	E2000-5600T3	560
E2000-0030T3	2.5	E2000-6300T3	720
E2000-0040T3	2.5	E2000-7100T3	780
E2000-0055T3	4.0	E2000-8000T3	900

Table 4-6 recommended stripping length

Model	Power cable		Grounding cable	
	Cable fixing mode	Stripping length(mm)	Cable fixing mode	Stripping length (mm)
E2000-0004S2	Line pressing	7.0	Line pressing	7.0
E2000-0007S2	Line pressing	7.0	Line pressing	7.0
E2000-0015S2	Line pressing	7.0	Line pressing	7.0
E2000-0022S2	Line pressing	8.0	Line pressing	8.0
E2000-0002T2	Line pressing	7.0	Line pressing	7.0
E2000-0004T2	Line pressing	7.0	Line pressing	7.0
E2000-0007T2	Line pressing	7.0	Line pressing	7.0
E2000-0015T2	Line pressing	7.0	Line pressing	7.0
E2000-0022T2	Line pressing	8.0	Line pressing	8.0
E2000-0030T2	Line pressing	8.0	Line pressing	8.0
E2000-0040T2	Line pressing	10.0	Line pressing	10.0
E2000-0055T2	Line pressing	10.5	Line pressing	10.5
E2000-0075T2	Line pressing	16.5	Line pressing	16.5
E2000-0110T2	Line pressing	16.5	Line pressing	16.5
E2000-0007T3	Line pressing	7.0	Line pressing	7.0
E2000-0015T3	Line pressing	7.0	Line pressing	7.0
E2000-0022T3	Line pressing	8.0	Line pressing	8.0
E2000-0030T3	Line pressing	8.0	Line pressing	8.0
E2000-0040T3	Line pressing	8.0	Line pressing	8.0
E2000-0055T3	Line pressing	10.0	Line pressing	10.0
E2000-0075T3	Line pressing	10.0	Line pressing	10.0
E2000-0110T3	Line pressing	10.5	Line pressing	10.5
E2000-0150T3	Line pressing	10.5	Line pressing	10.5
E2000-0185T3	Line pressing	16.5	Line pressing	16.5
E2000-0220T3	Line pressing	16.5	Line pressing	16.5
E2000-0300T3	Line pressing	16.5	Line pressing	16.5

Model	Power cable		Grounding cable	
	Terminal screw	Tube cable lug	Terminal screw	Tube cable lug
E2000-0150T2	M6	GTNR25-6	M6	GTNR16-6
E2000-0185T2	M6	GTNR25-6	M6	GTNR16-6
E2000-0220T2	M6	GTNR16-6	M6	GTNR16-6
E2000-0300T2	M8	GTNR35-8	M8	GTNR35-8
E2000-0370T2	M8	GTNR35-8	M6	GTNR16-6
E2000-0450T2	M8	GTNR50-8	M6	GTNR25-6
E2000-0550T2	M10	GTNR70-10	M8	GTNR35-8
E2000-0750T2	M10	SC120-12	M10	GTNR70-10
E2000-0370T3	M8	GTNR25-6	M6	GTNR16-6
E2000-0450T3	M8	GTNR35-8	M6	GTNR16-6
E2000-0550T3	M8	GTNR35-8	M6	GTNR16-6
E2000-0750T3	M8	GTNR50-8	M6	GTNR25-6
E2000-0900T3	M10	GTNR70-10	M8	GTNR35-8
E2000-1100T3	M10	GTNR70-10	M8	GTNR35-8
E2000-1320T3	M10	GTNR95-10	M8	GTNR50-8
E2000-1600T3	M10	SC120-12	M10	GTNR70-10
E2000-1850T3	M12	GTNR120-12	M10	GTNR70-10
E2000-2000T3	M12	GTNR150-12	M10	GTNR95-10
E2000-2200T3	M12	GTNR185-16	M10	GTNR95-10
E2000-2500T3	M12	GTNR240-16	M12	GTNR120-12
E2000-2800T3	M12	GTNR240-16	M12	GTNR120-12
E2000-3150T3	M16	GTNR150-16	M12	GTNR150-12
E2000-3550T3	M16	GTNR150-16	M12	GTNR150-12
E2000-4000T3	M16	GTNR240-16	M16	GTNR240-16
E2000-4500T3	M16	GTNR240-16	M16	GTNR240-16

4.6 Lead section area of protect conductor (grounding wire)

Lead section area S of U, V, W (mm ²)	Min lead section area of $\frac{\oplus}{\ominus} / I_{th}$ /PE/E(mm ²)
S ≤ 16	S
16 < S ≤ 35	16
35 < S	S/2

4.7 Overall Connection and “Three- Line” Connection

* Refer to next figure for overall connection sketch for E2000 series inverters. Wiring mode is available for various terminals whereas not every terminal needs connection when applied.

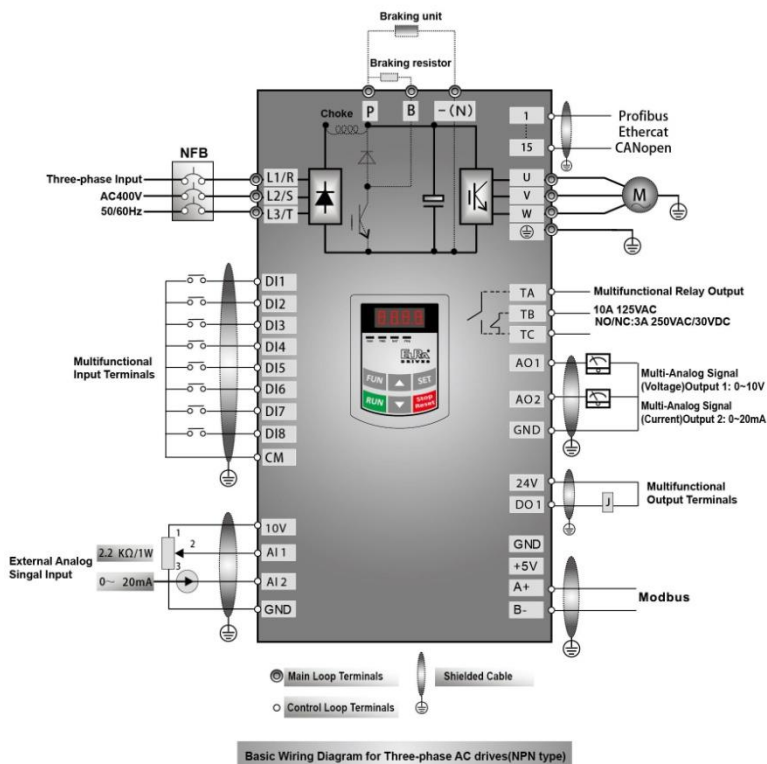

Note:

1. Please only connect power terminals L1/R and L2/S with power grid for single-phase inverters.
2. 485 communication port has built-in standard MODBUS communication protocol. Communication port is on the left side of inverter. The sequence from top to down is B-, A+, 5V power, and GND.
3. Inverter above 30kW has 8 multifunctional input terminals DI1~DI8, 30kW inverter and below 30kW has 6 multifunctional input terminals DI1~DI6.
4. The contact capacity is 10A/125VAC. NO/NC: 3A 250VAC/30VDC.

4.8 Basic methods of suppressing the noise

The noise generated by the drive may disturb the equipment nearby. The degree of disturbance is dependent on the drive system, immunity of the equipment, wiring, installation clearance and earthing methods.

4.8.1 Noise propagation paths and suppressing methods

① Noise categories

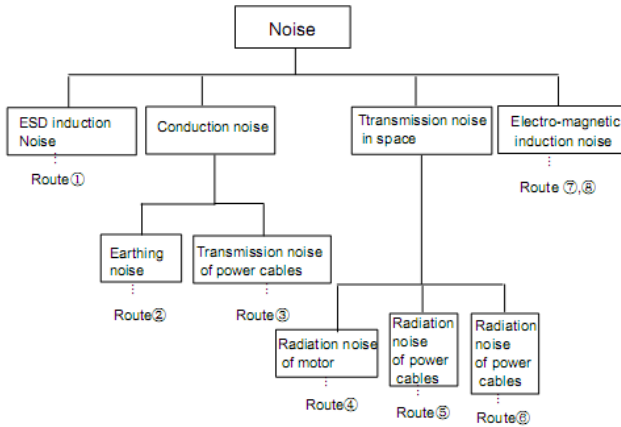

② Noise propagation paths

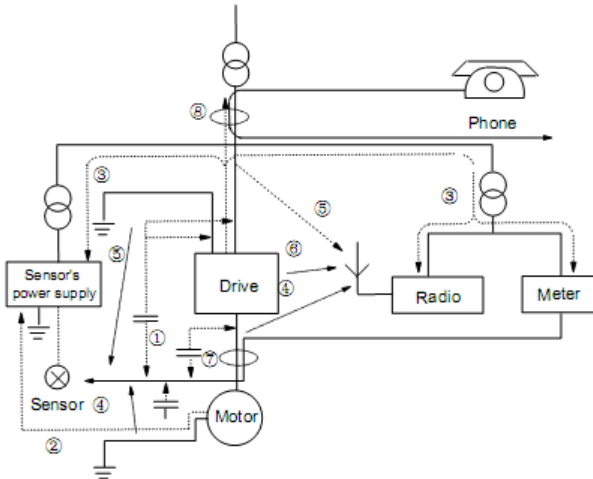

③ Basic methods of suppressing the noise

Noise emission paths	Actions to reduce the noise
②	When the external equipment forms a loop with the drive, the equipment may suffer nuisance tripping due to the drive's earth leakage current. The problem can be solved if the equipment is not grounded.
③	If the external equipment shares the same AC supply with the drive, the drive's noise may be transmitted along its input power supply cables, which may cause nuisance tripping to other external equipment. Take the following actions to solve this problem: Install noise filter at the input side of the drive, and use an isolation transformer or line filter to prevent the noise from disturbing the external equipment.
④⑤⑥	If the signal cables of measuring meters, radio equipment and sensors are installed in a cabinet together with the drive, these equipment cables will be easily disturbed. Take the actions below to solve the problem: (1) The equipment and the signal cables should be as far away as possible from the drive. The signal cables should be shielded and the shielding layer should be grounded. The signal cables should be placed inside a metal tube and should be located as far away as possible from the input/output cables of the drive. If the signal cables must cross over the power cables, they should be placed at right angle to one another. (2) Install radio noise filter and linear noise filter (ferrite common-mode choke) at the input and output of the drive to suppress the emission noise of power lines. (3) Motor cables should be placed in a tube thicker than 2mm or buried in a cement conduit. Power cables should be placed inside a metal tube and be grounded by shielding layer
①⑦⑧	Don't route the signal cables in parallel with the power cables or bundle these cables together because the induced electro-magnetic noise and induced ESD noise may disturb the signal cables. Other equipment should also be located as far away as possible from the drive. The signal cables should be placed inside a metal tube and should be placed as far away as possible from the input/output cables of the drive. The signal cables and power cables should be shielded cables. EMC interference will be further reduced if they could be placed inside metal tubes. The clearance between the metal tubes should be at least 20cm.

4.8.2 Field Wire Connections

Control cables, input power cables and motor cables should be installed separately, and enough clearance should be left among the cables, especially when the cables are laid in parallel and the cable length is big. If the signal cables must go through the power cables, they should be vertical to each other.

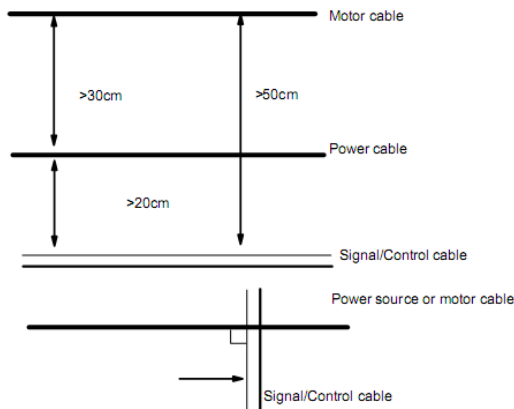

Generally, the control cables should be shielded cables and the shielding metal net must be connected to the metal enclosure of the drive by cable clamps.

4.8.3 Earthing

Independent earthing poles (best)

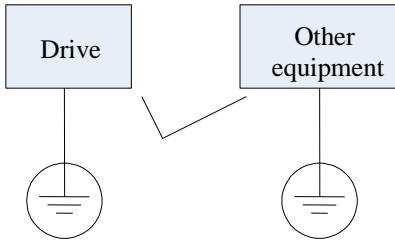

Shared earthing pole (good)

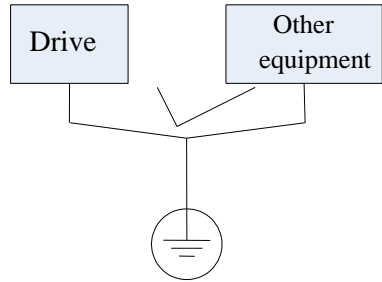

Shared earthing cable (not good)

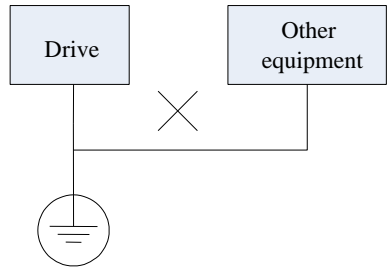
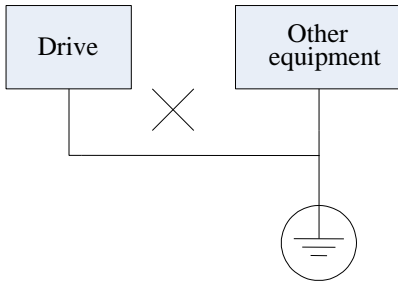

Note:

1. In order to reduce the earthing resistance, flat cable should be used because the high frequency impedance of flat cable is smaller than that of round cable with the same CSA.
2. If the earthing poles of different equipment in one system are connected together, then the leakage current will be a noise source that may disturb the whole system. Therefore, the drive's earthing pole should be separated with the earthing pole of other equipment such as audio equipment, sensors and PC, etc.
3. Earthing cables should be as far away from the I/O cables of the equipment that is sensitive to noise, and also should be as short as possible.

4.8.4 Leakage current

Leakage current may flow through the drive's input and output capacitors and the motor's capacitor. The leakage current value is dependent on the distributed capacitance and carrier wave frequency. The leakage current includes ground leakage current and the leakage current between lines.

Ground leakage current

The ground leakage current can not only flow into the drive system, but also other equipment via earthing cables. It may cause the leakage current circuit breaker and relays falsely activated. The higher the drive's carrier wave frequency, the bigger the leakage current, also, the longer the motor cable, the greater the leakage current,

Suppressing methods:

Reduce the carrier wave frequency, but the motor noise may be louder;

Motor cables should be as short as possible;

The drive and other equipment should use leakage current circuit breaker designed for protecting the product against high-order harmonics/surge leakage current;

Leakage current between lines

The line leakage current flowing through the distribution capacitors of the drive out side may cause the thermal relay falsely activated, especially for the drive whose power is lower than 7.5kW. When the cable is longer than 50m, the ratio of leakage current to motor rated current may be increased that can cause the wrong action of external thermal relay very easily.

Suppressing methods:

Reduce the carrier wave frequency, but the motor noise may become louder;

Install reactor at the output side of the drive.

In order to protect the motor reliably, it is recommended to use a temperature sensor to detect the motor's temperature, and use the drive's over-load protection device (electronic thermal relay) instead of an external thermal relay.

4.8.5 Electrical installation of the drive

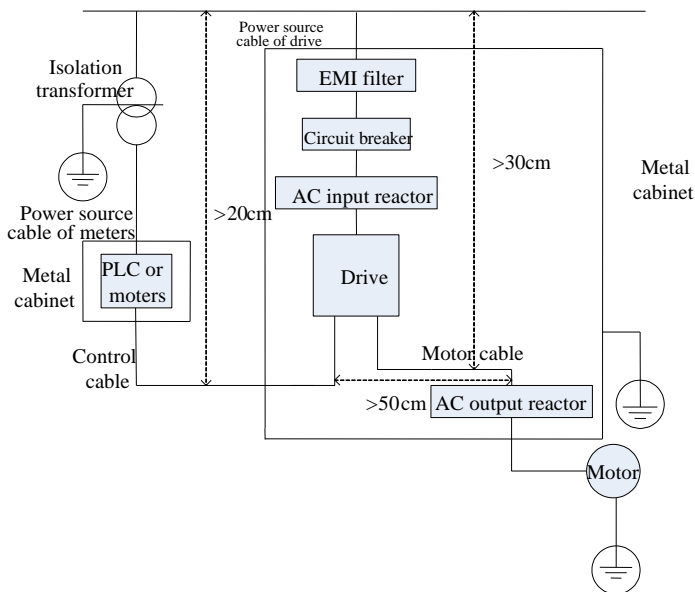

Note:

Motor cable should be earthed at the drive side, if possible, the motor and drive should be earthed separately;

Motor cable and control cable should be shielded . The shield must be earthed and avoid entangling at cable end to improve high frequency noise immunity.

Assure good conductivity among plates, screw and metal case of the drive; use tooth-shape washer and conductive installation plate;

4.8.6 Application of Power Line Filter

Power source filter should be used in the equipment that may generate strong EMI or the equipment that is sensitive to the external EMI. The power source filter should be a two-way low pass filter through which only 50Hz current can flow and high frequency current should be rejected.

Function of power line filter

The power line filter ensures the equipment can satisfy the conducting emission and conducting sensitivity in EMC standard. It can also suppress the radiation of the equipment.

Common mistakes in using power cable filter

1. Too long power cable

The filter inside the cabinet should be located near to the input power source. The length of the power cables should be as short as possible.

2. The input and output cables of the AC supply filter are too close

The distance between input and output cables of the filter should be as far apart as possible, otherwise the high frequency noise may be coupled between the cables and bypass the filter. Thus, the filter will become ineffective.

3. Bad earthing of filter

The filter's enclosure must be earthed properly to the metal case of the drive. In order to be earthed well, make use of a special earthing terminal on the filter's enclosure. If you use one cable to connect the filter to the case, the earthing is useless for high frequency interference. When the frequency is high, so is the impedance of cable, hence there is little bypass effect. The filter should be mounted on the enclosure of equipment. Ensure to clear away the insulation paint between the filter case and the enclosure for good earthing contact.

4.8.7 Jumper for switching off safety capacitor

The default position of jumper J1 for safety capacitor is ENABLE. If the earth leakage circuit breaker is active during powering on, please change the position of J1 to DISABLE.

On power PCB, the default position of J1 is Pin 1 and 3, which is for EMC interference. If the earth leakage circuit breaker is active during powering on, please plug the J1 with Pin 2 and 4.

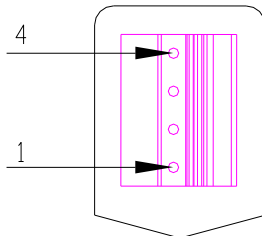

V. Operation and Simple Running

This chapter defines and interprets the terms and nouns describing the control, running and status of the inverter. Please read it carefully. It will be helpful to your correct operation.

5.1 Basic conception

5.1.1 Control mode

E2000 inverter has five control modes: sensorless vector control (F106=0), closed-loop vector control (F106=1), V/F control (F106=2) and vector control 1 (F106=3), PMSM vector control (F106=6).

5.1.2 Mode of torque compensation

Under V/F control mode, E2000 inverter has five kinds of torque compensation modes: Linear compensation (F137=0); Square compensation (F137=1); User-defined multipoint compensation (F137=2); Auto torque compensation (F137=3); VF separation (F137=4).

5.1.3 Mode of frequency setting

Please refer to F203~F207 for the method for setting the running frequency of the E2000 inverter.

5.1.4 Mode of controlling for running command

The channel for inverter to receive control commands (including start, stop and jogging, etc) contains three modes: 1. Keypad (keypad panel) control; 2. External terminal control; 3. Communication control. The modes of control command can be selected through the function codes F200 and F201.

5.1.5 Operating status of inverter

When the inverter is powered on, it may have four kinds of operating status: stopped status, programming status, running status, and fault alarm status. They are described in the following:

Stopped status

If re-energize the inverter (if “auto-startup after being powered on” is not set) or decelerate the inverter to stop, the inverter is at the stopping status until receiving control command. At this moment, the running status indicator on the keypad goes off, and the display shows the display status before power down.

Programming status

Through keypad panel, the inverter can be switched to the status that can read or change the function code parameters. Such a status is the programming status.

There are numbers of function parameters in the inverter. By changing these parameters, the user can realize different control modes.

Running status

The inverter at the stopped status or fault-free status will enter running status after having received operation command.

The running indicator on keypad panel lights up under normal running status.

Fault alarm status

The status under which the inverter has a fault and the fault code is displayed.

Fault codes mainly include: OC, OE, OL1, OL2, OH, LU, PF1 and PF0 representing “over current”, “over voltage”, “inverter overload”, “motor overload”, “overheat”, “input under-voltage”, “input phase loss”, and “output phase loss” respectively.

For trouble shooting, please refer to Appendix I to this manual, “Trouble Shooting”.

5.2 Keypad panel and operation method

Keypad panel (keypad) is a standard part for configuration of E2000 inverter. Through keypad panel, the user may carry out parameter setting, status monitoring and operation control over the inverter. Both keypad panel and display screen are arranged on the keypad controller, which mainly consists of three sections: data display section, status indicating section, and keypad operating section. There are two types of keypad controller (LED and four-line LCD) for inverter. For details, please refer to Chapter II of this manual, “Keypad panel”.

It is necessary to know the functions and how to use the keypad panel. Please read this manual carefully before operation.

5.2.1 Method of operating the keypad panel

(1) Operation process of setting the parameters through keypad panel



A three-level menu structure is adopted for setting the parameters through keypad panel of inverter, which enables convenient and quick searching and changing of function code parameters.

Three-level menu: Function code group (first-level menu) → Function code (second-level menu) → Set value of each function code (third-level menu).



(2) Setting the parameters

Setting the parameters correctly is a precondition to give full play of inverter performance. The following is the introduction on how to set the parameters through keypad panel.

LED keypad operating procedures:

- ① Press the “Fun” key, to enter programming menu.
- ② Press the key “Stop/Reset” or , the DGT lamp goes out. Press ▲ and ▼, the function code will change within the function code group. The first number behind F displayed on the panel is 1, in other words, it displays F1 ××at this moment.
- ③ Press the key “Stop/Reset” or , again, the DGT lamp lights up, and the function code will change within the code group. Press ▲ and ▼ to change the function code to F113; press the “Set” key to display 50.00; while press ▲ and ▼ to change to the need frequency.
- ④ Press the “Set” key to complete the change.

The operation of four-line LCD:

When function code shows F100 and the last “0” in F100 is flashing, after pressing  key, the middle “0” is flashing, then press  again, “1” in F100 is flashing, the flashing value can be changed by pressing “▲”/“▼” key.

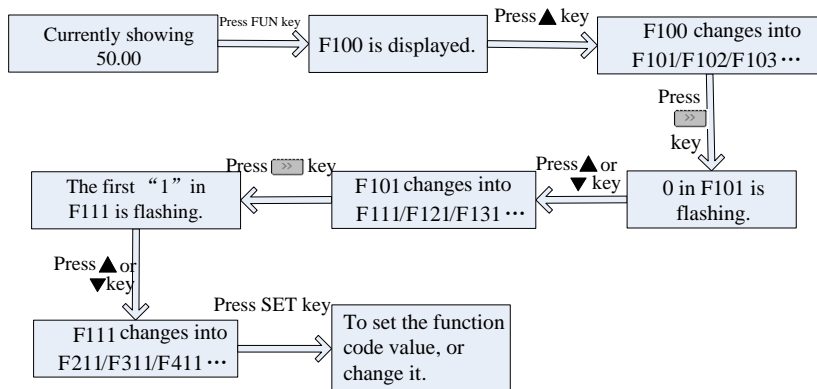

Fig 5-1 Switch over in a Code Group or between Different Code-Groups

Operating instructions of 4-line LCD interface switch

① Operating instructions of SET/FUN keys

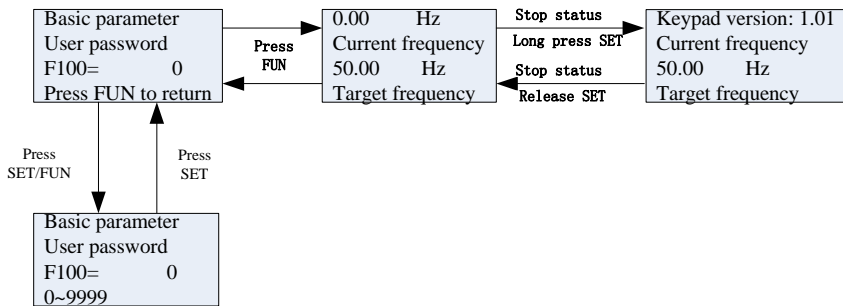

Fig 5-2 Operating flow chart of interface switch

② Operating instructions of multifunction key

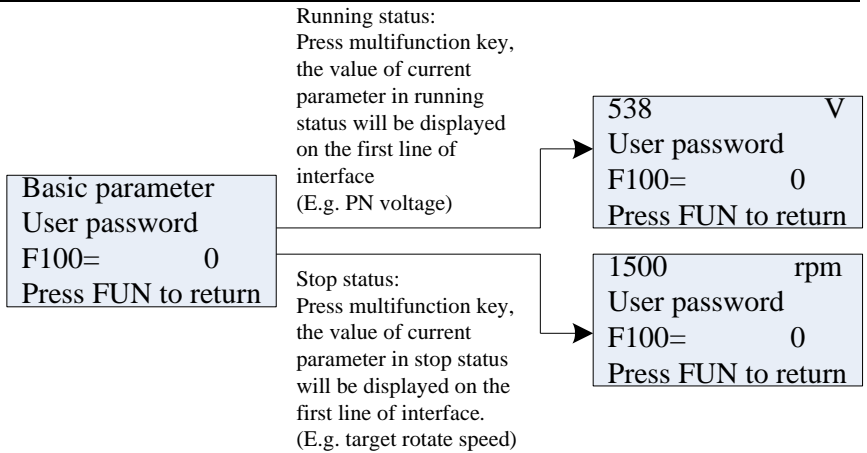

Fig 5-3 Operating flow chart of programming

③ Operating instructions of inverter status display

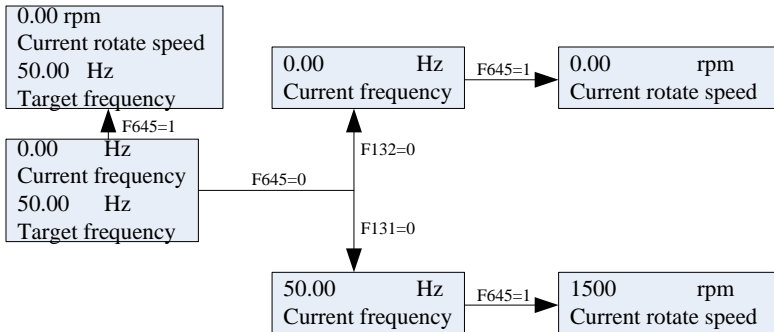

Fig 5-4 Operating flow chart of status parameter display

④ Regulating target frequency/target rotate speed by UP/DOWN keys in running status

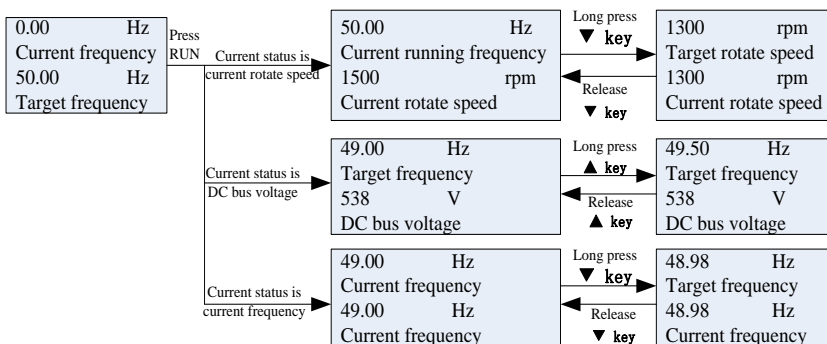

Fig 5-5 Operating flow chart of target frequency/rotate speed adjustments

⑤ Operating instructions of displayed malfunction interface

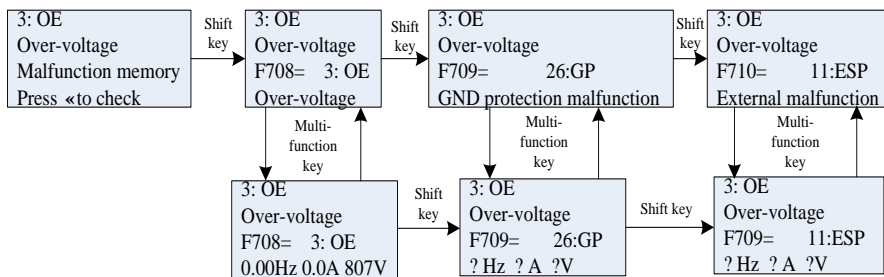

Fig 5-6 Operating flow chart of displayed malfunction interface

5.2.2 Switching and displaying of status parameters

Under stopped status or running status, LED digitron and four-line LCD of inverter can display status parameters of the inverter. Actual parameters displayed can be selected and set through function codes F131 and F132. Through the “Fun” key, it can switch over repeatedly and display the parameters of stopped status or running status. The followings are the description of operation method of displaying the parameters under stopped status and running status.

(1) Switching of the parameters displayed under stopped status

Under stopped status, inverter has several parameters of stopped status, which can be switched over repeatedly and displayed with the keys “Fun” and “Stop/Reset”. These parameters are displayed: keypad jogging, target rotary speed, PN voltage, PID feedback value, temperature, PID given value and count value. Please refer to the description of function code F132.

(2) Switching of the parameters displayed under running status

Under running status, several parameters of running status can be switched over repeatedly and displayed with the keys “Fun”. These parameters are displayed: output rotary speed, output current, output voltage, PN voltage, PID feedback value, temperature, count value, linear speed and PID given value. Please refer to the description of function code F131.

5.2.3 Operation process of measuring motor parameters

The user shall input the parameters accurately as indicated on the nameplate of the motor prior to selecting operation mode of vector control and auto torque compensation (F137=3) of V/F control mode. Inverter will match standard motor stator resistance parameters according to these parameters indicated on the nameplate. To achieve better control performance, the user may start the inverter to measure the motor stator resistance parameters, so as to obtain accurate parameters of the motor controlled.

The motor parameters can be tuned through function code F800.

For example: If the parameters indicated on the nameplate of the motor controlled are as follows: numbers of motor poles are 4; rated power is 7.5kW; rated voltage is 400V; rated current is 15.4A; rated frequency is 50.00HZ; and rated rotary speed is 1440rpm, operation process of measuring the parameters shall be done as described in the following:

1. In accordance with the above motor parameters, set the values of F801 to F805 correctly: set the value of F801 = 7.5, F802 = 400, F803 = 15.4, F804 = 4 and F805 = 1440 respectively.
2. In order to ensure dynamic control performance of the inverter, set F800=1, i.e. select rotating tuning. Make sure that the motor is disconnected from the load. Press the “Run” key on the keypad, and the LED keypad will display “TEST”, four-line of LCD will display “parameters measurement...” and it will tune the motor’s parameters of two stages. After that, the motor will accelerate according to the acceleration time set at F114 and maintain for a certain period. The speed of motor will then decelerate to 0 according to the time set at F115. After auto-checking is completed, relevant parameters of the motor will be stored in function codes F806~F809, and F800 will turn to 0 automatically. In closed-loop vector control mode, please set F851 according to encoder, the unit is P/R.
3. If it is impossible to disconnect the motor from the load, select F800=2, i.e. stationary tuning. Press the “Run” key, the LED keypad will display “TEST”, four-line of LCD will display “parameters measurement...” and it will tune the motor’s parameters of two stages. The motor’s stator resistance, rotor resistance and leakage inductance will be stored in F806-F808 automatically, and F800 will turn to 0 automatically. The user may also calculate and input the motor’s mutual inductance value manually according to actual conditions of the motor.

5.2.4 Operation process of simple running

Table 5-1 Brief Introduction to Inverter Operation Process

Process	Operation	Reference
Installation and operation environment	Install the inverter at a location meeting the technical specifications and requirements of the product. Mainly take into consideration the environment conditions (temperature, humidity, etc) and heat radiation of the inverter, to check whether they can satisfy the requirements.	See Chapters I, II, III, IV.
Wiring of the inverter	Wiring of input and output terminals of the main circuit; wiring of grounding; wiring of switching value control terminal, analog terminal and communication interface, etc.	See Chapter IV.

Checking before getting energized	Make sure that the voltage of input power supply is correct; the input power supply loop is connected with a breaker; the inverter has been grounded correctly and reliably; the power cable is connected to the power supply input terminals of inverter correctly (R/L1, S/L2 terminals for single-phase power grid, and R/L1, S/L2, and T/L3 for three-phase power grid); the output terminals U, V, and W of the inverter are connected to the motor correctly; the wiring of control terminals is correct; all the external switches are preset correctly; and the motor is under no load (the mechanical load is disconnected from the motor).	See Chapters I~IV
Checking immediately after energized	Check if there is any abnormal sound, fuming or foreign flavor with the inverter. Make sure that the display of keypad panel is normal, without any fault alarm message. In case of any abnormality, switch off the power supply immediately.	See Appendix 1 and Appendix 2.
Inputting the parameters indicated on the motor's nameplate correctly, and measuring the motor's parameters.	Make sure to input the parameters indicated on the motor nameplate correctly, and study the parameters of the motor. The users shall check carefully, otherwise, serious problems may arise during running. Before initial running with vector control mode, carry out tuning of motor parameters, to obtain accurate electric parameters of the motor controlled. Before carrying out tuning of the parameters, make sure to disconnect the motor from mechanical load, to make the motor under entirely no load status. It is prohibited to measure the parameters when the motor is at a running status.	See description of parameter group F800~F830
Setting running control parameters	Set the parameters of the inverter and the motor correctly, which mainly include target frequency, upper and lower frequency limits, acceleration/deceleration time, and direction control command, etc. The user can select corresponding running control mode according to actual applications.	See description of parameter group.
Checking under no load	With the motor under no load, start the inverter with the keypad or control terminal. Check and confirm running status of the drive system. Motor's status: stable running, normal running, correct rotary direction, normal acceleration/deceleration process, free from abnormal vibration, abnormal noise and foreign flavor. Inverter's status: normal display of the data on keypad panel, normal running of the fan, normal acting sequence of the relay, free from the abnormalities like vibration or noise. In case of any abnormality, stop and check the inverter immediately.	See Chapter V.
Checking under with load	After successful test run under no load, connect the load of drive system properly. Start the inverter with the keypad or control terminal, and increase the load gradually. When the load is increased to 50% and 100%, keep the inverter run for a period respectively, to check if the system is running normally. Carry out overall inspection over the inverter during running, to check if there is any abnormality. In case of any abnormality, stop and check the inverter immediately.	

Checking during running	Check if the motor is running stably, if the rotary direction of the motor is correct, if there is any abnormal vibration or noise when the motor is running, if the acceleration/deceleration process of the motor is stable, if the output status of the inverter and the display of keypad panel is correct, if the blower fan is run normally, and if there is any abnormal vibration or noise. In case of any abnormality, stop the inverter immediately, and check it after switching off the power supply.
-------------------------	---

5.3 Illustration of basic operation

Illustration of inverter basic operation: we hereafter show various basic control operation processes by taking a 7.5kW inverter that drives a 7.5kW three-phase asynchronous AC motor as an example.

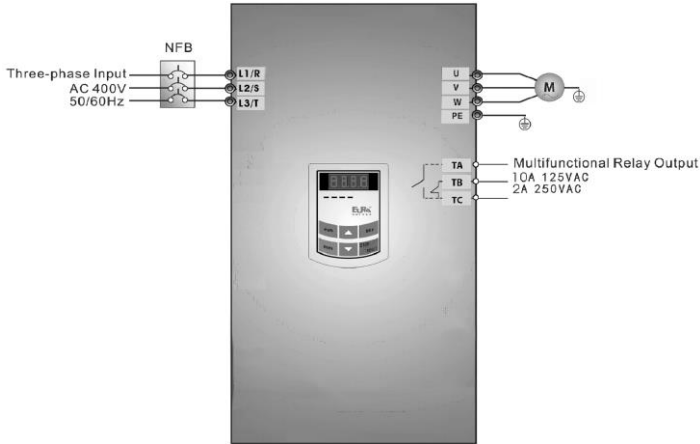

Figure 5-7 Wiring Diagram 1

The parameters indicated on the nameplate of the motor are as follows: 4 poles; rated power, 7.5kW; rated voltage, 400V; rated current, 15.4A; rated frequency 50.00HZ; and rated rotary speed, 1440rpm.

5.3.1 Operation process of frequency setting, start, forward running and stop with keypad panel

- (1) Connect the wires in accordance with Figure 5-7. After having checked the wiring successfully, switch on the air switch, and power on the inverter.
- (2) Press the “Fun” key, to enter the programming menu.
- (3) Measure the parameters of the motor

Function code	Values
F800	1(2)
F801	7.5
F802	400
F803	15.4
F805	1440

Press the “Run” key, to measure the parameters of the motor. After completion of the tuning, the motor will stop running, and relevant parameters will be stored in F806~F809. For the details of tuning of motor parameters, please refer to “Operation process of measuring the motor parameters” in this manual and Chapter XII of this manual. (Note: F800=1 is rotating tuning, F800=2 is stationary tuning. In the mode of rotating tuning, make sure to disconnect the motor from the load).

(4) Set functional parameters of the inverter:

Function code	Values
F111	50.00
F200	0
F201	0
F202	0
F203	0

(5) Press the “Run” key, to start the inverter;

(6) During running, current frequency of the inverter can be changed by pressing ▲ or ▼;

(7) Press the “Stop/Reset” key once, the motor will decelerate until it stops running;

(8) Switch off the air switch, and power off the inverter.

5.3.2 Operation process of setting the frequency with keypad panel, and starting, forward and reverse running, and stopping inverter through control terminals

(1) Connect the wires in accordance with Figure 5-2. After having checked the wiring successfully, switch on the air switch, and power on the inverter;

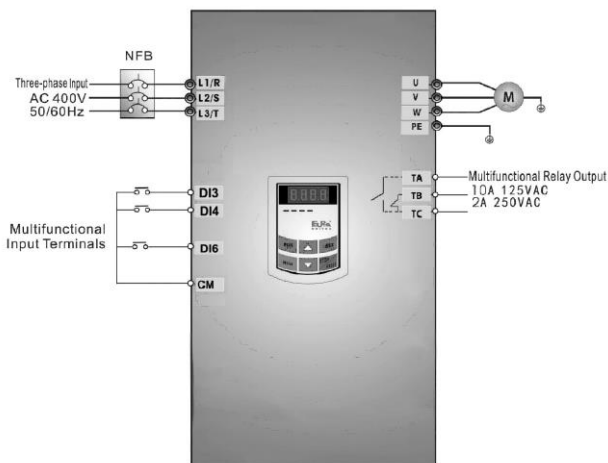

Figure 5-8 Wiring Diagram 2

- (2) Press the “Fun” key, to enter the programming menu.
- (3) Study the parameters of the motor: the operation process is the same as that of example 1.
- (4) Set functional parameters of the inverter:

Function code	Values
F111	50.00
F203	0
F208	1

- (5) Close the switch DI3, the inverter starts forward running;
- (6) During running, current frequency of the inverter can be changed by pressing ▲ or ▼;
- (7) During running, switch off the switch DI3, then close the switch DI4, the running direction of the motor will be changed (Note: The user should set the dead time of forward and reverse running F120 on the basis of the load. If it was too short, OC protection of the inverter may occur.)
- (8) Switch off the switches DI3 and DI4, the motor will decelerate until it stops running;
- (9) Switch off the air switch, and power off the inverter.

5.3.3 Operation process of jogging operation with keypad panel

Jogging operation includes two ways.

The first way is as below:

- (1) Connect the wires in accordance with Figure 5-7. After having checked the wiring successfully, switch on the air switch, and power on the inverter;
- (2) Press the “Fun” key, to enter the programming menu.
- (3) Study the parameters of the motor: the operation process is the same as that of example 1.
- (4) Set functional parameters of the inverter:

LED keypad parameters setting:

Function code	Values
F124	5.00
F125	30
F126	30
F132	1
F202	0

- (5) Press and hold the “Run” key until the motor is accelerated to the jogging frequency, and maintain the status of jogging operation.
- (6) Release the “Run” key, and the motor will decelerate until jogging operation is stopped;
- (7) Switch off the air switch, and power off the inverter.

The second way is as below:

- (1) Connect the wires in accordance with Figure 5-7. After having checked the wiring successfully, switch on the air switch, and power on the inverter;
- (2) Press the “Fun” key, to enter the programming menu.
- (3) Study the parameters of the motor: the operation process is the same as that of example 1.
- (4) Set functional parameters of the inverter:

LED keypad parameters setting:

Function code	Values
F124	5.00
F125	30
F126	30
F132	1
F643	1

Four-line LCD parameters setting:

Function code	Values
F124	5.00
F125	30
F126	30
F643	1

(5) When the keypad is LED, press and hold the “Run” key until the motor is accelerated to the jogging frequency, and maintain the status of jogging operation. When the keypad is LCD, press and hold the multifunction key until the motor is accelerated to the jogging frequency, and maintain the status of jogging operation. If F643=2, motor will reverse jogging.

(6) Release the “Run” key(LED keypad) or multifunction key (LCD keypad). The motor will decelerate until jogging operation is stopped;

(7) Switch off the air switch, and power off the inverter.

5.3.4 Operation process of setting the frequency with analog terminal and controlling the operation with control terminals

(1) Connect the wires in accordance with Figure 5-9. After having checked the wiring successfully, switch on the air switch, and power on the inverter. Note: 2K~5K potentiometer may be adopted for setting external analog signals. For the cases with higher requirements for precision, please adopt precise multiturn potentiometer, and adopt shielded wire for the wire connection, with near end of the shielding layer grounded reliably.

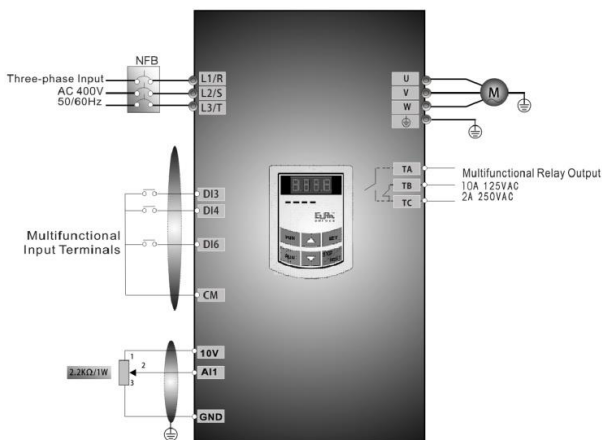

Figure 5-9 Wiring Diagram 3

- (2) Press the “Fun” key, to enter the programming menu.
- (3) Study the parameters of the motor: the operation process is the same as that of example 1.
- (4) Set functional parameters of the inverter:

Function code	Values
F203	1
F208	1

(5) There is a red two-digit coding switch SW1 near the control terminal block of 22 kW inverter and below 22 kW, as shown in Figure 5-10. The function of coding switch is to select the voltage signal (0~5V/0~10V) or current signal of analog input terminal AI2, current channel is default. In actual application, select the analog input channel through F203. And select voltage or current signal by F439. Turn switches 1 to ON and 2 to ON as illustrated in the figure, and select 0~20mA current speed control. Another switches states and mode of control speed are as table 5-2.

(6) There is a red four-digit coding switch SW1 near the control terminal block of above 30 kW inverter, as shown in Figure 5-11. The function of coding switch is to select the input range (0~5V/0~10V/0~20mA) of analog input terminal AI1 and AI2. In actual application, select the analog input channel through F203. And select voltage or current signal by F438 and F439AI1 channel default value is 0~10V, AI2 channel default value is 0~20mA. Another switches states and mode of control speed are as table 5-3.

- (7) There is a toggle switch S1 at the side of control terminals, please refer to Fig 5-12. S1 is used to select the voltage input range of AI1 channel. When turning S1 to “+”, the input range is 0~10V, when turning S1 to “-”, the input range is -10~10V.
- (8) Close the switch DI3, the motor starts forward running;
- (9) The potentiometer can be adjusted and set during running, and the current setting frequency of the inverter can be changed;
- (10) During running process, switch off the switch DI3, then, close DI4, the running direction of the motor will be changed;
- (11) Switch off the switches DI3 and DI4, the motor will decelerate until it stops running;
- (12) Switch off the air switch, and power off the inverter.
- (13) Analog output terminal AO2 can only output current signal, AO1 terminal can output voltage and current signal, the selecting switch is J5, please refer to Fig 5-13, the output relation is shown in table 5-4.

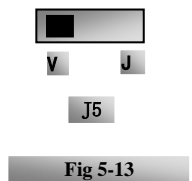
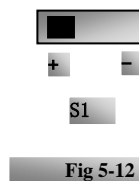
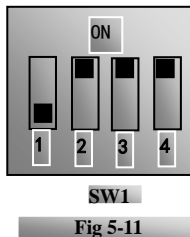
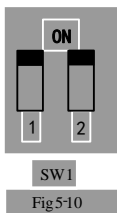

Table 5-2 The Setting of Coding Switch and Parameters in the Mode of Analog Speed Control

F203=2, channel AI2 is selected				F203=1, channel AI1 is selected	
Parameter	SW1 coding switch			S1 toggle switch	
F439	Coding Switch 1	Coding Switch 2	Mode of Speed Control	+	-
0	OFF	OFF	0~5V voltage	0~10V voltage	-10~10V voltage
0	OFF	ON	0~10V voltage		
1	ON	ON	0~20mA current		

Table 5-3 The Setting of Coding Switch and Parameters in the Mode of Analog Speed Control

		Set F203 to 1, to select channel AI1			Set F203 to 2, to select channel AI2			
Para.	Coding Switch SW1		Toggle switch S1	Analog signal range	Para.	Coding Switch SW1		
F438	Switch 1	Switch 3			F439	Switch 2	Switch 4	Analog signal range
0	OFF	OFF	+	0~5V voltage	0	OFF	OFF	0~5V voltage
0	OFF	ON	+	0~10V voltage	0	OFF	ON	0~10V voltage
1	ON	ON	+	0~20mA current	1	ON	ON	0~20mA current
0	OFF	ON	-	-10~10V voltage				
	OFF	OFF	-	Reserved				
	ON	ON	-	Reserved				

ON refers to switching the coding switch to the top, OFF refers to switching the coding switch to the bottom

Table 5-4 The relationship between AO1 and J5 and F423

AO1 output		Setting of F423		
		0	1	2
J5	V	0~5V	0~10V	Reserved
	I	Reserved	0~20mA	4~20mA

VI. Function Parameters

6.1 Basic parameters

F100	User's Password	Setting range: 0~9999	Mfr's value: 0
------	-----------------	-----------------------	----------------

When F107=1 with valid password, the user must enter correct user's password after power on or fault reset if you intend to change parameters. Otherwise, parameter setting will not be possible, and a prompt "Err1" will be displayed on the LED keypad, and "password is incorrect" will be displayed on the LCD keypad.

Relating function code: F107 Password valid or not F108 Setting user's password

F102	Inverter's Rated Current (A)		Mfr's value: Subject to inverter model
F103	Inverter Power (kW)		Mfr's value: Subject to inverter model
F104	Voltage level		Mfr's value: Subject to inverter model

-Rated current, rated power and voltage level can only be checked but cannot be modified.

F105	Software Edition No.	Setting range: 1.00~10.00	Mfr's value: Subject to inverter model
------	----------------------	---------------------------	--

Software Edition No. can only be checked but cannot be modified.

F106	Control mode	Setting range: 0:Sensorless vector control (SVC); 1: Closed-loop vector control (VC); 2: V/F; 3: Vector control 1 6: PMSM sensorless vector control	Mfr's value: 2
------	--------------	---	----------------

0: Sensorless vector control is suitable for the application of high-performance requirement. One inverter can only drive one motor.

1: Closed-loop vector control is suitable for the application of high-precision speed control and torque control. One inverter can only drive one motor, and the motor must install encoder. Encoder must be installed, and please set F851 and F854 correctly.

2: V/F control is suitable for common requirement of control precision or one inverter drives several motors.

3: Vector control 1 is auto torque promotion, which has the same function of F137=3. While studying motor parameters, motor does not need to be disconnected with load. One inverter can only drive one motor.

6: PMSM sensorless vector control is suitable for the application of high-performance requirement. One inverter can only drive one motor.

Note:

1. It is necessary to study the parameters of motor before inverter runs in the vector control mode (F106=0, 1, 3 and 6).

2. Under vector control mode (F106=0, 1, 3 and 6), one inverter can only drive one motor and the power of motor should be similar to the power of inverter. Otherwise, control performance will be increased or system cannot work properly.

3. Under vector control mode (F106=0 and 1), the max frequency (F111) must be lower than

500.00Hz.

4. The operator may input motor parameters manually according to the motor parameters given by motor manufactures.

5. Usually, the motor will work normally by inverter's default parameters, but the inverter's best control performance will not be acquired. Therefore, in order to get the best control performance, please study the parameters of motor before inverter runs in the vector control mode.

F107 Password Valid or Not	Setting range: 0: invalid; 1: valid 2: Invalid for communication 3: Menu lock screen enabled	Mfr's value: 0
F108 Setting User's Password	Setting range: 0~9999	Mfr's value: 8

·When F107 is set to 0, the function codes can be changed without inputting the password.

·When F107 is set to 1, the function codes can be changed only after inputting the user's password by F100.

·When F107 is set to 2, there is no need to input password when communication, the function codes can be changed.

·When F107 is set to 3, the function codes can be changed only after inputting the user's password by F100.

·The user can change "User's Password". The operation process is the same as those of changing other parameters.

· Input the value of F108 into F100, and the user's password can be unlocked.

Note: When password protection is valid, and if the user's password is not entered, F108 will display 0.

F109 Starting Frequency (Hz)	Setting range: 0.00~10.00	Mfr's value: 0.00
F110 Holding Time of Starting Frequency (S)	Setting range: 0.0~999.9	Mfr's value: 0.0

The inverter begins to run from the starting frequency. If the target frequency is lower than starting frequency, F109 is invalid.

The inverter begins to run from the starting frequency. After it keeps running at the starting frequency for the time as set in F110, it will accelerate to target frequency. The holding time is not included in acceleration/deceleration time.

Starting frequency is not limited by the Min frequency set by F112. If the starting frequency set by F109 is lower than Min frequency set by F112, inverter will start according to the setting parameters set by F109 and F110. After inverter starts and runs normally, the frequency will be limited by frequency set by F111 and F112.

Starting frequency should be lower than Max frequency set by F111.

Note: when speed track is adopted, F109 and F110 are invalid.

F111 Max Frequency (Hz)	Setting range: F113~590.0	Mfr's value: 50.00
F112 Min Frequency (Hz)	Setting range: 0.00~F113	Mfr's value: 0.50

·Max frequency is set by F111.

Note: in vector control mode (F106=0,1), the max frequency should be lower than 500Hz.

·Min frequency is set by F112.

·The setting value of min frequency should be lower than target frequency set by F113.

·The inverter begins to run from the starting frequency. During running process, if the given frequency is lower than min frequency, then inverter will stop.

Max/Min frequency should be set according to the nameplate parameters and running situations of motor. The motor is forbidden running at low frequency for a long time, or else motor will be damaged because of overheat.

F113 Target Frequency (Hz)	Setting range: F112~F111	Mfr's value: 50.00
----------------------------	--------------------------	--------------------

It shows the preset frequency. Under keypad speed control or terminal speed control mode, the inverter will run to this frequency automatically after startup.

F114	First Acceleration Time (S)	Setting range: 0.1~3000	Mfr's value: subject to inverter model
F115	First Deceleration Time (S)		
F116	Second Acceleration Time (S)		
F117	Second Deceleration Time (S)		

F119 is used to set the reference of setting accel/decel time.

The Acceleration/Deceleration time can be chosen by multifunction digital input terminals F316-F323 and connecting DI terminal with CM terminal. Please refer to the instructions of multi-functional input terminals. Note: when speed track is working, acceleration/deceleration time, min frequency and target frequency are invalid. After speed track is finished, inverter will run to target frequency according to acceleration/deceleration time.

F118	Turnover Frequency (Hz)	Setting range: 15.00~590.0	Mfr's value: 50.00
------	-------------------------	----------------------------	--------------------

Turnover frequency is the final frequency of V/F curve, and also is the least frequency according to the highest output voltage.

When running frequency is lower than this value, inverter has constant-torque output. When running frequency exceeds this value, inverter has constant-power output.

Note: during the process of speed track, turnover frequency is invalid. After speed track is finished, this function code is valid.

F119	The reference of setting accel/decel time	Setting range: 0: 0~50.00Hz 1: 0~max frequency 2: 0~target frequency	Mfr's value: 0
------	---	---	----------------

When F119=0, acceleration/ deceleration time means the time for inverter to accelerate/ decelerate from 0Hz (50Hz) to 50Hz (0Hz).

When F119=1, acceleration/ deceleration time means the time for inverter to accelerate/ decelerate from 0Hz (max frequency) to max frequency (0Hz).

When F119=2, acceleration/ deceleration time means the time for inverter to accelerate/ decelerate from 0Hz (target frequency) to target frequency (0Hz).

F120	Forward / Reverse Switchover dead-Time (S)	Setting range: 0.0~3000	Mfr's value: 0.0
------	--	-------------------------	------------------

· Within “forward/ reverse switchover dead-time”, this latency time will be canceled upon receiving “stop” signal. This function is suitable for all the speed control modes except automatic cycle operation.

· This function can ease the current impact in the process of direction switchover.

Note: during the process of speed track, F120 is invalid. After speed track is finished, this function code is valid.

F121	VF additional compensation	Setting range: 0: Invalid 1: Valid	Mfr's value:0
------	----------------------------	------------------------------------	---------------

This function is used to increase output torque. Please set accurate motor parameters and auto-tune motor stator resistor.

Note: when one inverter drives several motors, please close this function.

F122	Reverse Running Forbidden	Setting range: 0: invalid; 1: valid	Mfr's value: 0
------	---------------------------	-------------------------------------	----------------

When F122=1, inverter will only run forward no matter the state of terminals and the parameters set by F202.

Inverter will not run reverse and forward / reverse switchover is forbidden. If reverse signal is given, inverter will stop.

If reverse running locking is valid (F202=1), whatever speed track is valid or not, inverter has no output.

When F122=1, F613=1 and inverter gets forward running command and motor is sliding reverse, if inverter can detect the sliding direction and track to motor speed, then inverter will run to 0.0Hz reverse, then run forward

according to the setting value of parameters.

F123 Minus frequency is valid in the mode of combined speed control.	0: Invalid; 1: valid	0
--	----------------------	---

In the mode of combined speed control, if running frequency is minus and F123=0, inverter will stop; if F123=1, inverter will run reverse at this frequency. (This function is controlled by F122.)

F124 Jogging Frequency (Hz)	Setting range: F112~F111	Mfr's value: 5.00
F125 Jogging Acceleration Time (S)	Setting range: 0.1~3000	Mfr's value: subject to inverter model
F126 Jogging Deceleration Time (S)		

There are two types of jogging: keypad jogging and terminal jogging. Keypad jogging is valid only under stopped status (F132 including of displaying items of keypad jogging should be set). Terminal jogging is valid under both running status and stopped status.

Carry out jogging operation through the keypad (under stopped status):

- Press the "Fun" key, it will display "HF-0";
- Press the "Run" key, the inverter will run to "jogging frequency" (if pressing "Fun" key again, "keypad jogging" will be cancelled).

·In case of terminal jogging, make "jogging"

terminal (such as DI1) connected to CM, and inverter will run to jogging frequency. The rated function codes are from F316 to F323.

Note: when jogging function is valid, speed track function is invalid.

F127/F129 Skip Frequency A,B (Hz)	Setting range: 0.00~590.0	Mfr's value:0.00
F128/F130 Skip Width A,B (Hz)	Setting range: 0.00~2.50	Mfr's value: 0.00

·Systematic vibration may occur when the motor is running at a certain frequency. This parameter is set to skip this frequency.

The inverter will skip the point automatically when output frequency is equal to the set value of this parameter.

"Skip Width" is the span from the upper to the lower limits around Skip Frequency. For example, Skip Frequency=20Hz, Skip Width=0.5Hz, inverter will skip automatically when output is between 19.5~20.5Hz.

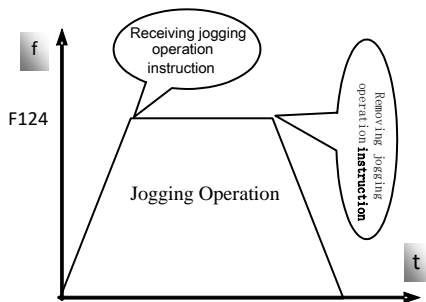

Figure 6-1 Jogging Operation

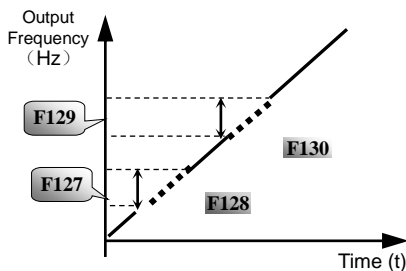

Figure 6-2 Skip Frequency

Inverter will not skip this frequency span during acceleration/deceleration.

Note: during the process of speed track, skip frequency function is invalid. After speed track is finished, this function is valid.

F131 Running Display Items	0—Current output frequency/function-code 1—Output rotary speed 2—Output current 4—Output voltage 8—PN voltage 16—PID feedback value 32—Temperature 64—Count values 128—Linear speed 256—PID given value 512—Yarn length 1024—Center frequency 2048—Output power 4096— Output torque	Mfr's value: $0+1+2+4+8=15$
----------------------------	--	--------------------------------

Selection of one value from 1, 2, 4, 8, 16, 32, 64 and 128 shows that only one specific display item is selected. Should multiple display items be intended, add the values of the corresponding display items and take the total values as the set value of F131, e.g., just set F131 to be 19 (1+2+16) if you want to call “current output rotary speed”, “output current” and “PID feedback value”. The other display items will be covered.

As F131=8191, all display items are visible, of which, “frequency/function-code” will be visible whether or not it is selected.

Should you intend to check any display item of LED keypad, just press the “Fun” key for switchover.

Should you intend to check any display item of four-line LCD, press “Fun” key and press  key to check them.

Whatever the value of F131 is set to, corresponding target frequency will flash under stopped status.

The units and representing methods for each physical quantity in LED keypad are displayed as below:

Target rotary speed is an integral number. If it exceeds 9999, add a decimal point to it.

Current display A** Voltage display U*** Count value **** Temperature H***

Linear speed L***. If it exceeds 999, add a decimal point to it. If it exceeds 9999, add two decimal points to it, and the like.

PID given value o** PID feedback value b** Yarn length * center frequency **

output power ** output torque **

Note: when count value is displayed and it exceeds 9999, only 4 digits are displayed and add a decimal point to it, i.e. 12345 is displayed in the form of 1234.

In four-line LCD interface, the displayed item will be shown alternately on the fourth line of level 3 menu in F131.

F132	Display items of stop	Setting range: 0: Frequency/function-code 1: Keypad jogging 2: Target rotary speed 4: PN voltage 8: PID feedback value 16: Temperature 32: Count values 64: PID given value 128: Yarn length 256: Center frequency 512: Setting torque	Mfr's value: 0+2+4=6
F133	Drive ratio of driven system	Setting range: 0.10~200.0	Mfr's value: 1.00
F134	Transmission-wheel radius	0.001~1.000 (m)	Mfr's value: 0.001

Calculation of rotary speed and linear speed:

For example, If inverter's max frequency F111=50.00Hz, numbers of motor poles F804=4, drive ratio F133=1.00, transmission-shaft radius R=0.05m, then

Transmission shaft perimeter: $2\pi r = 2 \times 3.14 \times 0.05 = 0.314$ (meter)

Transmission shaft rotary speed: $60 \times \text{operation frequency} / (\text{numbers of poles pairs} \times \text{drive ratio}) = 60 \times 50 / (2 \times 1.00) = 1500$ rpm

Endmost linear speed: rotary speed \times perimeter = $1500 \times 0.314 = 471$ (meters/second)

F135	User macro	Setting range: 0: Invalid 1: user macro 1 2: user macro 2	Mfr's value: 0
------	------------	--	----------------

When F135=0, user macro parameters are not saved.

When F135=1, all setting parameters are saved in user macro 1.

When F135=2, all setting parameters are saved in user macro 2.

After macro is saved, user can check macro by setting F160=21 or F160=22.

F136	Slip compensation (%)	Setting range: 0~10	Mfr's value: 0
------	-----------------------	---------------------	----------------

·Under V/F controlling, rotary speed of motor rotor will decrease as load increases. Be assured that rotor rotate speed is near to synchronization rotary speed while motor with rated load, slip compensation should be adopted according to the setting value of frequency compensation.

Note: during the process of speed track, slip compensation function is invalid. After speed track is finished, this function is valid.

F137	Modes of torque compensation	Setting range: 0: Linear compensation; 1: Square compensation; 2: User-defined multipoint compensation 3: Auto torque compensation 4: V/F separation	Mfr's value: 0
------	------------------------------	---	----------------

F138 Linear compensation	Setting range: 1~20	Mfr's value: subject to inverter model
F139 Square compensation	Setting range: 1: 1.5 2: 1.8 3: 1.9 4: 2.0 5~6: Reserved	Mfr's value: 1

When F106=2, the function of F137 is valid.

To compensate low-frequency torque controlled by V/F, output voltage of inverter while low-frequency should be compensated.

When F137=0, linear compensation is chosen and it is applied on universal constant-torque load;

When F137=1, square compensation is chose and it is applied on the loads of fan or water pump;

When F137=2, user-defined multipoint compensation is chosen and it is applied on the special loads of spin-drier or centrifuge;

This parameter should be increased when the load is heavier, and this parameter should be decreased when the load is lighter.

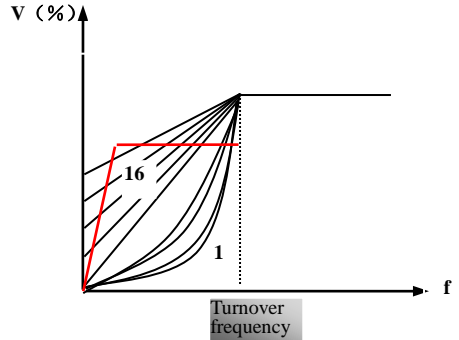

Fig 6-3 Torque Promotion

If the torque is elevated too much, motor is easy to overheat, and the current of inverter will be too high. Please check the motor while elevating the torque.

When F137=3, auto torque compensation is chose and it can compensate low-frequency torque automatically, to diminish motor slip, to make rotor rotary speed close to synchro rotary speed and to restrain motor vibration. Customers should set correctly motor power, rotary speed, numbers of motor poles, motor rated current and stator resistance. Please refer to the chapter “Operation process of measuring motor parameters”.

When F137=4, output voltage is not related to output frequency, output frequency is controlled by frequency source, and output voltage is controlled by F671.

F140 Voltage compensation point frequency (Hz)	Setting range: 0.00~F142	Mfr's value: 1.00
F141 Voltage compensation point 1 (%)	Setting range: 0~30	Mfr's value: 0
F142 User-defined frequency point F2	Setting range: F140~F144	Mfr's value: 5.00
F143 User-defined voltage point V2(%)	Setting range: 0~100	Mfr's value: 13
F144 User-defined frequency point F3	Setting range: F142~F146	Mfr's value: 10.00
F145 User-defined voltage point V3(%)	Setting range: 0~100	Mfr's value: 24

F146	User-defined frequency point F4	Setting range: F144~F148	Mfr's value: 20.00
F147	User-defined voltage point V4(%)	Setting range: 0~100	Mfr's value: 45
F148	User-defined frequency point F5	Setting range: F146~F150	Mfr's value: 30.00
F149	User-defined voltage point V5(%)	Setting range: 0~100	Mfr's value: 63
F150	User-defined frequency point F6	Setting range: F148~F118	Mfr's value: 40.00
F151	User-defined voltage point V6(%)	Setting range: 0~100	Mfr's value: 81

AS shown in Fig6-3, when F317=0, VF curve compensation =Max (F138, F141)

When F137=1, VF curve compensation =Max (F139, F141)

When F137=2, VF curve compensation =Max (auto compensation, F141)

When F317=3, auto compensation.

F141 cannot be set to high, otherwise, inverter will easily trip into OH and OC.

Multi-stage V/F curves are defined by 12 parameters from F140 to F151.

The setting value of V/F curve is set by motor load characteristic.

Note: $V1 < V2 < V3 < V4 < V5 < V6$, $F1 < F2 < F3 < F4 < F5 < F6$. As low-frequency, if the setting voltage is too high, motor will overheat or be damaged. Inverter will be stalling or occur over-current protection.

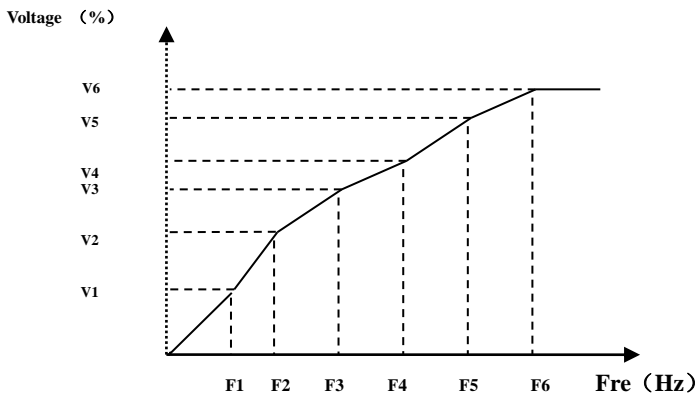

Fig 6-4 Polygonal-Line Type V/F

Note: during the process of speed track, polygonal-line V/F curve function is invalid. After speed track is finished, this function is valid.

F152 Output voltage corresponding to turnover frequency	Setting range: 10~100	Mfr's value: 100
---	-----------------------	------------------

This function can meet the needs of some special loads, for example, when the frequency outputs 300Hz and corresponding voltage outputs 200V (supposed voltage of inverter power supply is 400V), turnover

frequency F118 should be set to 300Hz and F152 is set to $(200-400) \times 100 = 50$. And F152 should be equal to 50.

Please pay attention to nameplate parameters of motor. If the working voltage is higher than rated voltage or the frequency is higher than rated frequency, motor would be damaged.

Note: during the process of speed track, slip compensation function is invalid. After speed track is finished, this function is valid.

F153	Carrier frequency setting	Setting range: subject to model	Mfr's value: subject to model
------	---------------------------	---------------------------------	-------------------------------

Carrier-wave frequency of inverter is adjusted by setting this code function. Adjusting carrier-wave may reduce motor noise, avoid point of resonance of mechanical system, decrease leakage current of wire to earth and the interference of inverter.

When carrier-wave frequency is low, although carrier-wave noise from motor will increase, the current leaked to the earth will decrease. The wastage of motor and the temperature of motor will increase, but the temperature of inverter will decrease.

When carrier-wave frequency is high, the situations are opposite, and the interference will raise.

When output frequency of inverter is adjusted to high frequency, the setting value of carrier-wave should be increased. Performance is influenced by adjusting carrier-wave frequency as below table:

Carrier-wave frequency	Low → High
Motor noise	Loud → Low
Waveform of output current	Bad → Good
Motor temperature	High → Low
Inverter temperature	Low → High
Leakage current	Low → High
Interference	Low → High

F154 Automatic voltage rectification	Setting range: 0: Invalid 1: Valid 2: Invalid during deceleration process	Mfr's value: 0
--------------------------------------	--	----------------

This function is enable to keep output voltage constant automatically in the case of fluctuation of input voltage, but the deceleration time will be affected by internal PI adjust. If deceleration time is forbidden being changed, please select F154=2.

F155	Digital accessory frequency setting	Setting range: 0.00~F111	Mfr's value: 0.00
F156	Digital accessory frequency polarity setting	Setting range: 0 ~ 1	Mfr's value: 0
F157	Reading accessory frequency		
F158	Reading accessory frequency polarity		

Under combined speed control mode, when accessory frequency source is digital setting memory (F204=0), F155 and F156 are considered as initial set values of accessory frequency and polarity (direction).

In the mode of combined speed control, F157 and F158 are used for reading the value and direction of accessory frequency.

For example, when F203=1, F204=0. F207=1, the given analog frequency is 15Hz, inverter is required to run to 20Hz. In case of this requirement, user can push "UP" button to raise the frequency from 15Hz to 20Hz. User can also set

F155=5Hz and F160=0 (0 means forward, 1 means reverse). In this way, inverter can be run to 20Hz directly.

F159 Random carrier-wave selection	Setting range: 0: Invalid 1: Valid	Mfr's value: 0
------------------------------------	------------------------------------	----------------

When F159=0, inverter will modulate as per the carrier-wave set by F153. When F159=1, inverter will operate in mode of random carrier-wave modulating.

Note: when random carrier-wave is selected, output torque will increase but noise will be loud. When the carrier-wave set by F153 is selected, noise will be reduced, but output torque will decrease. Please set the value according to the situation.

F160 Reverting to manufacturer values	Setting range: 0: Invalid 1: Valid 21: revert user macro 1 22: revert user macro 2	Mfr's value: 0
---------------------------------------	--	----------------

·When there is disorder with inverter's parameters and manufacturer values need to be restored, set F160=1. After "Reverting to manufacturer values" is done, F160 values will be automatically changed to 0.

After setting F135, user can check the parameters of related macro parameters by setting F160. When F160=21, the parameters of macro 1 are reverted. When F160=22, the parameters of macro are reverted.

· "Reverting to manufacturer values" will not work for the function-codes marked "o" in the "change" column of the parameters table. These function codes have been adjusted properly before delivery. And it is recommended not to change them.

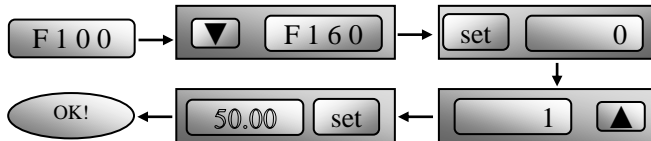

Figure 6-5 Reverting to manufacturer values

6.2 Operation Control

F200 Source of start command	Setting range: 0: Keypad command; 1: Terminal command; 2: Keypad+Terminal; 3: MODBUS; 4: Keypad+Terminal+MODBUS	Mfr's value: 4
F201 Source of stop command	Setting range: 0: Keypad command; 1: Terminal command; 2: Keypad+Terminal; 3: MODBUS; 4: Keypad+Terminal+MODBUS	Mfr's value: 4

·F200 and F201 are the resource of selecting inverter control commands.

·Inverter control commands include: starting, stopping, forward running, reverse running, jogging, etc.

·"Keypad command" refers to the start/stop commands given by the "Run" or "stop/reset" key on the keypad.

·"Terminal command" refers to the start/stop command given by the "Run" terminal defined by F316-F323.

·When F200=3 and F201=3, the running command is given by MODBUS.

·When F200=2 and F201=2, "keypad command" and "terminal command" are valid at the mean time, F200=4 and F201=4 are the same.

F202 Mode of direction setting	Setting range: 0: Forward running locking; 1: Reverse running locking; 2: Terminal setting 3: Keypad setting 4: Keypad setting and direction in memory	Mfr's value: 0
-----------------------------------	---	----------------

The running direction is controlled by this function code together with other speed control mode which can set the running direction of inverter. When auto-circulation speed is selected by F500=2, this function code is not valid.

When speed control mode without controlling direction is selected, the running direction of inverter is controlled by this function code, for example, keypad controls speed.

Direction given by F202	Direction given by other control mode	Running direction	remarks
0	0	0	0 means forward. 1 means reverse.
0	1	1	
1	0	1	
1	1	0	

When F202=3, the running direction can be changed by pressing FWD/REV key. After power off and repower on the inverter, the default running direction is forward.

When F202=4, the running direction can be changed by pressing FWD/REV key. The setting direction by keypad is in memory.

<p>F203 Main frequency source X</p>	<p>Setting range: 0: Memory of digital given; 1: External analog AI1; 2: External analog AI2; 3: Pulse input given; 4: Stage speed control; 5: No memory of digital given; 6: Keypad potentiometer; 7: Reserved; 8:Reserved; 9: PID adjusting; 10: MODBUS</p>	<p>Mfr's value: 0</p>
---	---	-----------------------

·Main frequency source is set by this function code.

0: Memory of digital given

Its initial value is the value of F113. The frequency can be adjusted through the key “up” or “down”, or through the “up”, “down” terminals.

“Memory of digital given” means after inverter stops, the target frequency is the running frequency before stop. If the user would like to save target frequency in memory when the power is disconnected, please set F220=1, i.e. frequency memory after power down is valid.

1: External analog AI1; 2: External analog AI2

The frequency is set by analog input terminal AI1 and AI2. The analog signal may be current signal (0-20mA or 4-20mA) or voltage signal (0-5V or 0-10V), which can be chosen by switch code. Please adjust the switch code according to practical situations, refer to fig 5-4 and table 5-2.

When inverters leave the factory, the analog signal of AI1 channel is DC voltage signal, the range of voltage is 0-10V, and the analog signal of AI2 channel is DC current signal, the range of current is 0-20 mA. If 4-20mA current signal is needed, please set lower limit of analog input F406=2, which input resistor is 500OHM. If some errors exist, please make some adjustments.

3: Pulse input given

When frequency is given by pulse input, the pulse is only inputted by DI1 terminal. The max pulse frequency is 10K. The related parameters are from F440 to F446.

4: Stage speed control

Multi-stage speed control is selected by setting stage speed terminals F316-F323 and function codes of multi-stage speed section. The frequency is set by multi-stage terminal or automatic cycling frequency.

5: No memory of digital given

Its initial value is the value of F113. The frequency can be adjusted through the key “up” or “down”, or through the “up”, “down” terminals.

“No memory of digital given” means that the target frequency will restore to the value of F113 after stop no matter the state of F220.

6: Keypad Potentiometer AI3

The frequency is set by the analog on the control panel. When the potentiometer in remote keypad is used, please set F422=1.

9: PID adjusting

E2000

When PID adjusting is selected, the running frequency of inverter is the value of frequency adjusted by PID. Please refer to instructions of PID parameters for PID given resource, PID given numbers, feedback source, and so on.

10: MODBUS

The main frequency is given by MODBUS communication.

F204 Accessorial frequency source Y	Setting range: 0: Memory of digital given; 1: External analog AI1; 2: External analog AI2; 3: Pulse input given; 4: Stage speed control; 5: PID adjusting; 6: Keypad potentiometer AI3	Mfr's value: 0
-------------------------------------	--	----------------

·When accessorial frequency Y is given to channel as independent frequency, it has the same function with main frequency source X.

· When F204=0, the initial value of accessorial frequency is set by F155. When accessorial frequency controls speed independently, polarity setting F156 is not valid.

·When F207=1 or 3, and F204=0, the initial value of accessorial frequency is set by F155, the polarity of accessorial frequency is set by F156, the initial value of accessorial frequency and the polarity of accessorial frequency can be checked by F157 and F158.

·When the accessorial frequency is given by analog input (AI1, AI2), the setting range for the accessorial frequency is set by F205 and F206.

·Note: accessorial frequency source Y and main frequency source X can not use the same frequency given channel.

F205 reference for selecting accessorial frequency source Y range	Setting range: 0: Relative to max frequency; 1: Relative to main frequency X	Mfr's value: 0
F206 Accessorial frequency Y range (%)	Setting range: 0~150	Mfr's value: 100

·When combined speed control is adopted for frequency source, F206 is used to confirm the relative object of the setting range for the accessorial frequency.

F205 is to confirm the reference of the accessorial frequency range. If it is relative to main frequency, the range will change according to the change of main frequency X.

F207 Frequency source selecting	Setting range: 0: X; 1: X+Y; 2: X or Y (terminal switchover); 3: X or X+Y (terminal switchover); 4: Combination of stage speed and analog 5: X-Y 6: X+Y-Y _{MAX} *50% 7: combination 1 of stage speed and digital 9: X/Y 10: Max (X,Y) 11: Min (X,Y)	Mfr's value: 0
---------------------------------	---	----------------

Select the channel of setting the frequency. The frequency is given by combination of main frequency X and accessorial frequency Y.

·When F207=0, the frequency is set by main frequency source.

When F207=1, X+Y, the frequency is set by adding main frequency source to accessorial frequency source. X or Y can be given by PID.

When F207=2, main frequency source and accessorial frequency source can be switched over by frequency source switching terminal.

When F207=3, main frequency given and adding frequency given(X+Y) can be switched over by frequency source switching terminal. X or Y can be given by PID.

When F207=4, stage speed setting of main frequency source has priority over analog setting of accessorial frequency source (only suitable for F203=4 F204=1).

When F207=5, X-Y, the frequency is set by subtracting accessorial frequency source from main frequency source. If the frequency is set by main frequency or accessorial frequency, PID speed control can be selected.

When F207=6, $X+Y-Y_{MAX} \times 50\%$, the frequency is given by both main frequency source and accessorial frequency source. X or Y can be given by PID. When F205=0, $Y_{MAX}=F111 \times F206$. When F205=1, $Y_{MAX}=X \times F206$.

When F207=7, stage speed setting of main frequency source has priority over digital of accessorial frequency source. (only suitable for F203=4, F204=0).

When F207=9, target frequency is main frequency source X dividing accessorial frequency source Y.

When F207=7, target frequency is max value of main frequency source X and accessorial frequency source Y.

When F207=7, target frequency is min value of main frequency source X and accessorial frequency source Y.

Note:

- When F203=4 and F204=1, the difference between F207=1 and F207=4 is that when F207=1, frequency source selecting is the addition of stage speed and analog, when F207=4, frequency source selecting is stage speed with stage speed and analog given at the same time. If stage speed given is canceled and analog given still exists, inverter will run by analog given.
- Frequency given mode can be switched over by selecting F207. For example: switching PID adjusting and normal speed control, switching stage speed and analog given, switching PID adjusting and analog given, and so on.
- The acceleration/deceleration time of stage speed is set by function code of corresponding stage speed time.
- The mode of automatic cycle speed control is unable to combine with other modes.
- When F207=2 (main frequency source and accessorial frequency source can be switched over by terminals), if main frequency is not set to be under stage-speed control, accessorial frequency can be set to be under automatic cycle speed control (F204=5, F500=0). Through the defined switchover terminal, the control mode (defined by X) and automatic cycle speed control (defined by Y) can be freely switched.
- When F207=6, F205=0 and F206=100, $X+Y-Y_{MAX} \times 50\% = X+Y-F111 \times 50\%$, and if F207=6, F205=1 and F206=100, then $X+Y-Y_{MAX} \times 50\% = X+Y-X \times 50\%$.

F208 Terminal two-line/three-line	Setting range: 0: No function 1: Two-line operation mode 1;	Mfr's value: 0
---	---	----------------

operation control	2: Two-line operation mode 2; 3: three-line operation mode 1; 4: three-line operation mode 2; 5: start/stop controlled by direction pulse	
-------------------	--	--

•When selecting two-line type or three-line type), F200, F201 and F202 are invalid.

•Five modes are available for terminal operation control.

Note: “FWD”, “REV” and “X” are three terminals designated in programming DI1~DI8.

1: Two-line mode 1: this mode is the most popularly used two-line mode. The running direction of mode is controlled by FWD, REV terminals.

For example: “FWD” terminal-----“open”: stop, “closed”: forward running;

“REV” terminal-----“open”: stop, “closed”: reverse running;

“CM” terminal-----common port

K1	K2	Running command
0	0	Stop
1	0	Forward running
0	1	Reverse running
1	1	Stop

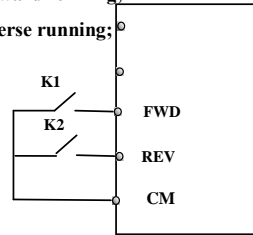

2. Two-line mode 2: when this mode is used, FWD is enable terminal, the direction is controlled by REV terminal.

For example: “FWD” terminal-----“open”: stop, “closed”: running;

“REV” terminal-----“open”: forward running,

“closed”: reverse running;

“CM” terminal-----common port

K1	K2	Running command
0	0	Stop
0	1	Stop
1	0	Forward running
1	1	Reverse running

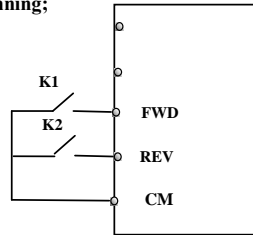

3. Three-line mode 1:

In this mode, X terminal is enable terminal, the direction is controlled by FWD terminal and REV terminal. Pulse signal is valid.

Stopping commands is enabled by opening X terminal.

SB3: Stop button

SB2: Forward button.

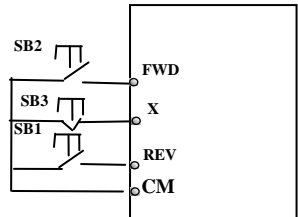

SB1: Reverse button.

4. Three-line mode 2:

In this mode, X terminal is enable terminal, running command is controlled by FWD terminal. The running direction is controlled by REV terminal, and stopping command enable by opening X terminal.

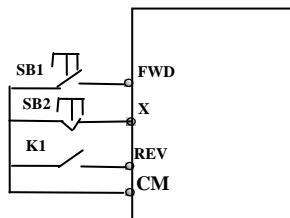
**SB1: Running button****SB2: Stop button****K1: direction switch. Open stands for forward running; close stands for reverse running.**

5. Start/stop controlled by direction pulse:

“FWD” terminal—(impulse signal: forward/stop)**“REV” terminal—(impulse signal: reverse/stop)****“CM” terminal—common port**

Note: when pulse of SB1 triggers, inverter will run forward. When the pulse triggers again, inverter will stop running.

When pulse of SB2 triggers, inverter will run reverse. When the pulse triggers again, inverter will stop running.

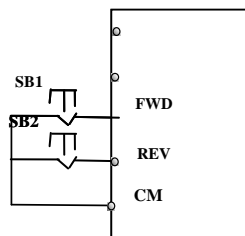

F209	Selecting the mode of stopping the motor	Setting range: 0: stop by deceleration time; 1: free stop 2: Stop by DC braking	Mfr's value: 0
------	--	---	----------------

When the stop signal is input, stopping mode is set by this function code:

F209=0: stop by deceleration time

Inverter will decrease output frequency according to setting acceleration/deceleration curve and decelerating time, after frequency decreases to 0, inverter will stop. This is often common stopping type. During the process of speed track, this function is invalid. And inverter will be forced to stop during this process.

F209=1: free stop

After stop command is valid, inverter will stop output. Motor will free stop by mechanical inertia.

When F209=2, after inverter receives stop command, inverter will stop from present frequency by DC braking. Please set F656, F603 and F605 correctly to avoid error.

F210	Frequency display accuracy	Setting range: 0.01~10.00	Mfr's value: 0.01
------	----------------------------	---------------------------	-------------------

When inverter is in the running status, under keypad speed control, frequency display accuracy is set by F210 and the range is from 0.01 to 2.00. For example, when F210=0.5, ▲/▼ terminal is pressed at one time, frequency will increase or decrease by 0.5Hz.

This function is valid when inverter is in the running state.

F211	Speed of digital control (Hz/S)	Setting range: 0.01~100.0	Mfr's value: 5.00
------	---------------------------------	---------------------------	-------------------

When UP/DOWN terminal is pressed, frequency will change at the setting rate. The Mfr's value is

5.00Hz/s.

F212 Direction memory	Setting range: 0: Invalid 1: Valid	Mfr's value: 0
-----------------------	------------------------------------	----------------

· This function is valid when three-line operation mode 1(F208=3) is valid.

· When F212=0, after inverter is stopped, resetted and repowered on, the running direction is not memorized.

· When F212=1, after inverter is stopped, resetted and repowered on, if inverter starts running but no direction signal, inverter will run according the memory direction.

F213 Auto-starting after repowered on	Setting range: 0: invalid; 1: valid	Mfr's value: 0
F214 Auto-starting after reset	Setting range: 0: invalid; 1: valid	Mfr's value: 0

Whether or not to start automatically after repowered on is set by F213

F213=1, Auto-starting after repowered on is valid. When inverter is power off and then powered on again, it will run automatically after the time set by F215 and according to the running mode before power-down.

If F220=0 frequency memory after power-down is not valid, inverter will run by the setting value of F113.

F213=0, after repower-on, inverter will not run automatically unless running command is given to inverter.

Whether or not to start automatically after fault resetting is set by F214

When F214=1, if fault occurs, inverter will reset automatically after delay time for fault reset (F217). After resetting, inverter will run automatically after the auto-starting delay time (F215).

If frequency memory after power-down (F220) is valid, inverter will run at the speed before power-down.

Otherwise, inverter will run at the speed set by F113.

In case of fault under running status, inverter will reset automatically and auto-start. In case of fault under stopped status, the inverter will only reset automatically.

When F214=0, after fault occurs, inverter will display fault code, it must be reset by manually.

F215 Auto-starting delay time (S)	Setting range: 0.1~3000	Mfr's value: 60.0
-----------------------------------	-------------------------	-------------------

F215 is the auto-starting delay time for F213 and F214. The range is from 0.1s to 3000.0s.

F216 Times of auto-starting in case of repeated faults	Setting range: 0~5	Mfr's value: 0
F217 Delay time for fault reset	Setting range: 0.0~3000.0	Mfr's value: 3.0
F219 EEPROM write operation	Setting range: 0: enabled to write 1: prohibit writing	Mfr's value: 1

F216 sets the most times of auto-starting in case of repeated faults. If starting times are more than the setting value of this function code, inverter will not reset or start automatically after fault. Inverter will run after running command is given to inverter manually.

F217 sets delay time for fault reset. The range is from 0.0 to 10.0S which is time interval from fault to resetting.

When F219=1 (address 2001H is not operated by PC/PLC), the function code is modified by communication, and it is not saved in the EEPROM. It means there is no memory when power down.

When F219=0 ((address 2001H is not operated by PC/PLC), the function code is modified by communication, and it is saved in the EEPROM. It means there is memory when power down.

F220 Frequency memory after power-down	Setting range: 0: invalid; 1: valid	Mfr's value: 0
--	-------------------------------------	----------------

F220 sets whether or not frequency memory after power-down is valid.

This function is valid for F213 and F214. Whether or not to memory running state after power-down or malfunction is set by this function.

The function of frequency memory after power-down is valid for main frequency and accessorial frequency that is given by digital. Because the digital given accessorial frequency has positive polarity and negative polarity, it is saved in the function codes F155 and F156.

F221 X+Y-50% (%)	Setting range: 0~200	Mfr's value: 50
F222 count memory selection	Setting range: 0: Invalid 1: Valid	Mfr's value: 0

F220 sets whether or not count memory is valid. Whether or not to memory counting values after power-down or malfunction is set by this function.

F223 Main frequency coefficient	Setting range: 0.0~100.0	Mfr's value: 100.0
---------------------------------	--------------------------	--------------------

Target frequency=main frequency*main frequency coefficient.

F224 when target frequency is lower than Min frequency	Setting range: 0: stop 1: run at min frequency	Mfr's value: 0
--	---	----------------

·F224=0, when target frequency is lower than Min frequency, inverter will stop.

·F224=1, when target frequency is lower than Min frequency, inverter will run at Min frequency.

Table 6-1 Combination of Speed Control

F203 \ F204	0. Memory of digital setting	1 External analog AI1	2 External analog AI2	3 Pulse input given	4 Terminal stage speed control	5 PID adjusting	6 Analog AI3
0 Memory of Digital setting	○	●	●	●	●	●	●
1 External analog AI1	●	○	●	●	●	●	●
2 External analog AI2	●	●	○	●	●	●	●
3 Pulse input given	●	●	●	○	●	●	●
4 Terminal Stage speed control	●	●	●	●	○	●	●
5 Digital setting	○	●	●	●	●	●	●
6 Analog AI3	●	●	●	●	●	●	○
9 PID adjusting	●	●	●	●	●	○	●
10 MODBUS	●	●	●	●	●	●	●

●: Inter-combination is allowable.

○: Combination is not allowable.

The mode of automatic cycle speed control is unable to combine with other modes. If the combination

includes the mode of automatic cycle speed control, only main speed control mode will be valid.

F226 Action of skipping frequency	Setting range: 0: no action during accel/decel 1: no action during decelerating 2. valid at any time	Mfr's value: 0
-----------------------------------	---	----------------

- F226=0, inverter will not skip the F127/F129 during accelerating and decelerating. It works during running with stable speed.
- F226=1, inverter will not skip F127/129 during decelerating. It only works during running with stable speed or acceleration.
- F226=2, it works at accelerating, decelerating and running with stable speed.

Please refer to F127~F130 for other function codes.

Note: the frequency skipping width should not be too large during decelerating.

F233 Accel/decel time unit	Setting range: 0: 0.1s; 1: 0.01s;	Mfr's value: 0
----------------------------	-----------------------------------	----------------

When F233=0, the accuracy of F114~F117 and stage speed is 0.1s;

When F233=1, the accuracy of F114~F117 and stage speed is 0.01s;

F234 switchover frequency during deceleration process (Hz)	Setting range: 0.00: invalid 0.00~F111	Mfr's value: 0.00
--	---	-------------------

When F234=0, this function is invalid.

When F234≠0, if the running frequency is higher than F234, the decelerating time is normal. If the running frequency is lower than F234, the decelerating time is the 2nd decelerating time(F117).

Note: this function code is only for special function of washing machine.

Traversal Operating function

Traversal operation is widely used in textile and chemical fiber industry.

F235	Traversal operating mode	0: Invalid 1: Traversal operating mode 1 2: Traversal operating mode 2 3: Traversal operating mode 3	Mfr's value: 0
------	--------------------------	---	----------------

F235=0, this function is invalid.

F235=1, traversal operating mode 1, the central frequency is set by F242, and the working process is shown in Fig 6-6.

F235=2, traversal operating mode 2, the central frequency is on the decrease 6-6, the working process is shown in Fig 6-7.

F235=3, traversal operating mode 3, the central frequency is set by F203. Under this mode, if the central frequency set by F203 is lower than the lower limit of central frequency, inverter will not stop running. In the other traversal operating mode, the value of central frequency is controlled by F243.

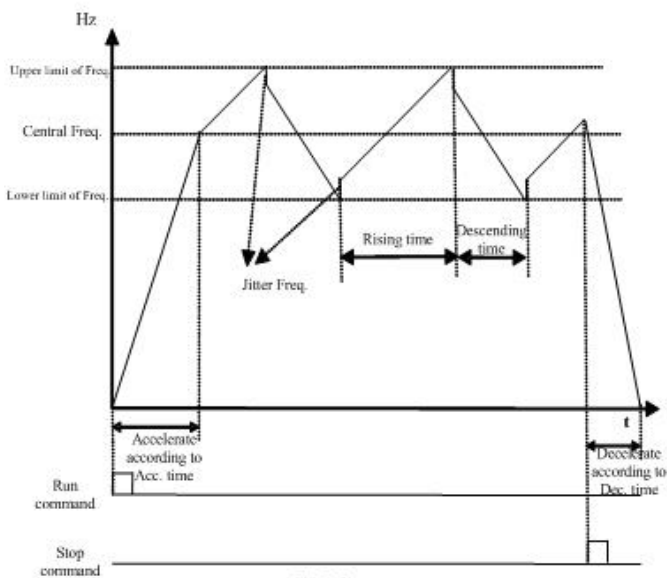

Fig 6-6

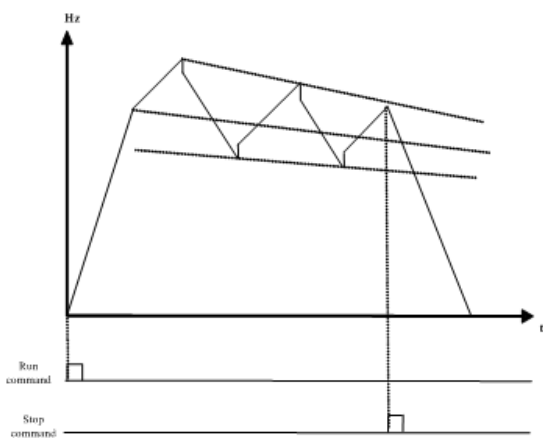

Fig 6-7

F236	Crawl-positioning	0: Disabled 1: Enabled	Mfr's value: 0
------	-------------------	------------------------	----------------

Crawl-positioning mode: when this mode is enabled, if inverter gets the signal of stop, full of yarn, broken of yarn, fixed length control, inverter will run to the frequency of crawl-positioning (F252). After the waiting time of crawl-positioning (F253), if inverter gets a positioning stop signal, inverter will stop (the positioning stop signal is invalid within crawl-positioning waiting time). If there is no positioning stop signal, inverter will stop automatically after max time of crawl-positioning time (F524). Note: if F524=0, inverter will not stop automatically.

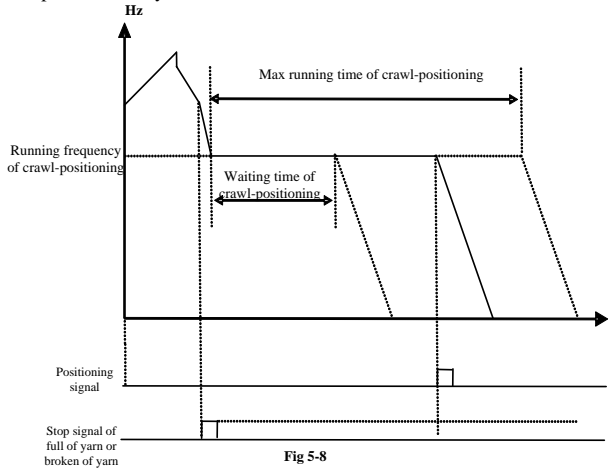

Fig 5-8

F237	Traverse signal source	0: Auto start 1: X terminal start	Mfr's value: 0
------	------------------------	-----------------------------------	----------------

·When F237=0 and F235≠0, inverter will run by traverse mode.

·When F237=1 and F235≠0, user should set DIX terminal as traverse start terminal, when this terminal is valid, traverse function is valid.

F238	Stop mode of length arrival	0: Stop the motor at fixed length 1: Stop the motor at fixed spindle radius 2: Non-stop at fixed length, it indicates full of yarn. 3: Fixed radius arrival, it indicates full of yarn.	Mfr's value: 0
F239	Traverse memory mode	0: Memory at the status of stop and power off 1: Only memory at the status of stop. 2: Only memory at the status of power off. 3: No memory.	Mfr's value: 0

F238=0 or 1, when fixed length or fixed radius is arrival, inverter will stop.

F238=2 or 3, when fixed length or fixed radius is arrival, multifunction terminals (DO1, DO2 and relay output terminal) will output signal. Inverter will not stop, and "ovEr" will be displayed in the panel.

F240	Preset frequency (Hz)	F112~F111	Mfr's value: 5.00
F241	Running time of preset frequency (S)	0~3000	Mfr's value: 0

F240 is used to define the inverter's operating frequency before entering traverse mode.

F241 is used to define the time when the inverter operates at pre-traverse frequency.

F242	Central frequency (Hz)	F243~F111	Mfr's value: 25.00
F243	Lower limit of central frequency (Hz)	F112~F242	Mfr's value: 0.50
F244	Descending rate of central frequency (Hz / S)	0.100~65.000	Mfr's value: 0.500
F247	Traverse amplitude setting mode	0: Relative to max frequency 1: Relative to central frequency	Mfr's value: 1
F248	Traverse amplitude (%)	0.00~100.00	Mfr's value: 10.0
F249	Jump frequency (%)	0.00~50.00	Mfr's value: 30.00
F250	Rising time of traverse (S)	0.1~3000	Mfr's value: 10.0
F251	Descending time of traverse (S)	0.1~3000	Mfr's value: 10.0
F252	Crawl-positioning frequency (Hz)	F112~F111	Mfr's value: 3.00
F253	Waiting time of crawl-positioning (S)	0.0~3000	Mfr's value: 5.0
F254	Max time of crawl-positioning (S)	0.0~3000	Mfr's value: 10.0

Please refer to Fig 6-6, 6-7 and 6-8.

If the lower limit frequency of traverse amplitude is lower than min frequency F112, then the lower limit of frequency of traverse amplitude turns to min frequency of inverter. If the upper limit frequency of traverse amplitude is higher than the max frequency F111, the frequency of traverse amplitude will turn to max frequency of inverter.

Jitter frequency is the percent of traverse amplitude, which is set by F249.

F257	Cumulative length (Km)	0.0~6500.0	Mfr's value: 0.0
F258	Actual length (Km)	0.000~65.000	Mfr's value: 0.000
F259	Setting length (Km)	0.000~65.000	Mfr's value: 0.000
F260	Pulse numbers of length sensor	0.01~650.0	Mfr's value: 1.00

In fixed length control mode, the function of F257~F260 is valid.

F262	Clear yarn broken signal	Setting range: 0: stop and refer to yarn broken signal 1: refer to yarn broken signal	Mfr's value: 0
------	--------------------------	---	----------------

When F262=0, after inverter stops, if there is no yarn broken signal, then clear yarn broken malfunction.

When F262=1, if there is no yarn broken signal, then clear yarn broken malfunction.

F264	Feedback channel of fixed radius	0: AI1 1: AI2	Mfr's value: 0
F265	Fixed-radius display value	0~10000	Mfr's value: 1000
F266	Output voltage at fixed radius mode (V)	0.00~10.00	Mfr's value: 5.00
F267	Voltage hysteresis when judging full of yarn signal is clear.	0.00~10.00	Mfr's value: 0.00

F265 is used to set the display value corresponding to analog max value.

F266 is used to set output voltage of fixed radius sensor when fixed radius is arrival.

·Voltage hysteresis is set by F267. For example: if F266=5.00, F267=0.30, only when the feedback voltage is lower than 4.70V, inverter will judge full of yarn signal clear.

E2000

F269	DI pre-alarm current	Read only	Mfr's value: read only
F270	DI pre-alarm current threshold (A)	0.01~6.00	Mfr's value: 0.50
F271	DI pre-alarm current delay time (S)	5~60	Mfr's value: 30

When the function of DI pre-alarm is valid, running current will be saved in F269, Which is pre-alarm current value and not be changed. If DI terminal is enabled again, and running current is higher than (DI pre-alarm current + DI pre-alarm current threshold), after delay time of F271, DO terminal will output pre-alarm signal, but inverter will not stop. When running current is lower than (DI pre-alarm current + DI pre-alarm current threshold), DO terminal will not output pre-alarm signal.

Note: when DI terminal is invalid or not in running state, this function is invalid.

F272	Delay time of broken yarn and intertwining yarn (S)	0.0~3000	0.0
------	---	----------	-----

The delay time after judging broken of yarn and intertwining yarn.

when broken of yarn, BRK1 is displayed. When full of yarn, BRK2 is displayed.

F275	Detect frequency value (Hz)	F112~F111	25.00
F276	Detect frequency width (Hz)	0.00~20.00	0.50
F277	Third Acceleration Time (S)	0.1-3000	Subject to inverter model
F278	Third Deceleration Time (S)		
F279	Fourth Acceleration Time (S)		
F280	Fourth Deceleration Time (S)		

When inverter runs to diction frequency set by F275, the multifunction terminal will output a signal.

6.3. Multifunctional Input and Output Terminals

6.3.1 Digital multifunctional output terminals

F300	Relay token output	Setting range: 0~59	Mfr's value: 1
F301	DO1 token output		Mfr's value: 14
F302	DO2 token output	Refer to table 6-2 for detailed instructions.	Mfr's value: 5

E2000 inverter has one multifunctional relay output terminal. Inverters of 30kW and below 30 kW have one multifunctional digital output terminals (without DO2 terminal), inverters above 30 kW have two multifunctional digital output terminals.

In water supply system, if the fixed mode or timing interchanging mode is selected, relay token output and DO1 token output is invalid.

Table 6-2 Instructions for digital multifunctional output terminal

Value	Function	Instructions
0	no function	Output terminal has no functions.
1	inverter fault protection	When inverter works wrong, ON signal is output.
2	over latent frequency 1	Please refer to instructions from F307 to F309.
3	over latent frequency 2	Please refer to instructions from F307 to F309.
4	free stop	Under free stop status, after stop command is given, ON signal is output until inverter completely stops.
5	In running status 1	Indicating that inverter is running and ON signal is output.
6	Reserved	Reserved
7	acceleration/deceleration time switchover	Indicating that inverter is in the status of acceleration/deceleration time switchover
8	Reaching the Set Count Value	This terminal will be "action" when inverter carries the external count instruction and count value reaches the set value of F314.
9	Reaching the Designated Count Value	This terminal will be "action" when inverter carries the external count instruction and count value reaches the set value of F315.
10	inverter overload pre-alarm	When inverter is in over current status, if the accumulation time is more than inverter's overload protection time * F704, inverter outputs ON signal. After over current disappears or OL1 is enable, the signal output will stop.
11	motor overload pre-alarm	When motor is in over current status, if the accumulation time is more than motor's overload protection time * F705, inverter outputs ON signal. After over current disappears or OL2 is enable, the signal output will stop.
13	Inverter is ready to run	When inverter is powered on. Protection function is not in action and inverter is ready to run, then ON signal is output.
14	In running status 2	Indicating that inverter is running and ON signal is output. When inverter is running at 0HZ, it seems as the running status, and ON signal is output.
15	frequency arrival output	Indicating inverter runs to the setting target frequency, and ON signal is output. See F312.
16	overheat pre-alarm	When testing temperature reaches 80% of setting value, ON signal is output. When overheat protection occurs or testing value is lower than 80% of setting value, ON signal stops outputting.

17	over latent current output	When output current of inverter reaches the setting overlantent current, ON signal is output. See F310 and F311.
18	Analog line disconnection protection	Indicating inverter detects analog input lines disconnection, and ON signal is output. Please refer to F741.
19	Under-load 1 pre-alarm	Please refer to FA26 and FA27.
20	Zero current detecting output	When inverter output current has fallen to zero current detecting value, and after the setting time of F755, ON signal is output. Please refer to F754 and F755.
21	Output controlled by communication address 2005H	1 means output is valid. 0 means output is invalid.
22	Output controlled by communication address 2006H	
23	Output controlled by communication address 2007H	
24	Watchdog output token	Output signal is valid when inverter trips into Err6.
25	DI Pre-alarm current	Indicating pre-alarm states of running current higher than pre-alarm current (F269+F270)
26	Communication reset	When faults occur, inverter will be reset by Modbus writing 9 to 0x2000.
28	Dormancy	When inverter enters into dormancy status, ON signal output.
30	General pump is running	Indicating some general pumps are running.
31	Converter pump is running	Indicating some converter pumps are running.
32	Over-limit pressure token	Indicating the max limit value when PID adjusting is valid and negative feedback is selected, and feedback pressure is higher than max pressure set by F503
35	Stop signal of yarn full, yarn broken, yarn intertwining and stop inverter by manual	Indicating stop signal of yarn full, yarn broken, yarn intertwining and stop inverter by manual
36	Full yarn signal	Indicating yarn is full.
37	Output signal of traverse rising	Indicating traverse is rising.
38	Traverse wave form output	Indicating inverter is in the traverse status.
39	Yarn frequency detected	This function is valid when it is higher than yarn frequency, or else it is invalid.
42	The second motor token output	Indicating the current motor is the second motor.
43	Communication timeout 2	When F907>0, and receiving the previous data, if after the time set by F907, the next data is not received, inverter will output communication timeout signal. The timeout signal will be cleared by this terminal, and after receiving correct data, inverter will accumulate time again.
45	Token output when lower than setting temperature	When temperature is lower or equal to 0°C, token output signal is valid. When temperature is higher than 0°C+2°C, token output is invalid.
55	Under load	When FA77=2 or 3, when inverter is in the process of under load, ON signal is output.
59	oPEn	When drive trips into oPEn, the terminal is valid.

F303 DO output types selection

Setting range: 0: level output 1 : pulse output

Mfr's value: 0

- When level output is selected, all terminal functions in table 6-2 can be defined by F301.
- When pulse output is selected, DO1 can be defined as high-speed pulse output terminal. The max pulse frequency is 100KHz. The related function codes are F449、F450、F451、F452、F453.

F304	S curve beginning stage proportion (%)	Setting range: 2.0~50.0	30.0
F305	S curve ending stage proportion (%)	Setting range: 2.0~50.0	30.0
F306	Accel/decel mode	Setting range: 0: Straight-line 1: S curve	0

Please refer to Fig 5-9 about S curve accel/decel:

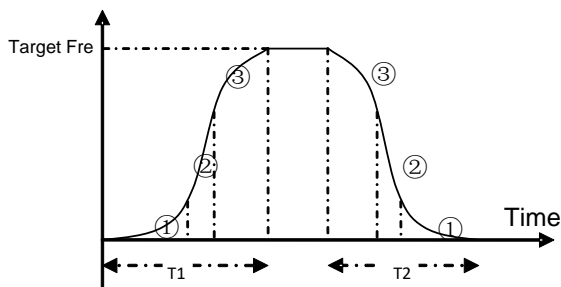

Fig 6-9 S curve acceleration /deceleration

T1 is the acceleration time from present frequency to target frequency.

T2 is the deceleration time from present frequency to target frequency.

During the acceleration process, in the ① stage, the acceleration slope is bigger gradually, in the ② stage, the acceleration slope is constant, in the ③ stage, the acceleration slope is weaker gradually.

F307	Characteristic frequency 1 (Hz)	Setting range: F112~F111	Mfr's value: 10
F308	Characteristic frequency 2 (Hz)		Mfr's value: 50
F309	Characteristic frequency width (%)	Setting range: 0~100	Mfr's value: 50

When F300=2, 3, F301=2, 3 and F302=2, 3 and token characteristic frequency is selected, this group function codes set characteristic frequency and its width. For example: setting F301=2, F307=10, F309=10, when frequency is higher than F307, DO1 outputs ON signal. When frequency is lower than $(10-10*10\%) = 9\text{Hz}$, DO1 outputs OFF signal.

F310	Characteristic current (A)	Setting range: 0~5000.0	Mfr's value: Rated current
F311	Characteristic current width (%)	Setting range: 0~100	Mfr's value: 10

When F300=17 and F301=17 and F302=17 and token characteristic current is selected, this group function codes set characteristic current and its width.

For example: setting F301=17, F310=100, F311=10, when inverter current is higher than F310, DO1 outputs ON signal. When inverter current is lower than $(100-10*10\%) = 90\text{A}$, DO1 outputs OFF signal.

F312	Frequency arrival threshold (Hz)	Setting range: 0.00~5.00	Mfr's value: 0.00
------	----------------------------------	--------------------------	-------------------

When F300=15 and F301=15, threshold range is set by F312.

For example: when F301=15, target frequency is 20HZ and F312=2, the running frequency reaches $20.00 \pm 2.00\text{Hz}$, ON signal is output by DO1.

F313	Count frequency divisions	Setting range: 1~65000	Mfr's value: 1
F314	Set count value	Setting range: F315~65000	Mfr's value: 1000
F315	Designated count value	Setting range: 1~F314	Mfr's value: 500

Count frequency divisions refer to the ratio of actual pulse input and inverter's count times, i.e.,

$$\text{Inverter's Count Times} = \frac{\text{Actual Pulse Input}}{\text{Count Frequency Division}}$$

e.g. when $F313=3$, inverter will count once for every 3 inputs of external pulse.

Set count values refer to a count width pulse output by the output terminal (DO1 terminal or relay) programmed with "reaching the set count values" function when a certain number of pulses are input from DI1. Count will restart after the count value reaches "set times".

As shown in Fig 6-10: if $F313=1$, $F314=8$, $F301=8$, DO1 will output an instruction signal when DI1 inputs the 8th pulse.

Designated count values refer to a pulse output by the output terminal (DO1 or RELAY terminal) programmed with "reaching the set count values" function when a certain number of pulses are input from DI1, until count value reaches the "set times".

As shown in Fig 6-10: if $F313=1$, $F314=8$, $F315=5$, $F300=9$, relay will output an instruction signal when DI1 inputs the 5th pulse, relay will output an instruction signal until reaching "set count times 8".

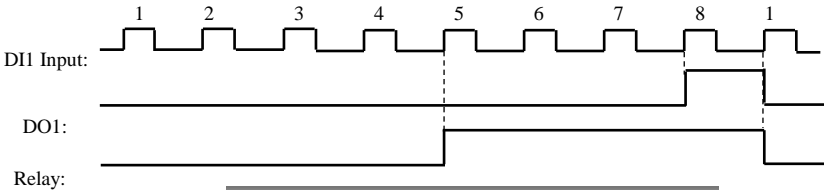

Fig 6-10 Set Count times & Designated Count Times

6.3.2 Digital multifunctional input terminals

F316 DI1 terminal function setting	Setting range: 0: no function; 1: running terminal; 2: stop terminal;	Mfr's value: 11
F317 DI2 terminal function setting	3: multi-stage speed terminal 1; 4: multi-stage speed terminal 2; 5: multi-stage speed terminal 3; 6: multi-stage speed terminal 4;	Mfr's value: 9
F318 DI3 terminal function setting	7: reset terminal; 8: free stop terminal; 9: external emergency stop terminal;	Mfr's value: 15
F319 DI4 terminal function setting	10: acceleration/deceleration forbidden terminal; 11: forward run jogging; 12: reverse run jogging;	Mfr's value: 16
F320 DI5 terminal function setting	13: UP frequency increasing terminal; 14: DOWN frequency decreasing terminal; 15: "FWD" terminal;	Mfr's value: 7
F321 DI6 terminal function setting	16: "REV" terminal; 17: three-line type input "X" terminal;	Mfr's value: 8

F322 DI7 terminal function setting	18: acceleration/deceleration time switchover 1; 19: Reserved;	Mfr's value: 0
F323 DI8 terminal function setting	20: switchover between speed and torque 21: frequency source switchover terminal; 22: Count input terminal: 23: Count reset terminal 24: clear traverse status 25: Traverse operating mode is valid. 26: yarn broken 27: intertwining yarn 28: crawl-positioning signal 29: clear actual yarn length and traverse status 30: Water lack signal; 31: Signal of water 32: Fire pressure switchover; 33: Emergency fire control 34: Acceleration / deceleration switchover 2 37: Common-open PTC heat protection 38: Common-close PTC heat protection 41: DI pre-alarm current enable 42: oPEn protection terminal. 49: PID paused 51: Motor switchover 53: Watchdog 54: Frequency reset 60: Communication timeout 2 61: Start-stop terminal	Mfr's value: 0

This parameter is used for setting the corresponding function for multifunctional digital input terminal.

Both free stop and external emergency stop of the terminal have the highest priority.

When pulse given is selected, DI1 terminal is set as pulse signal input terminal automatically.

Note: 30 kW inverter and below 22kW has 6 multifunctional digital input terminals DI1~DI6.

Table 6-3 Instructions for digital multifunctional input terminal

Value	Function	Instructions
0	No function	Even if signal is input, inverter will not work. This function can be set by undefined terminal to prevent mistake action.
1	Running terminal	When running command is given by terminal or terminals combination and this terminal is valid, inverter will run. This terminal has the same function with "run" key in keypad.
2	Stop terminal	When stop command is given by terminal or terminals combination and this terminal is valid, inverter will stop. This terminal has the same function with "stop" key in keypad.
3	Multistage speed terminal 1	15-stage speed is realized by combination of this group of terminals. See table 5-6.
4	Multistage speed terminal 2	
5	Multistage speed terminal 3	
6	Multistage speed terminal 4	
7	Reset terminal	This terminal has the same function with "reset" key in keypad. Long-distance malfunction reset can be realized by this function.
8	Free stop terminal	Inverter closes off output and motor stop process is not controlled by inverter. This mode is often used when load has big inertia or there are no requirements for stop time. This mode has the same function with free stop of F209.

9	External emergency stop terminal	When external malfunction signal is given to inverter, malfunction will occur and inverter will stop.
10	Acceleration/deceleration forbidden terminal	Inverter will not be controlled by external signal (except for stop command), and it will run at the current output frequency.
11	forward run jogging	Forward jogging running and reverse jogging running. Refer to F124, F125 and F126 for jogging running frequency, jogging acceleration/deceleration time.
12	reverse run jogging	
13	UP frequency increasing terminal	When frequency source is set by digital given, the setting frequency can be adjusted which rate is set by F211.
14	DOWN frequency decreasing terminal	
15	“FWD” terminal	When start/stop command is given by terminal or terminals combination, running direction of inverter is controlled by external terminals.
16	“REV” terminal	
17	Three-line input “X” terminal	“FWD”、“REV”、“CM” terminals realize three-line control. See F208 for details.
18	acceleration/deceleration time switchover I	Please refer to Table 5-4.
19	Reserved	Reserved
20	Reserved	Reserved
21	frequency source switchover terminal	When F207=2, main frequency source and accessory frequency source can be switched over by frequency source switching terminal. When F207=3, X and (X + Y) can be switched over by frequency source switching terminal.
22	Count input terminal	Built-in count pulse input terminal. Note: when PID source is pulse input, please set F316 to 22.
23	Count reset terminal	Reset terminal count value to zero.
24	clear traverse status	When this terminal is valid, traverse status will be cleared in the stop status. After inverter runs again, the traverse process will be repeated again.
25	Traverse operating mode is valid	When F235≠0 and F237=1, this terminal is used to control start/stop of traverse operating mode. If inverter is in the running status and this terminal is valid, traverse operating mode starts.
26	yarn broken	In the mode of traverse operating, if this terminal is valid, inverter will stop. If crawl-positioning function is valid, inverter will run to crawling frequency, and positioning, inverter will stop. When this terminal is invalid, inverter will run normally.
27	intertwining yarn	
28	crawl-positioning signal	During the process of crawl-positioning and after the waiting time F253, if the terminal is valid, inverter will stop.
29	clear actual yarn length and traverse status	This terminal is used to clear actual yarn length and traverse status.
30	Water lack signal	When PID control is valid and FA26=1, this function is valid. While lack of water, inverter will be in the protection state.
31	Signal of water	When PID control is valid and FA26=1, this function is valid. If water is enough, inverter will reset automatically.
32	Fire pressure switchover	When PID control is valid and this terminal is valid, the setting value of PID switches into fire pressure given (FA58).
33	Emergency fire control	When emergency fire mode (FA59) is valid, inverter will be in emergency fire mode.

34	Acceleration / deceleration switchover 2	Please refer to Table 5-4.
37	Common-open PTC heat protection	When this function is valid, common-open heat relay is externally connected. When common-open contact is closed and inverter is in the running status, inverter will trip into OHI.
38	Common-close PTC heat protection	When this function is valid, common-close heat relay is externally connected. When common-close contact is open and inverter is in the running status, inverter will trip into OHI.
41	DI pre-alarm current enable	When this function is valid, inverter will test running current.
49	PID paused	PID adjustment is invalid temporarily.
51	Motor switchover	When FE00=2 and this function is valid, switching to the second motor.
53	Watchdog	During the time set by F326 elapses without an impulse being registered, inverter will trip into Err6, and inverter will stop according to stop mode set by F327.
54	Frequency reset	If the function is valid, target frequency will change to the value set by F113.
60	Communication timeout 2	When F907>0, and receiving the previous data, if after the time set by F907, the next data is not received, inverter will output communication timeout signal. The timeout signal will be cleared by this terminal, and after receiving correct data, inverter will accumulate time again.
61	Start-stop terminal	When the function is invalid, it is stop terminal. When the function is valid, it is start terminal.

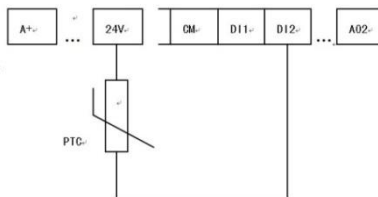

Fig 6-6 PTC heat protection

When the coding switch is in the end of “NPN”, PTC resistor should be connected between CM and DIx terminal. When the coding switch is in the end of “PNP”, PTC resistor should be connected between DIx and 24V. The recommended resistor value is 16.5K.

Because the precision of external PTC has some differences with optocoupler consistency, protection value precision will be bad, heat protection relay is suggested to be used.

Table 6-4 Accel/decel selection

Accel/decel switchover 2 (34)	Accel/decel switchover 1 (18)	Present accel/decel time	Related parameters
0	0	The first accel/decel time	F114, F115
0	1	The second accel/decel time	F116, F117
1	0	The third accel/decel time	F277, F278
1	1	The fourth accel/decel time	F279, F280

Table 6-6 Instructions for multistage speed

K4	K3	K2	K1	Frequency setting	Parameters
0	0	0	0	None	None
0	0	0	1	Multi-stage speed 1	F504/F519/F534/F549/F557/F565
0	0	1	0	Multi-stage speed 2	F505/F520/F535/F550/F558/F566
0	0	1	1	Multi-stage speed 3	F506/F521/F536/F551/F559/F567
0	1	0	0	Multi-stage speed 4	F507/F522/F537/F552/F560/F568
0	1	0	1	Multi-stage speed 5	F508/F523/F538/F553/F561/F569
0	1	1	0	Multi-stage speed 6	F509/F524/F539/F554/F562/F570
0	1	1	1	Multi-stage speed 7	F510/F525/F540/F555/F563/F571
1	0	0	0	Multi-stage speed 8	F511/F526/F541/F556/F564/F572
1	0	0	1	Multi-stage speed 9	F512/F527/F542/F573
1	0	1	0	Multi-stage speed 10	F513/F528/F543/F574
1	0	1	1	Multi-stage speed 11	F514/F529/F544/F575
1	1	0	0	Multi-stage speed 12	F515/F530/F545/F576
1	1	0	1	Multi-stage speed 13	F516/F531/F546/F577
1	1	1	0	Multi-stage speed 14	F517/F532/F547/F578
1	1	1	1	Multi-stage speed 15	F518/F533/F548/F579

Note: 1. K4 is multi-stage speed terminal 4, K3 is multi-stage speed terminal 3, K2 is multi-stage speed terminal 2, K1 is multi-stage speed terminal 1. And 0 stands for OFF, 1 stands for ON.

2. 0=OFF, 1=ON

3. The setting of this table is valid when F580=0.

F324 Free stop terminal logic	Setting range: 0: positive logic (valid for low level); 1: negative logic (valid for high level)	Mfr's value: 0
F325 External emergency stop terminal logic		Mfr's value: 0
F326 Watchdog time	Setting range: 0.0: Invalid 0.1~30000	Mfr's value: 10.0
F327 Stop mode	Setting range: 0: Free to stop 1: Deceleration to stop	Mfr's value : 0
F328 Terminal filtering times	Setting range: 1~100	Mfr's value: 10

When multi-stage speed terminal is set to free stop terminal (8) and external emergency stop terminal (9), terminal logic level is set by this group of function codes. When F324=0 and F325=0, positive logic and low level is valid, when F324=1 and F325=1, negative logic and high level is valid.

F329 Run command of start terminal	Setting range: 0: Valid 1: Invalid	Mfr's value: 0
------------------------------------	------------------------------------	----------------

When F329=0, after power on, if start terminals (running terminal, forward jogging, reverse jogging, FWD, REV, 3-line X input enable) is valid, inverter will start running directly.

When F329=1, after power on, if start terminals (running terminal, forward jogging, reverse jogging, FWD, REV, 3-line X input enable) is valid, inverter will start running after disconnect start terminal first and enable it again.

Diagnostics and simulation functions

F330 Diagnostics of DIX terminal		Read only
----------------------------------	--	-----------

F330 is used to display the diagnostics of DIX terminals.

Please refer to Fig 6-12 about the DIX terminals diagnostics in the first digitron.

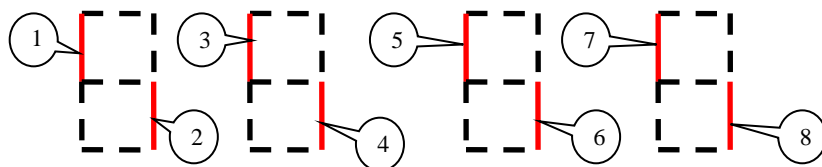

Fig 6-12 Status of digital input terminal

The dotted line means this part of digitron is red.

For example, in the first digitron, the upper part of digitron is red, it means DI1 terminal is invalid. The lower part of digitron is red, it means DI2 is valid. The four digitrons stands for the status of DI1-DI8 terminals

Please refer to Fig 6-13 about four-line LCD interface. The solid-line box and dotted-line box indicate the invalid and valid respectively.



Figure 6-13 Status of digital input terminals

Set F645=22, press "SET", switch interface by "FUN" key to display 8 boxes. Short connecting to DI1~DI8, terminals are valid if number turns from 0 to 1, and eight dotted-line boxes are displayed; Terminals are invalid if number does not turn to 1, and eight solid-line boxes are displayed.

If user wants to see the detailed status for each terminal, set the function code as F330, press "SET" to enter diagnosis interface, which is showed below.

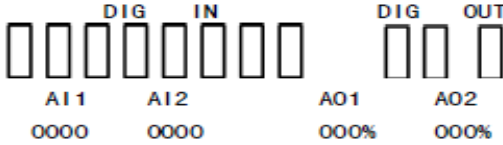

The first line indicates digital input, digital output; First eight boxes in the second line indicate the state of DI terminals, terminals from left to right are DI1~DI8, solid-line box is the state showed as above when terminal is invalid; Black box is displayed when terminal is valid. E.g. If all 8 terminals are valid, will be displayed.

The last three boxes represent the terminal output status of DO1, DO2 and relay, which display mode is the same as DI terminals. E.g. If 3 terminals are valid at same time, will be displayed.

The third line indicates the name of AI1, AI2 and AO1, AO2. The value displayed in fourth line correspond to the content of third line.

E.g. AI1 AI2 AO1 AO2
2010 0000 000% 000%

It means the value of AI1 is 2010, so are the rest three values.

After checking diagnosis interface, if user needs to exit interface, press “FUN” key to enter first-level menu.

Analog input monitoring, the value of analog is displayed by 0~4095.

F331Monitoring AI1		Read only
F332 Monitoring AI2		Read only
F333 Monitoring AI3		Read only

Relay/Digital output simulation

F335	Relay output simulation	Setting range: 0: Output active 1: Output inactive.	Mfr's value: 0
F336	DO1 output simulation		Mfr's value: 0
F337	DO2 output simulation		Mfr's value: 0

Take an example of DO1 output simulation, when inverter is in the stop status and enter F336, press the UP key, the DO1 terminal is valid. Relax the UP key, DO1 remains valid status. After quitting F336, DO1 will revert to initial output status.

4. Analog output simulation

F338	AO1 output simulation	Setting range: 0~4095	Mfr's value: 0
F339	AO2 output simulation	Setting range: 0~4095	Mfr's value: 0

When inverter is in the stop status, and enter F338 or F339, press the UP key, the output analog will increase, and when press the DOWN key, the output analog will decrease. If relax the key, analog output remains stable. After quitting the parameters, AO1 and AO2 will revert to initial output status.

F340 Selection of terminal negative logic	Setting range: 0: Invalid 2: DI2 negative logic 8: DI4 negative logic 32: DI6 negative logic 128: DI8 negative logic 1: DI1 negative logic 4: DI3 negative logic 16: DI5 negative logic 64: DI6 negative logic	Mfr's value: 0
---	---	----------------

For example: if user wants to set DI1 and DI4 to negative logic, please set F340=1+8=9.

F343	Delay time of DI1 ON	Setting range: 0.00~99.99	Mfr's value: 0.00
F344	Delay time of DI2 ON	Setting range: 0.00~99.99	Mfr's value: 0.00
F345	Delay time of DI3 ON	Setting range: 0.00~99.99	Mfr's value: 0.00
F346	Delay time of DI4 ON	Setting range: 0.00~99.99	Mfr's value: 0.00
F347	Delay time of DI5 ON	Setting range: 0.00~99.99	Mfr's value: 0.00
F348	Delay time of DI6 ON	Setting range: 0.00~99.99	Mfr's value: 0.00
F349	Delay time of DI7 ON	Setting range: 0.00~99.99	Mfr's value: 0.00
F350	Delay time of DI8 ON	Setting range: 0.00~99.99	Mfr's value: 0.00
F351	Delay time of DI1 OFF	Setting range: 0.00~99.99	Mfr's value: 0.00
F352	Delay time of DI2 OFF	Setting range: 0.00~99.99	Mfr's value: 0.00
F353	Delay time of DI3 OFF	Setting range: 0.00~99.99	Mfr's value: 0.00
F354	Delay time of DI4 OFF	Setting range: 0.00~99.99	Mfr's value: 0.00
F355	Delay time of DI5 OFF	Setting range: 0.00~99.99	Mfr's value: 0.00
F356	Delay time of DI6 OFF	Setting range: 0.00~99.99	Mfr's value: 0.00
F357	Delay time of DI7 OFF	Setting range: 0.00~99.99	Mfr's value: 0.00
F358	Delay time of DI8 OFF	Setting range: 0.00~99.99	Mfr's value: 0.00

F359	Stop command priority	Setting range: 0: Invalid 1: Valid	Mfr's value: 0
------	-----------------------	------------------------------------	----------------

When F359=1, if inverter get stop command when run command is valid, inverter will stop first. Inverter will start again only after disconnecting the start terminal first and connect it again.

F360	DO terminal negative logic	Setting range: 0: Invalid 1: DO1 negative logic 2: DO2 negative logic 4: Relay 1	Mfr's value: 0
------	----------------------------	---	----------------

If DO1 is negative logic, F360=1. If DO2 is negative logic, F360=2. If relay 1 is negative logic, F360=4. If DO1 and DO2 are negative logic, then F360=1+2=3..

6.4 Analog Input and Output

E2000 series inverters have 2 analog input channels and 2 analog output channels. AI3 input channel is inside input channel for potentiometer on the keypad panel.

F400	Lower limit of AI1 channel input (V)	Setting range: 0.00~F402	Mfr's value: 0.04
F401	Corresponding setting for lower limit of AI1 input	Setting range: 0~2.00	Mfr's value: 1.00
F402	Upper limit of AI1 channel input (V)	Setting range: F400~10.00	Mfr's value: 10.00
F403	Corresponding setting for upper limit of AI1 input	Setting range: 0.00 ~2.00	Mfr's value: 2.00
F404	AI1 channel proportional gain K1	Setting range: 0.0~10.0	Mfr's value: 1.0
F405	AI1 filtering time constant (S)	Setting range: 0.10~10.00	Mfr's value: 0.10

In the mode of analog speed control, sometimes it requires adjusting coincidence relation among upper limit and lower limit of input analog, analog changes and output frequency, to achieve a satisfactory speed control effect.

- Upper and lower limit of analog input are set by F400 and F402.
- For example: when F400=1, F402=8, if analog input voltage is lower than 1V, system judges it as 0. If input voltage is higher than 8V, system judges it as 10V (Suppose analog channel selects 0-10V). If Max frequency F111 is set to 50Hz, the output frequency corresponding to 1-8V is 0-50Hz.
- The filtering time constant is set by F405.

The greater the filtering time constant is, the more stable for the analog testing. However, the precision may decrease to a certain extent. It may require appropriate adjustment according to actual application.

- Channel proportional gain is set by F404.
- If 1V corresponds to 10Hz and F404=2, then 1V will correspond to 20Hz.
- Corresponding setting for upper / lower limit of analog input are set by F401 and F403.

If Max frequency F111 is 50Hz, analog input voltage 0-10V can correspond to output frequency from -50Hz to 50Hz by setting this group function codes. Please set F401=0 and F403=2, then 0V corresponds to -50Hz, 5V corresponds to 0Hz and 10V corresponds to 50Hz. The unit of corresponding setting for upper / lower limit of input is in percentage (%). If the value is greater than 1.00, it is positive; if the value is less than 1.00, it is negative. (e.g. F401=0.5 represents -50%).

If the running direction is set to forward running by F202, then 0-5V corresponding to the minus frequency will cause reverse running, or vice versa.

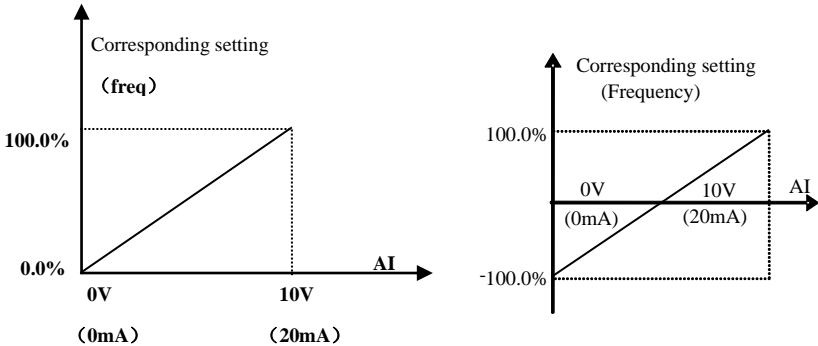
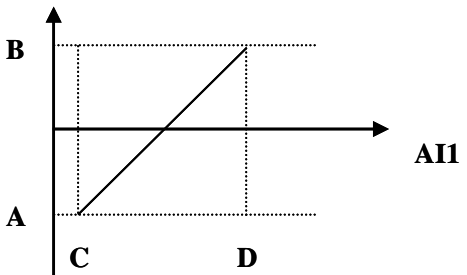

Fig 6-14 correspondence of analog input to setting

The unit of corresponding setting for upper / lower limit of input is in percentage (%). If the value is greater than 1.00, it is positive; if the value is less than 1.00, it is negative. (e.g. F401=0.5 represents -50%). The corresponding setting benchmark: in the mode of combined speed control, analog is the accessory frequency and the setting benchmark for range of accessory frequency which relates to main frequency is "main frequency X"; corresponding setting benchmark for other cases is the "max



frequency", as illustrated in the right figure:

A= (F401-1)* setting value

B= (F403-1)* setting value

C= F400 D= F402

F406	Lower limit of AI2 channel input (V)	Setting range: 0.00~F408	Mfr's value: 0.04
F407	Corresponding setting for lower limit of AI2 input	Setting range: 0.00~2.00	Mfr's value: 1.00
F408	Upper limit of AI2 channel input (V)	Setting range: F406~10.00	Mfr's value: 10.00
F409	Corresponding setting for upper limit of AI2 input	Setting range: 0.00~2.00	Mfr's value: 2.00
F410	AI2 channel proportional gain K2	Setting range: 0.0~10.0	Mfr's value: 1.0
F411	AI2 filtering time constant (S)	Setting range: 0.01~10.00	Mfr's value: 0.10
F412	Lower limit of AI3 channel input (V)	Setting range: 0.00~F414	Mfr's value: 0.05
F413	Corresponding setting for lower limit of AI3 input	Setting range: 0.00~2.00	Mfr's value: 1.00
F414	Upper limit of AI3 channel input (V)	Setting range: F412~10.00	Mfr's value: 10.00
F415	Corresponding setting for upper limit of AI3 input	Setting range: 0.00~2.00	Mfr's value: 2.00
F416	AI3 channel proportional gain K1	Setting range: 0.0~10.0	Mfr's value: 1.0
F417	AI3 filtering time constant (S)	Setting range: 0.01~10.00	Mfr's value: 0.10

The function of AI2 and AI3 is the same with AI1.

F418	AI1 channel 0Hz voltage dead zone (V)	Setting range: 0.00~1.00	Mfr's value: 0.00
F419	AI2 channel 0Hz voltage dead zone (V)	Setting range: 0.00~1.00	Mfr's value: 0.00
F420	AI3 channel 0Hz voltage dead zone (V)	Setting range: 0.00~1.00	Mfr's value: 0.00

Analog input voltage 0-5V can correspond to output frequency -50Hz-50Hz (2.5V corresponds to 0Hz) by setting the function of corresponding setting for upper / lower limit of analog input. The group function codes of F418, F419 and F420 set the voltage range corresponding to 0Hz. For example, when F418=0.5, F419=0.5 and F420=0.5, the voltage range from (2.5-0.5=2) to (2.5+0.5=3) corresponds to 0Hz. So if F418=N, F419=N and F420=N, then 2.5±N should correspond to 0Hz. If the voltage is in this range, inverter will output 0Hz. 0HZ voltage dead zone will be valid when corresponding setting for lower limit of input is less than 1.00. E2000 series inverters have two analog output channels.

F421 Panel selection	Setting range: 1: Local/ Remote keypad panel auto switch 2: local keypad + remote control keypad	Mfr's value: 1
F422 Potentiometer selection	Setting range: 0: Potentiometer in local panel 1: Potentiometer in remote control panel	Mfr's value: 0

When F421 is set to 0, local keypad panel is working. When F421 is set to 1, remote control keypad panel is working, and local keypad panel will be invalid for saving energy.

F422 is used to select potentiometer, which is only suitable for LED keypad.

When F422 is set to 0, the potentiometer in local LED panel is valid. When F422 is set to 1, the potentiometer in remote LED keypad is valid.

The remote control panel is connected by 8-cores net cable.

F423 AO1 output range	Setting range: 0: 0~5V; 1: 0~10V or 0~20mA 2: 4~20mA	Mfr's value: 1
-----------------------	---	----------------

F424	AO1 lowest corresponding frequency (Hz)	Setting range: 0.0~F425	Mfr's value: 0.05
F425	AO1 highest corresponding frequency (Hz)	Setting range: F424~F111	Mfr's value: 50.00
F426	AO1 output compensation (%)	Setting range: 0~120	Mfr's value: 100

· AO1 output range is selected by F423. When F423=0, AO1 output range selects 0-5V, and when F423=1, AO1 output range selects 0-10V or 0-20mA. When F423=2, AO1 output range selects 4-20mA (When AO1 output range selects current signal, please turn the switch J5 to "I" position.)

· Correspondence of output voltage range (0-5V or 0-10V) to output frequency is set by F424 and F425. For example, when F423=0, F424=10 and F425=120, analog channel AO1 outputs 0-5V and the output frequency is 10-120Hz.

· AO1 output compensation is set by F426. Analog excursion can be compensated by setting F426.

F427	AO2 output range	Setting range: 0: 0~20mA; 1: 4~20 mA	Mfr's value: 0
F428	AO2 lowest corresponding frequency (Hz)	Setting range: 0.0~F429	Mfr's value: 0.05
F429	AO2 highest corresponding frequency (Hz)	Setting range: F428~F111	Mfr's value: 50.00
F430	AO2 output compensation (%)	Setting range: 0~120	Mfr's value: 100

The function of AO2 is the same as AO1, but AO2 will output current signal, current signal of 0-20mA and 4-20mA could be selected by F427.

F431	AO1 analog output signal selecting	Setting range: 0: Running frequency; 1: Output current; 2: Output voltage; 3: AI1 4: AI2 5: Input pulse 6: Output torque 7: Given by PC/PLC 8: Target frequency 9: Actual speed 10: Output torque 2 11: Reserved 12: Output power 13: DO2 output	Mfr's value: 0
F432	AO2 analog output signal selecting		Mfr's value: 1

· Token contents output by analog channel are selected by F431 and F432. Token contents include running frequency, output current and output voltage.

· When output current is selected, analog output signal is from 0 to twofold rated current.

· When output voltage is selected, analog output signal is from 0V to rated output voltage.

· When actual speed is selected, the speed is actual speed in vector control mode. In the other mode, the speed is synchronous speed.

· 6: Output torque: indicating output torque absolute value. The max value of analog is corresponding to 3 times of rated torque(F436).

· 10: output torque 2: when output torque is higher than 0, indicating present torque. When output torque is lower than 0, there is no output. The max value of analog is corresponding to 3 times of rated torque(F436).

· 13: DO2 output: F302=1, F431=13, F423=1, and analog coding switch turns to voltage, after fault occurs,

AO1 output 10V. After the fault is reset, AO1 output 0V. if coding switch turns to current, AO1 will output 0mA or 20mA.

F433	Corresponding current for full range of external voltmeter	Setting range: 0.01~5.00	Mfr's value: 2.00
F434	Corresponding current for full range of external ammeter		Mfr's value: 2.00

· In case of F431=1 and AO1 channel for token current, F433 is the ratio of measurement range of external voltage type ammeter to rated current of the inverter.

· In case of F432=1 and AO2 channel for token current, F434 is the ratio of measurement range of external current type ammeter to rated current of the inverter.

For example: measurement range of external ammeter is 20A, and rated current of the inverter is 8A, then, $F433=20/8=2.50$.

F435 Corresponding multiple of rated power for output max analog value	Setting range: 0.01~3.00	Mfr's value:2.00
--	-----------------------------	------------------

Analog output range is token as 0.01~3.00 times of torque power.

F436 Corresponding current multiple of rated torque for output max analog value	Setting range: 0.01~3.00	Mfr's value: 3.00
---	-----------------------------	-------------------

In vector control mode, analog is 0.01~3.00 times of torque current.

F438 Input signal of AI1 channel	Setting range: 0: voltage 1: current	Mfr's value: 0
F439 Input signal of AI2 channel	Setting range: 0: voltage 1: current	Mfr's value: 1

When F438=0, AI1 channel is voltage signal input, when F438=1, AI1 channel is current signal input.

When F439=0, AI1 channel is voltage signal input, when F439=1, AI1 channel is current signal input.

The input signal should be matched with this parameter setting, and coding switch should be referred to Table 5-2 and 5-3.

6.5 Pulse input/output

F440 Min frequency of input pulse FI (KHz)	Setting range: 0.00~F442	Mfr's value: 0.00
F441 Corresponding setting of FI min frequency	Setting range:0.00~F443	Mfr's value: 1.00
F442 Max frequency of input pulse FI (KHz)	Setting range: F440~100.00	Mfr's value: 10.00
F443 Corresponding setting of FI max frequency	Setting range: Max (1.00, F441) ~2.00	Mfr's value: 2.00
F445 Filtering constant of FI input pulse	Setting range: 0~1000	Mfr's value: 0
F446 FI channel 0Hz frequency dead zone (KHz)	Setting range: 0~F442 (Positive-Negative)	Mfr's value: 0.00
F448 FI proportion gain	Setting range:0.001~2.000	Mfr's value: 1.000

Min frequency of input pulse is set by F440 and max frequency of input pulse is set by F442.

For example: when F440=0K and F442=10K, and the max frequency is set to 50Hz, then input pulse frequency 0-10K corresponds to output frequency 0-50Hz.

Filtering time constant of input pulse is set by F445.

The greater the filtering time constant is, the more steady pulse measurement, but precision will be lower, so please adjust it according to the application situation.

Corresponding setting of min frequency is set by F441 and corresponding setting of max frequency is set by F443.

When the max frequency is set to 50Hz, pulse input 0-10K can correspond to output frequency -50Hz-50Hz by setting this group function codes. Please set F441 to 0 and F443 to 2, then 0K corresponds to -50Hz, 5K corresponds to 0Hz, and 10K corresponds to 50Hz. The unit of corresponding setting for max/min pulse frequency is in percentage (%). If the value is greater than 1.00, it is positive; if the value is less than 1.00, it is negative.

If the running direction is set to forward running by F202, 0-5K corresponding to the minus frequency will cause reverse running, or vice versa.

-0 Hz frequency dead zone is set by F446.

Input pulse 0-10K can correspond to output frequency -50Hz-50Hz (5K corresponds to 0Hz) by setting the function of corresponding setting for max/min input pulse frequency. The function code F446 sets the input pulse range corresponding to 0Hz. For example, when F446=0.5, the pulse range from (5K-0.5K=4.5K) to (5K+0.5K=5.5K) corresponds to 0Hz. So if F446=N, then $5 \pm N$ should correspond to 0Hz. If the pulse is in this range, inverter will output 0Hz.

0Hz voltage dead zone will be valid when corresponding setting for min pulse frequency is less than 1.00.

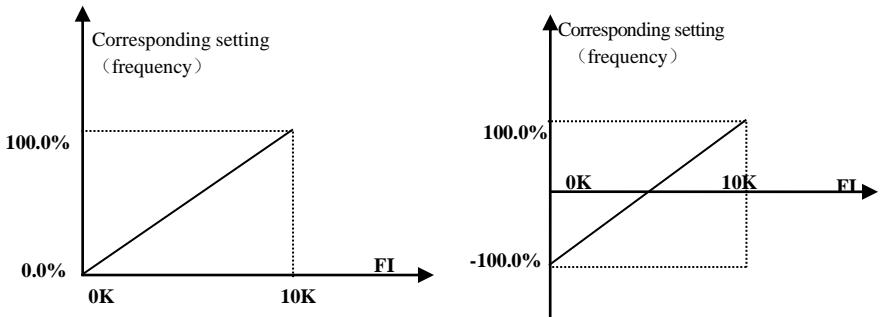

Fig 6-15 correspondence of pulse input and setting

The unit of corresponding setting for max/min input pulse frequency is in percentage (%). If the value is greater than 1.00, it is positive; if the value is less than 1.00, it is negative. (e.g. F441=0.5 represents -50%). The corresponding setting benchmark: in the mode of combined speed control, pulse input is the accessorial frequency and the setting benchmark for range of accessorial frequency which relates to main frequency (F205=1) is “main frequency X”; corresponding setting benchmark for other cases is the “max frequency”, as illustrated in the right figure:

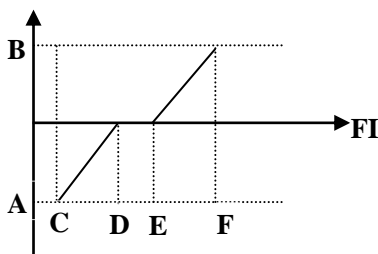

Fig 6-16 relationship between pulse input and setting value

A= (F441-1)*setting benchmark

B= (F443-1)*setting benchmark

C= F440 F= F442 (E-D)/2=F446

F449 Max frequency of output pulse FO (KHz)	Setting range: 0.00~100.00	Mfr's value: 10.00
F450 Zero bias coefficient of output pulse frequency (%)	Setting range: 0.0~100.0	Mfr's value: 0.0
F451 Frequency gain of output pulse	Setting range: 0.00~10.00	Mfr's value: 1.00
F453 Output pulse signal	Setting range: 0: Running frequency 1: Output current 2: Output voltage 3: AI1 4: AI2 5: Input pulse 6: Output torque 7: Given by PC/PLC 8: Target frequency	Mfr's value: 0

· When DO1 is defined as high-speed pulse output terminal, the max frequency of output pulse is set by F449.

If “b” stands for zero bias coefficient, “k” stands for gain, “Y” stands for actual output of pulse frequency and “x” stands for standard output, then $Y=Kx+b$.

Standard output x is the token value corresponding to output pulse min/max frequency, which range is from zero to max value.

·100 percent of zero bias coefficient of output pulse frequency corresponds to the max output pulse frequency (the set value of F449.)

Frequency gain of output pulse is set by F451. User can set it to compensate the deviation of output pulse.

Output pulse token object is set by F453. For example: running frequency, output current and output voltage, etc.

·When output current is displayed, the range of token output is 0-2 times of rated current.

·When output voltage is displayed, the range of token output is from 0-1.0 times of rated output voltage.

F460 AI1 channel input mode	Setting range: 0: straight line mode 1: folding line mode	Mfr's value: 0
F461 AI2 channel input mode	Setting range: 0: straight line mode 1: folding line mode	Mfr's value: 0
F462 AI1 insertion point A1 voltage value (V)	Setting range: F400~F464	Mfr's value: 2.00
F463 AI1 insertion point A1 setting value	Setting range: 0.00~2.00	Mfr's value: 1.20
F464 AI1 insertion point A2 voltage value (V)	Setting range: F462~F466	Mfr's value: 5.00
F465 AI1 insertion point A2 setting value	Setting range: 0.00~2.00	Mfr's value: 1.50

F466	AI1 insertion point A3 voltage value (V)	Setting range: F464~F402	Mfr's value: 8.00
F467	AI1 insertion point A3 setting value	Setting range: 0.00~2.00	Mfr's value: 1.80
F468	AI2 insertion point B1 voltage value (V)	Setting range: F406~F470	Mfr's value: 2.00
F469	AI2 insertion point B1 setting value	Setting range: 0.00~2.00	Mfr's value: 1.20
F470	AI2 insertion point B2 voltage value (V)	Setting range: F468~F472	Mfr's value: 5.00
F471	AI2 insertion point B2 setting value	Setting range: 0.00~2.00	Mfr's value: 1.50
F472	AI2 insertion point B3 voltage value (V)	Setting range: F470~F412	Mfr's value: 8.00
F473	AI2 insertion point B3 setting value	Setting range: 0.00~2.00	Mfr's value: 1.80

When analog channel input mode selects straight-line, please set it according to the parameters from F400 to F429. When folding line mode is selected, three points A1(B1), A2(B2), A3(B3) are inserted into the straight line, each of which can set the according frequency to input voltage. Please refer to the following figure:

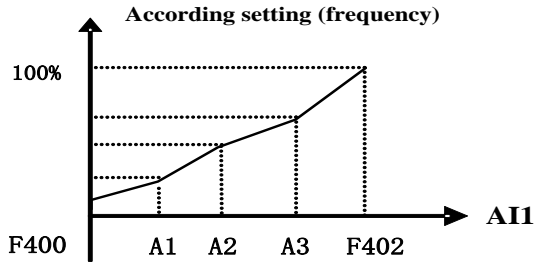

Fig 6-17 Folding analog with setting value

F400 and F402 are lower/upper limit of analog AI1 input. When F460=1, F462=2.00V, F463=1.4, F111=50, F203=1, F207=0, then A1 point corresponding frequency is $(F463-1) * F111=20\text{Hz}$, which means 2.00V corresponding to 20Hz. The other points can be set by the same way.

AI2 channel has the same setting way as AI1.

F475	AO1 deviation compensation	Setting range: 0~5.00	Mfr's value: 1.00
F476	AO2 deviation compensation	Setting range: 0~5.00	Mfr's value: 1.00

F475 is the compensation of min current when AO1 is chosen as 4~20mA channel.

F476 is the compensation of min current when AO2 is chosen as 4~20mA channel.

F477	User-define speed control mode	Setting range: 0: Invalid 1: Valid	Mfr's value: 0
F478	Max limit of output frequency	Setting range: F113~F111	Mfr's value: 50.00

When F477=1, 3 kinds of control speed mode can be realized, $K1 * X - K2 * Y$, $K1 * X + K2 * Y - 5V$, $K1 * X + K2 * (Y - 5V)$.

For example: if main frequency is given by AI1, auxiliary frequency is given by AI2, $K1=3, K2=2$,

Speed control mode	F203	F204	F207	F221	F206	F111	F478	Remarks
$3 * AI1 - 2 * AI2$	1	2	5	-	67%	150.00	50.00	F206=(K2 ÷K1)*100 F111=K1*50.00 F478 is max value of output frequency.
$3 * AI1 + 2 * AI2 - 5V$	1	2	6	25%	67%	150.00	50.00	
$3 * AI1 + 2 * (AI2 - 5V)$	1	2	6	50%	67%	150.00	50.00	

Note: the 3 kinds of speed control mode are valid only when the source of main frequency and auxiliary

frequency are set according to F207.

6.6 Multi-stage Speed Control

The function of multi-stage speed control is equivalent to a built-in PLC in the inverter. This function can set running time, running direction and running frequency.

E2000 series inverter can realize 15-stage speed control and 8-stage speed auto circulating.

During the process of speed track, multi-stage speed control is invalid. After speed track is finished, inverter will run to target frequency according to the setting value of parameters.

F500 Stage speed type	Setting range: 0: 3-stage speed; 1: 15-stage speed; 2: Max 8-stage speed auto circulating	Mfr's value: 1
-----------------------	---	----------------

In case of multi-stage speed control (F203=4), the user must select a mode by F500. When F500=0, 3-stage speed is selected. When F500=1, 15-stage speed is selected. When F500=2, max 8-stage speed auto circulating is selected. When F500=2, "auto circulating" is classified into "2-stage speed auto circulating", "3-stage speed auto circulating", ... "8-stage speed auto circulating", which is to be set by F501.

Table 6-7 Selection of Stage Speed Running Mode

F203	F500	Mode of Running	Description
4	0	3-stage speed control	The priority in turn is stage-1 speed, stage-2 speed and stage-3 speed. It can be combined with analog speed control. If F207=4, "3-stage speed control" is prior to analog speed control.
4	1	15-stage speed control	It can be combined with analog speed control. If F207=4, "15-stage speed control" is prior to analog speed control.
4	2	Max 8-stage speed auto circulating	Adjusting the running frequency manually is not allowable. "2-stage speed auto circulating", "3-stage speed auto circulating", ... "8-stage speed auto circulating" may be selected through setting the parameters.
F501	Selection of Stage Speed Under Auto-circulation Speed Control		Setting range: 2~8 Mfr's value: 7
F502	Selection of Times of Auto-circulation Speed Control		Setting range: 0~9999 (when the value is set to 0, the inverter will carry out infinite circulating) Mfr's value: 0
F503	Status After Auto-circulation Running Finished.		Setting range: 0: Stop 1: Keep running at last-stage speed Mfr's value: 0

- If running mode is auto-circulation speed control (F203=4 and F500=2), please set the related parameters by F501~F503.
- That the inverter runs at the preset stage speed one by one under the auto-circulation speed control is called as "one time".
- If F502=0, inverter will run at infinite auto circulation, which will be stopped by "stop" signal.
- If F502>0, inverter will run at auto circulation conditionally. When auto circulation of the preset times is finished continuously (set by F502), inverter will finish auto-circulation running conditionally. When inverter keeps running and the preset times is not finished, if inverter receives "stop command", inverter will stop. If inverter receives "run command" again, inverter will automatically circulate by the setting time of F502.
- If F503=0, then inverter will stop after auto circulation is finished. If F503=1, then inverter will run at the speed of the last-stage after auto-circulation is finished as follows:
e.g., F501=3, then inverter will run at auto circulation of 3-stage speed;

F502=100, then inverter will run 100 times of auto circulation;

F503=1, inverter will run at the speed of the last stage after the auto-circulation running is finished.

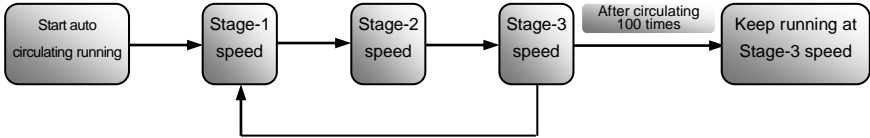

Figure 6-18 Auto-circulating Running

Then the inverter can be stopped by pressing “stop” or sending “stop” signal through terminal during auto-circulation running.

F504	Frequency setting for stage 1 speed (Hz)	Setting range: F112~F111	Mfr's value: 5.00
F505	Frequency setting for stage 2 speed (Hz)		Mfr's value: 10.00
F506	Frequency setting for stage 3 speed (Hz)		Mfr's value: 15.00
F507	Frequency setting for stage 4 speed (Hz)		Mfr's value: 20.00
F508	Frequency setting for stage 5 speed (Hz)		Mfr's value: 25.00
F509	Frequency setting for stage 6 speed (Hz)		Mfr's value: 30.00
F510	Frequency setting for stage 7 speed (Hz)		Mfr's value: 35.00
F511	Frequency setting for stage 8 speed (Hz)		Mfr's value: 40.00
F512	Frequency setting for stage 9 speed (Hz)		Mfr's value: 5.00
F513	Frequency setting for stage 10 speed (Hz)		Mfr's value: 10.00
F514	Frequency setting for stage 11 speed (Hz)		Mfr's value: 15.00
F515	Frequency setting for stage 12 speed (Hz)		Mfr's value: 20.00
F516	Frequency setting for stage 13 speed (Hz)		Mfr's value: 25.00
F517	Frequency setting for stage 14 speed (Hz)		Mfr's value: 30.00
F518	Frequency setting for stage 15 speed (Hz)		Mfr's value: 35.00
F519~F533	Acceleration time setting for the speeds from Stage 1 to Stage 15 (S)	Setting range: 0.1~3000	Subject to inverter model
F534~F548	Deceleration time setting for the speeds from Stage 1 to Stage 15 (S)	Setting range: 0.1~3000	
F549~F556	Running directions of stage speeds from Stage 1 to Stage 8 (S)	Setting range: 0: forward running; 1: reverse running	Mfr's value: 0
F573~F579	Running directions of stage speeds from stage 9 to stage 15 (S)	Setting range: 0: forward running; 1: reverse running	Mfr's value: 0
F557~564	Running time of stage speeds from Stage 1 to Stage 8 (S)	Setting range: 0.1~3000	Mfr's value: 1.0
F565~F572	Stop time after finishing stages from Stage 1 to Stage 8 (S)	Setting range: 0.0~3000	Mfr's value: 0.0
F580	Stage-speed mode	Setting range: 0: Stage speed mode 1	Mfr's value: 0

	1: Stage speed mode 2	
--	-----------------------	--

When F580=0, 0000 means invalid, 0001 means the first speed, 1111 means the 15th speed.

When F580=1, 0000 means the first speed, 0001 means the second speed, and so on. 1111 means invalid.

6.7 Auxiliary Functions

F600 DC Braking Function Selection	Setting range: 0: Invalid; 1: braking before starting; 2: braking during stopping; 3: braking during starting and stopping	Mfr's value: 0
F601 Initial Frequency for DC Braking (Hz)	Setting range: 0.20~50.00	Mfr's value: 1.00
F602 DC Braking efficiency before Starting	Setting range: 0~250 for 30kW and below 30kW	Mfr's value: 50
F603 DC Braking efficiency During Stop	0~200 for above 30kW	Mfr's value: 100
F604 Braking Lasting Time Before Starting (S)	Setting range: 0.0~30.00	Mfr's value: 0.50
F605 Braking Lasting Time During Stopping (S)		
F656 Time of DC braking when stop	Setting range: 0.00~30.00	Mfr's value: 0

·When F600=0, DC braking function is invalid.

·When F600=1, braking before starting is valid. After the right starting signal is input, inverter starts DC braking. After braking is finished, inverter will run from the initial frequency.

In some application occasion, such as fan, motor is running at a low speed or in a reverse status, if inverter starts immediately, OC malfunction will occur. Adopting “braking before starting” will ensure that the fan stays in a static state before starting to avoid this malfunction.

During braking before starting, if “stop” signal is given, inverter will stop by deceleration time.

When F600=2, DC braking during stopping is selected. After output frequency is lower than the initial frequency for DC braking (F601), DC braking will stop the motor immediately

During the process of braking during stopping, if “start” signal is given, DC braking will be finished and inverter will start.

If “stop” signal is given during the process of braking during stopping, inverter will have no response and DC braking during stopping still goes on.

·When jogging function is valid, the function of braking before starting set by F600 is valid, and the function of speed track is invalid.

·When jogging function is invalid and F613-1, the function of braking before starting is invalid.

·Parameters related to “DC Braking”: F601, F602, F603, F604, F605, interpreted as follows:

a. F601: Initial frequency of DC-braking. DC braking will start to work as inverter's output

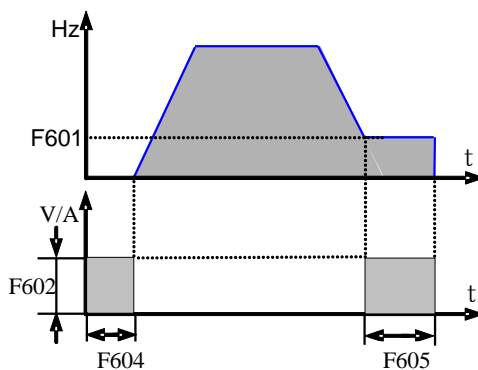

Figure 5-18 DC braking

- frequency is lower than this value.
- b. F602/F603: DC braking efficiency (the unit is the percentage of rated current). The bigger value will result in a quick braking. However, motor will overheat with too big value.
 - c. F604: Braking duration before starting. The time lasted for DC braking before inverter starts.
 - d. F605: Braking duration when stopping. The time lasted for DC braking while inverter stops.

Note: during DC braking, because motor does not have self-cool effect cause by rotating, it is in the state of easy over-heat. Please do not set DC braking voltage too high and do not set DC braking time to long. DC braking, as shown in Figure 6-19.

F606	DC brake selection	Setting range: 0: Voltage type 1: Current type	Mfr's value: 1
------	--------------------	--	----------------

F607	Selection of Stalling Adjusting Function	Setting range: 0: disable 1~2: Reserved 3: Voltage/current control 4: Voltage control 5: Current control	Mfr's value: 3
F608	Stalling Current Adjusting (%)	Setting range: 25~FC49	Mfr's value: 160
F609	Stalling Voltage Adjusting (%)	Setting range: 110~200	Mfr's value: S2/T2: 130 T3: 140
F610	Stalling Protection Judging Time (S)	Setting range: 0.0~3000	Mfr's value: 60.0

Initial value of stalling current adjusting is set by F608, when the present current is higher than rated current of inverter*F608, stalling current adjusting function is valid.

During the process of acceleration, if output current is higher than initial value of stalling current adjusting, inverter will not accelerate until the output current is lower than initial value of stalling current adjusting.

In case of stalling during stable speed running, the frequency will drop. In case of stalling during deceleration, the inverter will decrease the speed of deceleration. Until the output current is lower than initial value of stalling current adjusting, the inverter will return to normal deceleration.

F607 is used to set selection of stalling adjusting function.

Voltage control: when motor stops quickly or load changes suddenly, DC bus voltage will be high. Voltage control function can adjust deceleration time and output frequency to avoid OE.

When braking resistor or braking unit is used, please do not use voltage control function. Otherwise, the deceleration time will be changed.

Current control: when motor accelerates quickly or load changed suddenly, inverter may trip into OC. Current control function can adjust accel/decel time or decrease output frequency to control proper current value. It is only valid in VF control mode.

Note: (1) Voltage/current control is not suitable for lifting application.

(2) This function will change accel/decel time. Please use this function properly.

Initial value of stalling current adjusting is set by F608.

Initial value of stalling voltage adjusting is set by F609.

Stalling protection judging time is set by F610. When inverter starts stalling adjusting function and continues the setting time of F610, inverter will stop running and O.L1 protection occurs.

Note:

When F610=0, inverter will not stop running and display O.L1.

During stalling voltage adjusting, if customer presses STOP for 3 seconds, the inverter will be forced to stop

F611 Dynamic Braking threshold	Setting range: T3: 600~2000 S2/T2: 320~2000	Subject to inverter model
F612 Dynamic braking duty ratio (%)	Setting range: 0~100	Mfr's value: 100

Initial voltage of dynamic braking threshold is set by F611. When DC bus voltage is higher than the setting value of this function, dynamic braking starts, braking unit starts working. After DC bus voltage is lower than the setting value, braking unit stops working.

The value of F611 should be set according to input voltage. When the input voltage is 400V, F611 should be set to 700V, when input voltage is 460V, F611 should be set to 770V. The lower the dynamic braking threshold is, the better dynamic braking effect is. But the heat of braking resistor is more serious. The higher the dynamic braking threshold is, the worse dynamic braking effect is. And at the process of braking, inverter will easily trip to OE.

Dynamic braking duty ratio is set by F612, the range is 0~100%. The value is higher, the braking effect is better, but the braking resistor will get hot.

F620 Brake delay turn-off time	Setting range: 0.0 (brake not closed when stop) 0.1~3000	Mfr's value: 5.0
--------------------------------	--	------------------

F620=0, dynamic brake is not closed in stop status, it starts when PN voltage is higher than brake point; F620≠0, dynamic brake can proceed normally when inverter is running, the time set by F620 is the delay time after stop, then the dynamic brake closes automatically.

F613 Speed track	Setting range: 0: invalid 1: valid for induction motor 2: valid for induction motor at the first time 3: speed tracking mode 1 for PM motor 4: speed tracking mode 2 for PM motor	Mfr's value: 0
------------------	--	----------------

When F613=0, the function of speed track is invalid.

When F613=1, the function of speed track is valid for induction motor

After inverter tracks motor speed and rotating direction, inverter will start the rotating motor smoothly. This function is suitable for the situation of auto-starting after repowered on, auto-starting after reset, auto-starting when running command valid but direction signal lost and auto-starting when running command invalid.

When F613=2, the function is valid at the first time after inverter is power on.

When F613=3, it is suitable for low-inertia load of PM motor.

When F613=4, it is suitable for high inertia load of PM motor.

F614 Speed track mode	Setting range: 0: Speed track from frequency memory 1: Speed track from zero 2: Speed track from max frequency	Mfr's value: 0
-----------------------	---	----------------

When F614 is set to 0, inverter will track speed down from frequency memory.

When F614 is set to 1, inverter will track speed up from 0Hz.

When F614 is set to 2, inverter will track speed down from max frequency.

F615 Speed track rate	Setting range: 1~100	Mfr's value: 20
-----------------------	----------------------	-----------------

It is used to select the rotation velocity speed track when the rotation tracking restart mode is adopted. The

larger the parameter is, the faster the speed track is. But if this parameter is too large, it likely results in unreliable tracking.

F618 Delay time of speed track (S)	Setting range: 0.5~60.0	Mfr's value: 1.5
------------------------------------	-------------------------	------------------

F631 VDC adjustment selection	Setting range: 0: invalid 1: valid at stable running 2: reserved 3: valid at any time	Mfr's value: 0
F632 Target voltage of VDC adjusting (V)	Setting range: 100~2300	Mfr's value: subject to model
F633 frequency of VDC adjusting	Setting range: 0~100.00	Mfr's value: 5.0
F634 accelerating time of VDC adjusting	Setting range: 0.1~3000.00	Mfr's value: 0.1
F635 decelerating time of VDC adjusting	Setting range: 0.1~3000.00	Mfr's value: 0.1
F636 Proportion Gain of VDC adjusting	Setting range: 0.01~20.00	Mfr's value: 1.00
F637 integration gain of VDC adjusting	Setting range: 0~20.00	Mfr's value: 1.50

During motor running process, the PN bus voltage will raise suddenly because of load mutation, over-voltage protection will occur. VDC adjustment is used to control voltage steady by adjusting output frequency or reducing braking torque.

When F631=1, VDC only works at stable running

When F631=3, VDC works at any time.

F632: If the DC bus voltage is higher than the setting value of F632, VDC adjustor will automatically adjust the bus voltage same as the value of F632.

F633: VDC can adjust the max frequency. If inverter often alarm with OE error, customer can increase this value.

F634 and F635 is to adjust accelerating and decelerating time.

F636 and F637: The bigger of F636 and F637 is , the faster the response is.

Please disable the current limit and voltage limit function (F607=0 or 5) when customer use this function.

F638 Parameters copy enabled	Setting range: 0: Copy forbidden 1: Parameters download 1 (voltage level and power are totally same) 2: Parameters download 2 (without considering voltage level and power)	Mfr's value: 1
F639 Parameters copy code	Setting range: 2000~2999	Subject to version of software
F640 Parameter copy type	Setting range: 0: Copy all parameters 1: Copy parameters (except motor parameters from F801 to F810/F844)	Mfr's value: 1

Please refer to the user manual of parameters copy.

The fault is as following:

Code	Causes
Er71 Copy timeout	During copying process, there is no valid data during 3s.
Er72 Copy when running	Parameters copy when inverter is in the running status.
Er73 Copy without input password	Password is valid and user does not input password.
Er74 Copy between different models	If copy code, or voltage level or power is different, copy is forbidden.
Er75 Copy forbidden	Parameters copy when F638=0

F641 Inhibition of current oscillation at low frequency	Setting range: 0~100 0: Invalid	Subject to inverter model
---	------------------------------------	---------------------------

F641 is to inhibit the current oscillation at low frequency. The value of F641 is higher, the effect is better. When F641=0, inhibition function is invalid.

In the V/F control mode, if inhibition of current oscillation is valid, the following parameters are needed to be set.

(1) F106=2 (V/F control mode) and F137≤2;

(2) F613=0, the speed track function is invalid.

Note 1. When F641 is enable, one inverter can only drive one motor one time.

2. When F641 is enable, please set motor parameters (F801~F805, F844) correctly.

3. When this function is valid, and inverter runs without motor, output voltage may be unbalanced.

This is normal situation. After inverter runs with motor, output voltage will be balanced.

F643 Multi-functional key	Setting range: 0: Invalid 1: FWD jogging 2: REV jogging 3: Switchover between local/remote 4: Reverse run control	Mfr's value: 0
---------------------------	--	----------------

This function is valid only for remote control keypad.

When F643=3, after pressing multi-functional key and switchover, F200 and F201 will be changed to 3 automatically, which is MODBUS. If user wants to switch to keypad, F200 and F201 should be set again.

When F643=4, after pressing multi-functional keypad, inverter runs reversely. (this function is only valid for LED remote keypad.)

Note: when F643=4, no matter what the value of F202 is, after pressing run key, inverter will run forward, and after pressing multi-functional key, inverter will run reversely.

F644 Keypad copy enabled	Setting range: 0: Invalid 1: current macro parameter upload 2: current macro parameter download 3: user macro 1 upload 4: user macro 1 download 5: user macro 2 upload 6: user macro 2 download	Mfr's value: 0
--------------------------	---	----------------

·Keypad copy is only valid in LCD keypad.

In stop status, after saving user macro 1/2 parameters and setting F644=1, press “Run” key, inverter will enter parameter upload interface, all parameters of macro will be upload to keypad. When F644=3, user macro 1 parameters will be upload. When F644=5, user macro 2 parameters will be upload. After upload, when F644=2, parameters will be download to current user macro and cover the current parameters. When F644=4, parameters will be download to user macro1 and cover the parameters of macro 1. After setting F644=2, parameters will be download to user macro 2 and cover the parameters of macro 2.

F645 Status parameters selection	0	Running frequency
	1	Rotation speed
	2	Target speed
	3	Output current
	4	Output voltage
	5	DC bus voltage
	6	PID setting value
	7	PID feedback value
	8	Radiator temperature
	9	Count value
	10	Linear speed
	11	Channel for main frequency
	12	Main frequency
	13	Channel for accessorial frequency
	14	Accessorial frequency
	15	Target frequency
	16	Reserved
	17	Output torque
	18	Setting torque
	19	Motor power
	20	Output power
	21	Running status
	22	DI terminal status
	23	Output terminal status
	24	Stage speed of multi-stage speed
	25	AI1 input value
	26	AI2 input value
	28	Reserved
	29	Pulse input frequency
	30	Pulse output frequency
	31	AO1 output percent
	32	AO2 output percent
	33	Power on Hours
	34	Length
	35	Center frequency

For four-line LCD, the displayed contents at first two lines can be changed by setting F645.

F646 Backlight time of LCD (S)	Setting range: 0~100	Mfr's value: 100
F647 Language selection	Setting range: 0: Chinese 1: English 2: Deutsch	Mfr's value: 0

Change the duration of backlight by setting F646. F646=0, LCD light is always off; F646=100, LCD light is always on.

Change display language by setting F647, the default value is Chinese.

F649 Keypad selection	Setting range: 0: Automatic identification 1: LED remote keypad 2: LCD remote keypad	Mfr's value: 0
-----------------------	--	----------------

When F649=0, inverter will identify the keypad automatically.

When F649=1, only LED keypad is valid.

When F649=2, only LCD keypad is valid.

Note: when F421=2(Local+ remote keypad is valid). If LCD remote keypad is valid, the local keypad does not display.

F657 Instantaneous power failure selection	Setting range: 0: Invalid 1: non-stop after power failure 2: decelerate to stop after power failure	Mfr's value: 0
--	--	----------------

When F657=1, upon instantaneous power failure or sudden voltage dip, the function enables the inverter to compensate the DC bus voltage reduction with the load feedback energy by reducing the output frequency so as to keep the inverter running continuously.

When F657=2, upon instantaneous power failure or sudden voltage dip, the frequency will decrease rapidly and inverter will decelerate to stop.

Note: 1. F663 and F664 are related parameters, please increase them properly.

2: This function is not suitable for the application of heavy load and small inertial load.

F658 Voltage rally acceleration time (S)	Setting range: 0.0~3000 0.0: F114	Mfr's value: 0.0
F659 Voltage rally deceleration time (S)	Setting range: 0.0~3000 0.0: F115	Mfr's value: 0.0
F660 Action judging voltage at instantaneous power failure (V)	Setting range: 200~F661	Subject to inverter model
F661 Action stop voltage at instantaneous power failure (V)	Setting range: F660~1400	Subject to inverter model
F662 Instantaneous voltage recovery judging time(s)	Setting range: 0.00~10.00	Mfr's value: 0.30
F663 Instantaneous proportion coefficient Kp	Setting range: 0.00~10.00	Mfr's value: 0.25
F664 instantaneous integral coefficient Ki	Setting range: 0.00~10.00	Mfr's value: 0.30

F751 Instantaneous stop pretreatment enable	Setting range: 0: Invalid 1: Valid	Mfr's value: 0
---	---------------------------------------	----------------

Upon instantaneous power failure or sudden voltage dip, the DC bus voltage of the inverter reduces. The function enables the inverter to compensate the DC bus voltage reduction with the load feedback energy by reducing the output frequency so as to keep the inverter running continuously.

·The function is suitable for big inertia load, such as, fan and centrifugal pump.

The function is not suitable for the application which frequency is forbidden being decreased.

When the bus voltage resumes to normal, F658/F659 are used to set the accel/decel time when inverter runs to target frequency.

·When instantaneous function is valid, if PN voltage is lower than F660, instantaneous function works.

·When inverter is at instantaneous status, if PN voltage is higher than F661, the bus voltage remains to normal, inverter will work normally and run to target frequency.

F670 Voltage-limit current-limit adjustment coefficient	Setting range: 0.01~10.00	Mfr's value: 2.00
---	---------------------------	-------------------

Lower this factor properly if frequent over-voltage protection occurs in the process of deceleration; Increase the factor when deceleration is too slow.

F671 voltage source for V/F separation	Setting range: 0: F672 1: AI1 2: AI2 3: AI3 4: Communication setting 5: pulse setting 6: PID 7~10: reserved	Mfr's value: 0
F672 Voltage digital setting for V/F separation	Setting range: 0.00~100.00	Mfr's value: 100.0

F671 is 100% of the setting corresponds to the rated motor voltage.

· 0: digital setting, the output voltage is set by F672.

· 1: AI1; 2: AI2; 3: AI3;

The output voltage is set by analog.

· 4: Communication setting

The output voltage is set by PC/PLC, the communication address is 2009H, the given range is 0~10000, which means 0~100% of rated voltage.

· 5 pulse setting

The output voltage is set by external high-speed pulse. The input frequency of pulse corresponds to motor rated voltage.

· 6: PID

The output voltage is set by PID. PID adjustment corresponds to 100% of motor rated voltage. For details, please refer to PID parameters group.

F673 Lower limit of voltage at V/F separation (%)	Setting range: 0.00~F674	Mfr's value: 0.00
F674 Upper limit of voltage at V/F separation (%)	Setting range: F673~100.00	Mfr's value: 100.00

When the voltage is lower than F673, the voltage should equal to F673. When the voltage is higher than F674, the voltage should equal to F674.

F675 Voltage rise time of V/F separation (S)	Setting range: 0.0~3000.0	Mfr's value: 5.0
F676 Voltage decline time of V/F separation (S)	Setting range: 0.0~3000.0	Mfr's value: 5.0

F675 is the time required for the output voltage to rise from 0V to the rated motor voltage.

F676 is the time required for the output voltage to decline from the rated motor voltage to 0V.

F677 Stop mode at V/F separation	Setting range: 0: voltage and frequency declines to 0 according to respective time. 1: Voltage declines to 0 first 2: frequency declines to 0 first.	Mfr's value: 0
----------------------------------	---	----------------

When F677 = 0, voltage and frequency declines to 0 according to respective time, inverter will stop when frequency declines to 0.

When F677 = 1, voltage will decline to 0 at first. After voltage is 0, frequency will decline to 0.

When F677 = 2, frequency will decline to 0 at first. After frequency is 0, voltage will decline to 0.

F678 Judgment voltage at V/F separation	Setting range: 0: invalid 1: auto judgment	Mfr's value: 0
F679 Voltage switch point at V/F separation (V)	Setting range: 200~600	Mfr's value: 430
F680 Switch point width at V/F separation (%)	Setting range: 0.0~100.0	Mfr's value: 0.5

When F678=0, judgment voltage is invalid.

When F678=1, input voltage is judged automatically. When input voltage is higher than $(F679 + F679 * F680)$, the current input voltage is judged to T3 380V. If input voltage is lower than $(F679 + F679 * F680)$, the current input voltage is judged to S2 220V.

6.8. Malfunction and Protection

F700	Selection of terminal free stop mode	Setting range: 0: free stop immediately; 1: delayed free stop	Mfr's value: 0
F701	Delay time for free stop and programmable terminal action	Setting range: 0.0~60.0S	Mfr's value: 0.0

· “Selection of free stop mode” can be used only for the mode of “free stop” controlled by the terminal. The related parameters setting is F201=1, 2, 4.

When “free stop immediately” is selected, delay time (F701) will be invalid and inverter will free stop immediately.

· “Delayed free stop” means that upon receiving “free stop” signal, the inverter will execute “free stop” command after waiting some time instead of stopping immediately. Delay time is set by F701. During the process of speed track, the function of delayed free stop is invalid.

F702	Fan control mode	0: controlled by temperature 1: Running when inverter is powered on. 2: controlled by running status 3: Fan runs periodically	Mfr's value: 2
------	------------------	--	----------------

· When F702=0, fan will run if radiator's temperature is up to setting temperature.

· When F702=2, fan will run when inverter begins running. When inverter stops, fan will run according to the temperature of radiator.

· To control fan's running can increase the life of fan.

· When F702=3, fan is controlled by temperature. When the temperature is lower, fan will run 1 minute every 24 hours.

F704	Inverter Overloading pre-alarm Coefficient (%)	Setting range: 50~100	Mfr's value: 80
F705	Motor Overloading pre-alarm Coefficient (%)	Setting range: 50~100	Mfr's value: 80
F706	Inverter Overloading Coefficient (%)	Setting range: 120~190	Mfr's value: 150
F707	Motor Overloading Coefficient (%)	Setting range: 20~100	Mfr's value: 100

When inverter or motor is in over current status, if the accumulation time is more than inverter's or motor's overload protection time * F704 or F705, and F300 or F301 or F302=10 or 11, inverter will output ON signal.

Inverter overloading coefficient: the ratio of overload-protection current and rated current, whose value shall be subject to actual load.

· Motor overloading coefficient (F707): when inverter drives lower power motor, please set the value of F707 by below formula in order to protect motor

$$\text{Motor Overloading Coefficient} = \frac{\text{Actual motor power}}{\text{Matching motor power}} \times 100\%$$

Please set F707 according to actual situation. The lower the setting value of F707 is, the faster the overload protection speed. Please refer to Fig 6-20.

For example: 7.5kW inverter drives 5.5kW motor, $F707 = \frac{5.5}{7.5} \times 100\% \approx 70\%$. When the actual current of motor reaches 140% of inverter rated current, inverter overload protection will display after 1 minute.

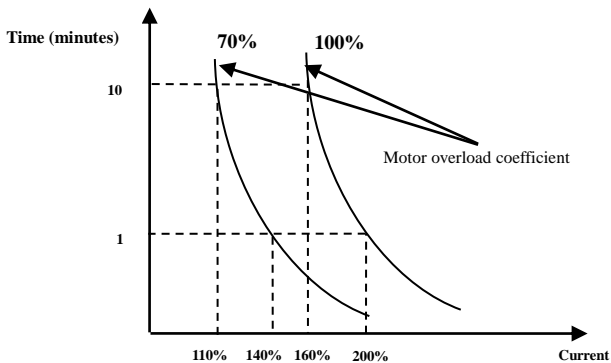

Fig 6-20 Motor overload coefficient

When the output frequency is lower than 10Hz, the heat dissipation effect of common motor will be worse. So when running frequency is lower than 10Hz, the threshold of motor overload value will be reduced. Please refer to Fig 6-21 (F707=100%):

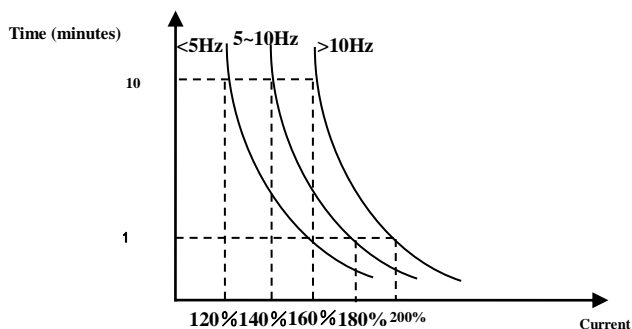

Fig 6-21 Motor overload protection value

F708	Record of The Latest Malfunction Type	Setting range: Please refer to Appendix 1.	
F709	Record of Malfunction Type for Last but One		
F710	Record of Malfunction Type for Last but Two		
F711	Fault Frequency of The Latest Malfunction (Hz)		
F712	Fault Current of The Latest Malfunction (A)		
F713	Fault PN Voltage of The Latest Malfunction (V)		
F714	Fault Frequency of Last Malfunction but One(Hz)		

F715	Fault Current of Last Malfunction but One(A)		
F716	Fault PN Voltage of Last Malfunction but One (V)		
F717	Fault Frequency of Last Malfunction but Two(Hz)		
F718	Fault Current of Last Malfunction but Two (A)		
F719	Fault PN Voltage of Last Malfunction but Two (V)		
F720	Record of overcurrent protection fault times		
F721	Record of overvoltage protection fault times		
F722	Record of overheat protection fault times		
F723	Record of overload protection fault times		
F724	Input phase loss	Setting range: 0: invalid; 1: valid	Mfr's value: S2: 0 T2/T3: 1
F725	Under-voltage protection	Setting range: 0: reset manually 1: reset automatically	Mfr's value: 2
F726	Overheat	Setting range: 0: invalid; 1: valid	Mfr's value: 1
F727	Output phase loss	Setting range: 0: invalid; 1: valid	Mfr's value: 1
F728	Input phase loss filtering constant (S)	Setting range: 1~60	Mfr's value: 5
F729	Under-voltage filtering constant (2mS)	Setting range: 1~3000	Mfr's value: 5
F730	Overheat protection filtering constant (S)	Setting range: 0.1~60.0	Mfr's value: 5.0
F732	Under-voltage protection voltage threshold (V)	Setting range: T2/S2: 120~450 T3: 300~450	Subject to inverter model

“Input phase loss” refers to phase loss of three-phase power supply, 7.5kW and below 7.5kW do not have this function.

“Output phase loss” refers to phase loss of inverter three-phase wirings or motor wirings.

“Under-voltage” / “phase loss” signal filtering constant is used for the purpose of eliminating disturbance to avoid mis-protection. The greater the set value is, the longer the filtering time constant is and the better for the filtering effect.

F737	Over-current 1 protection	Setting range: 0:Invalid 1: Valid	Mfr's value: 1
F738	Over-current 1 protection coefficient	Setting range: 0.50~3.00	Mfr's value: 2.5
F739	Over-current 1 protection record		

·F738= OC 1 value/inverter rated current

·In running status, F738 is not allowed to modify. When over-current occurs, OC1 is displayed

F741	Analog disconnected protection	Setting range: 0: Invalid 1: Stop and AErr displays. 2: Stop and Aerr is not displayed. 3: Inverter runs at the min frequency. 4: Reserved.	Mfr's value: 0
F742	Threshold of analog disconnected protection (%)	Setting range: 1~100	Mfr's value: 50

When the values of F400 and F406 are lower than 0.10V, analog disconnected protection is invalid. Analog channel AI3 has no disconnected protection.

When F741 is set to 1, 2 or 3, the values of F400 and F406 should be set to 1V-2V, to avoid the error protection by interference.

Analog disconnected protection voltage=analog channel input lower limit * F742. Take the AI1 channel for the example, if F400=1.00, F742=50, then disconnection protection will occur when the AI1 channel voltage is lower than 0.5V.

F745 Threshold of pre-alarm overheat (%)	Setting range: 0~100	Mfr's value: 80
F746 Carrier frequency auto-adjusting threshold	Setting range: 60~100	Mfr's value: 75
F747 Carrier frequency auto-adjusting	Setting range: 0: Invalid 1: Valid	Mfr's value: 1

When the temperature of radiator reaches the value of 90°C * F745 and multi-function output terminal is set to 16 (Please refer to F300~F302), it indicates inverter is in the status of overheat.

When temperature is higher than setting temperature, F746 is used to reduce carrier frequency.

When F747=1, the temperature of radiator reaches to certain temperature, inverter carrier frequency will adjust automatically, to decrease the temperature of inverter. This function can avoid overheat malfunction.

When F159=1, random carrier frequency is selected, F747 is invalid.

F750 Grounding delay (S)	0.0~3600.0	2.0
--------------------------	------------	-----

When grounding protection is valid, the time interval between stop and start is lower than the setting value of F750, the grounding detection is not performed.

F752 Overload quitting coefficient	Setting range: 0.1~20.0	Mfr's value: 1.0
F753 Selection of overload protection	Setting range: 0: Normal motor 1: variable frequency motor	Mfr's value: 1

The bigger the setting value of F752 is, the faster the shortened overload cumulative time is.

When F753=0, because heat dissipation effect of normal motor is bad in low speed, the electronic thermal protection value will be adjusted properly. It means overload protection threshold of motor will be decreased when running frequency is lower than 30Hz.

When F753=1, because heat dissipation effect of variable frequency motor is not influenced by speed, there is no need to adjust the protection value.

F754 Zero-current threshold (%)	Setting range: 0~200	Mfr's value: 5
F755 Duration time of zero-current (S)	Setting range: 0~60.0	Mfr's value: 0.5

When the output current is fallen to zero-current threshold, and after the duration time of zero-current, ON signal is output.

F756 Delay time when drive runs (ms)	Setting range: 0: Invalid 1~5000	Mfr's value: 0
F757 Delay time when drive stops (S)	Setting range: 0.0~100.0	Mfr's value: 5.0

When F756=0, bus voltage base is not detected when voltage limiting.

When F756 ≠ 0, after SD close, bus voltage will be detected recurrently after setting delay time.

After the drive stops, bus voltage will be detected recurrently after setting delay time. The detected value is saved in H016.

F759 Carrier-frequency ratio	Setting range: 3~15	Mfr's value: 15
------------------------------	---------------------	-----------------

carrier frequency=motor rated frequency *F759. When the product of rated frequency and F759 is higher than carrier frequency, actual carrier frequency will be increased automatically, and it will not be limited by temperature control carrier frequency.

F760 Grounding protection	Setting range: 0: Invalid 1: Valid after power on 2: Valid after running 3: Valid after power on and running	subject to inverter model
---------------------------	--	----------------------------------

When output terminals (U, V, W) are connected to the earth or the earth impedance is too low, then the leak current is high, inverter will trip into GP.

F760=0, grounding protection is invalid.

F760=1, grounding detection is performed after power on.

F760=2, grounding detection is performed after running.

F760=3, grounding detection is performed after power on and running.

Note: this function is invalid for T2 series.

F761 Switchover mode of FWD/REV	Setting range: 0: At zero 1: at start frequency	Mfr's value: 0
---------------------------------	--	----------------

When F761 = 0, FWD/REV switches at zero frequency, F120 is valid.

When F761 = 1, FWD/REV switches at start frequency, F120 is invalid, if start frequency is too high, current shock will occur during switchover process.

F770 Auxiliary version No.		
----------------------------	--	--

It only can be checked.

F772 Motor temperature detection channel selection	Setting range: 0: Invalid 1: AI1(PT100) 2: AI2(PT100) 3: AI1(PT1000) 4: AI2(PT1000)	Mfr's value: 0
F773 Motor overheat alarm threshold (°C)	Setting range: F774~200	Mfr's value: 110
F774 Motor overheat pre-alarm threshold (°C)	Setting range: 0~F773	Mfr's value: 90

F772 is used to select motor temperature detection channel. AI1 or AI2 must select 0~5V voltage input.

F773 is motor overheat alarm threshold. When motor temperature is higher than it, inverter will trip into OH4.

F774 is motor overheat pre-alarm threshold, when motor temperature is higher than it, DO token output is valid.

6.9. Parameters of the Motor

F800	Motor's parameters tuning	Setting range: 0: Invalid; 1: Rotating tuning; 2: stationary tuning	Mfr's value: 0
F801	Rated power (kW)	Setting range: 0.1~1000.0	
F802	Rated voltage (V)	Setting range: 1~1300	
F803	Rated current (A)	Setting range: 0.2~6553.5	
F804	Number of motor poles	Setting range: 2~100	4
F805	Rated rotary speed (rpm/min)	Setting range: 1~39000	
F810	Motor rated frequency (Hz)	Setting range: 1.00~590.00	50.00

Please set the parameters in accordance with those indicated on the nameplate of the motor.

Excellent control performance of vector control requires accurate parameters of the motor. Accurate parameter tuning requires correct setting of rated parameters of the motor.

In order to get the excellent control performance, please configure the motor in accordance with adaptable motor of the inverter. In case of too large difference between the actual power of the motor and that of adaptable motor for inverter, the inverter's control performance will decrease remarkably.

F800=0, parameter tuning is invalid. But it is still necessary to set the parameters F801~F803, F805 and F810 correctly according to those indicated on the nameplate of the motor.

After being powered on, it will use default parameters of the motor (see the values of F806-F809) according to the motor power set in F801. This value is only a reference value in view of Y series 4-pole asynchronous motor. For PMSM, please input motor parameters to F870~F873 manually.

F800=1, rotating tuning.

In order to ensure dynamic control performance of the inverter, select "rotating tuning" after ensuring that the motor is disconnected from the load. Please set F801-805 and F810 correctly prior to running testing. If control mode is closed-loop vector control, please set F851 correctly.

Operation process of rotating tuning: Press the "Run" key on the LED keypad to display "TEST", press "Run" key on the LCD keypad to display "parameter measurement..." and it will tune the motor's parameter of two stages. After that, the motor will accelerate according to acceleration time set at F114 and maintain it for a certain period. The motor will then decelerate to 0 according to the time set at F115. After auto-checking is completed, relevant parameters of the IM motor will be stored in function codes F806~F809. And relevant parameters of PMSM will be stored in F870~F873. F800 will turn to 0 automatically

F800=2, stationary tuning.

It is suitable for the cases where it is impossible to disconnect the motor from the load.

Press the "Run" key, and the inverter will display "TEST", and it will tune the motor's parameter of two stages. The motor's stator resistance, rotor resistance and leakage inductance will be stored in F806-F809 automatically (the motor's mutual inductance uses default value generated according to the power). For PMSM, electric parameters are stored to F870~F873. F870 is theory value, user can ask the accurate back electromotive force from manufacture. And F800 will turn to 0 automatically. The user may also calculate and input the motor's mutual inductance value manually according to actual conditions of the motor. With regard to calculation formula and method, please call us for consultation.

When tuning the motor's parameter, motor is not running but it is powered on. Please do not touch motor during this process.

***Note:**

1. No matter which tuning method of motor parameter is adopted, please set the information of the motor

(F801-F805) correctly according to the nameplate of the motor. If the operator is quite familiar with the motor, the operator may input all the parameters (F806-F809) of the motor manually.

2. Parameter F804 can only be checked, not be modified.
3. Incorrect parameters of the motor may result in unstable running of the motor or even failure of normal running. Correct tuning of the parameters is a fundamental guarantee of vector control performance. Each time when F801 rated power of the motor is changed, the parameters of the motor (F806-F809) will be refreshed to default settings automatically. Therefore, please be careful while amending this parameter. The motor's parameters may change when the motor heats up after running for a long time. If the load can be disconnected, we recommend auto-checking before each running.

F806 Stator resistance (Ω)	Setting range: 0.001~65.53 Ω (for 15kw and below 15kw) 0.1~6553m Ω (For above 15kw)	Subject to inverter model
F807 Rotor resistance (Ω)	Setting range: 0.001~65.53 Ω (for 152kw and below 15kw) 0.1~6553m Ω (For above 15kw)	
F808 Leakage inductance (mH)	Setting range: 0.01~655.3mH (for 15kw and below 15kw) 0.001~65.53mH (for above 15kw)	
F809 Mutual inductance (mH)	Setting range: 0.1~6553mH (for 15kw and below 15kw) 0.01~655.3mH (for above 15 kw)	
F844 Motor no-load current (A)	Setting range: 0.1~F803	

The set values of F806~F809 will be updated automatically after normal completion of parameter tuning of the motor.

If it is impossible to measure the motor at the site, input the parameters manually by referring to the known parameters of a similar motor.

F844 can be got automatically by rotating tuning.

If the no-load current is higher when motor is running, please decrease the value of F844.

If running current or start current is higher when motor is running with load, please increase the value of F844.

Take a 3.7kW inverter for the example: all data are 3.7kW, 400V, 8.8A, 1440rpm, 50Hz, and the load is disconnected. When F800=1, the operation steps are as following:

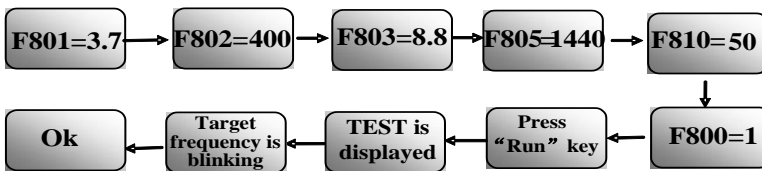

F811 Carrier frequency switchover point (Hz)	Setting range: 0.00~20.00	Mfr's value: 8.00
--	---------------------------	-------------------

When F811 = 0, there is no carrier frequency switchover.

When F811≠0, and frequency is lower than switchover point, carrier frequency is internal fixed carrier-frequency. When running frequency is higher than switchover point, carrier frequency will switch to setting carrier frequency.

F812	Pre-exciting time (S)	Setting range: 0.00~30.00	0.10
F813	Rotary speed loop KP1	Setting range: 1~100	30
F814	Rotary speed loop KI1	Setting range: 0.01~10.00	0.50
F815	Rotary speed loop KP2	Setting range: 1~100	Subject to inverter model
F816	Rotary speed loop KI2	Setting range: 0.01~10.00	1.00
F817	PID switching frequency 1	Setting range: 0~F818	5.00
F818	PID switching frequency 2	Setting range: F817~F111	10.00

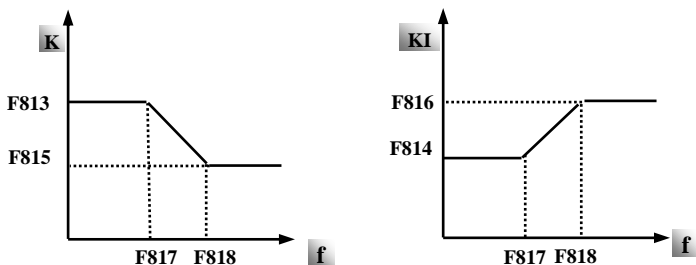

Fig 6-22 PID parameter

Dynamic response of vector control speed can be adjusted through adjusting proportional and storage gains of speed loop. Increasing KP and decreasing KI can speed up dynamic response of speed loop. However, if proportional gain or storage gain is too large, it may give rise to oscillation.

Recommended adjusting procedures:

Make fine adjustment of the value on the basis of manufacturer value if the manufacturer setting value cannot meet the needs of practical application. Be cautious that amplitude of adjustment each time should not be too large.

In the event of weak loading capacity or slow rising of rotary speed, please decrease the value of KP first under the precondition of ensuring no oscillation. If it is stable, please increase the value of KI properly to speed up response.

In the event of oscillation of current or rotary speed, decrease KP and increase KI properly.

Note: Improper setting of KP and KI may result in violent oscillation of the system, or even failure of normal operation. Please set them carefully.

F819 Slip coefficient	Setting range: 10~200	Mfr's value: 100
F820 Filtering coefficient of speed loop	Setting range: 0~100	Mfr's value: 0

F819 is used to adjust steady speed precision of motor in vector control.

In vector control mode, if speed fluctuation is higher or inverter stops instability, please increase the value of F820 properly; it will influence response speed of speed loop.

F821 Over-excitation gain	Setting range: 0.0~50.0	Mfr's value: 30.0
---------------------------	-------------------------	-------------------

This function could hold the pump voltage at DC bus.

The value is higher, the effect of the function is better. But the output current during deceleration is also higher. It is possible to cause over-current protection.

F822 Upper limit of speed control torque	Setting range:0.0~250.0	Mfr's value: 200
--	-------------------------	------------------

The parameter of F822 limits the output current in the vector control mode.

F838 SVC control mode	Setting range: 1: control mode 1 2: control mode 2	Mfr's value: 2
-----------------------	---	----------------

F838=1, SVC control mode 1. F838=2, SVC control mode 2.

F839 Weak magnetism coefficient	Setting range: 0.10~2.00	Mfr's value:1.00
---------------------------------	--------------------------	------------------

This function is used to modify motor weak magnetism curve. The smaller the value is, the shallower the weak magnetism depth is. The bigger the value is, the deeper the weak magnetism depth is.

F840 Stop after detecting feedback value	Setting range: 0: By feedback speed 1: By given speed	Mfr's value: 0
--	---	----------------

F840=0, in deceleration process, inverter will stop until feedback speed meets the needs of stop command. .

F840=1, in deceleration process, inverter will stop until given speed meets the needs of stop command.

F847 Encoder disconnection detection time(s)	Setting range: 0.1~10.0	Mfr's value: 2.0
--	-------------------------	------------------

This parameter is only valid in encoder vector control mode. Using F847 to define the encoder signal disconnection detection time under the closed-loop vector control mode when F106=1. PG protection is given if detection time exceeds the setting value.

F850 Detection threshold of encoder disconnection	Setting range: 5~100	Mfr's value: 30
---	----------------------	-----------------

In the closed-loop vector control mode, when the difference between encoder setting frequency and actual frequency is higher than F850, and duration time is longer than F847, inverter will trip into PG.

F851 Encoder resolution	Setting range: 1~9999	Mfr's value: 1000
-------------------------	-----------------------	-------------------

Note: when F106=1, PG card must be installed, and set encoder resolution correctly

F854 Encoder phase sequence	Setting range: 0: forward direction 1: reverse direction	Mfr's value: 0
-----------------------------	---	----------------

F854 is used to set phase sequence of differential and non-differential ABZ incremental encoder. In closed-loop vector mode, correct encoder phase sequence can be got by rotating tuning.

If motor parameters cannot be studied by rotating tuning, please set F854 by checking H015 value.

For example, inverter runs more than 5s in V/F control mode, after inverter stops, then check the value of H015. If H015=0, please do not change the value of F854. If H015=1, then change the value of F854.

F866 Static position identification	Setting range: 0: Invalid 1: Valid 2: valid at first running	Mfr's value: 2
F867 Position identification current	Setting range: 0~30	Mfr's value: 10
F868 Position identification frequency	Setting range: 2000~16000	Mfr's value: 10000

F868: during position identification process, F868 is the frequency of output high-frequency voltage.

Note: F866~F868 is only for synchronous motor.

F870 PMSM back electromotive force (mV/rpm)	Setting range: 0.1~6553.0 (valid value between lines)	Mfr's value: 100.0
F871 PMSM D-axis inductance (mH)	Setting range: 0.01~655.30	Mfr's value:5.00

F872	PMSM Q-axis inductance (mH)	Setting range: 0.01~655.30	Mfr's value:7.00
F873	PMSM stator resistance (Ω) (phase resistor)	Setting range: 0.001~65.530	Mfr's value:0.500

* F870(back electromotive force of PMSM, unit = 0.1mV/1rpm, it is back electromotive force value between lines), it is forbidden to revert to Mfr's value by F160.

* F871(PMSM D-axis inductance, unit = 0.01 mH), it is forbidden to revert to Mfr's value by F160.

* F872(PMSM Q-axis inductance, unit = 0.01 mH), it is forbidden to revert to Mfr's value by F160.

* F873(PMSM Stator resistance, unit = m-ohm, 0.001 ohm), it is forbidden to revert to Mfr's value by F160.

* F870-F873 are motor parameters of PMSM, they are not shown in the motor nameplate. User can get them by auto tuning or asking manufacture.

F874 Position identification times	Setting range: 5~50	Mfr's value: 30
F875 Position identification angle compensation	Setting range: 0~1000	Mfr's value: 0

F875 is used to get correct rotor position.

F876 PMSM injection current without load (%)	Setting range: 0.0~100.0	Mfr's value: 10.0
F877 PMSM injection current compensation without load (%)	Setting range: 0.0~50.0	Mfr's value: 20.0
F878 PMSM cut-off point of injection current compensation without load (%)	Setting range: 0.0~50.0	Mfr's value: 10.0
F879 PMSM injection current with heavy load (%)	Setting range: 0.0~100.0	Mfr's value: 0.0

F876, F877 and F879 are the percent of rated current. F878 is the percent of rated frequency.

For example:

When F876=20, if F877=10 and F878=0, the injection current without load is 20% of rated current.

When F876=20, if F877=10 and F878=10, and rated frequency is 50Hz, injection current without load will decrease by a linear trend from 30 (F876+F877). When inverter runs to 5Hz (5Hz=rated frequency X F878%), injection current will decrease to 20, and 5Hz is cut-off point of injection current compensation without load.

F880	PMSM PCE detection time (S)	Setting range: 0.0~10.0	Mfr's value: 0.2
------	-----------------------------	-------------------------	------------------

6.10. Communication Parameter

F900 Communication Address	Setting range: 1~255: single inverter address 0: broadcast address	Mfr's value: 1
F901 Communication Mode	Setting range: 1: ASCII 2: RTU 3: Remote keypad	Mfr's value: 2
F902 Stop bits	Setting range: 1~2	Mfr's value: 2
F903 Parity Check	Setting range: 0: Invalid 1: Odd 2: Even	Mfr's value: 0
F904 Baud Rate	Setting range: 0: 1200; 1: 2400; 2: 4800; 3: 9600; 4: 19200 5: 38400 6: 57600	Mfr's value: 3
F905 Communication timeout period (S)	Setting range: 0.0~3000.0	Mfr's value: 0.0
F907 Time 2 of communication timeout (S)	Setting range: 0.0~3000.0	Mfr's value: 0.0

F904=9600 is recommended for baud rate, which makes run steady. Communication parameters refer to Appendix 4.

When F905 is set to 0.0, the function is invalid. When $F905 \neq 0.0$, if the inverter has not received effective command from PC/PLC during the time set by F905, inverter will trip into CE.

When $F907 > 0$, and receiving the previous data, if after the time set by F907, the next data is not received, inverter will output communication timeout signal. The timeout signal will be cleared by this terminal, and after receiving correct data, inverter will accumulate time again.

F911 Point-point communication selection	Setting range: 0:Disabled 1:Enabled	Mfr's value:0
F912 Master and slave selection	Setting range: 0:Master 1:Slave	Mfr's value: 0

F911 is used to decide whether to enable point-point communication.

F912 is used to decide whether inverter is master or slave.

F913 Running command of slave	Setting range: 0:Slave not following running commands of master 1:Slave following running commands of master	Mfr's value: 1
-------------------------------	--	----------------

When F913=1, the slave follows the master to start or stop. Except emergency stop command, please do not send stop command to slave. If slave stops by keypad, slave will trip into ESP.

F914 Fault information of slave	Setting range: Ones: slave fault information 0: Not sending fault information 1: Sending fault information Tens: master's reaction when it loses slave's response 0: No reaction 1: Alarm	Mfr's value: 01
F915 Master action when slave failed	Setting range: 0: continue running 1: free stop 2: Deceleration to stop	Mfr's value: 1

F914 ones: it is used to decide whether to send slave fault information to master.

Tens: when master loses slave's response (must be on-line status), master will trip into Er44.

When F915=1 or 2, after inverter stops, remove the running command between master and slave, after

troubleshooting of slave, master can restart again.

F916 Slave action when master stops	Setting range: 1: Free stop 2: Deceleration to stop	Mfr's value: 1
-------------------------------------	--	----------------

When F913=1, F916 is valid.

When F916 = 1, slave will free stop.

When F916 = 2, slave will stop according to deceleration time.

F917 Slave following master command selection	Setting range: 0: given torque(torque) 1: given frequency 1(Droop) 2: given frequency 2 (Droop)	Mfr's value: 0
---	--	----------------

The information type selection of master and slave must be same.

When F917 = 0, it is suitable for rigid connection occasion. Master must run in vector control mode, slave must run at torque control, and the limit speed of slave must be set correctly.

When F917 = 1 and 2, it is suitable for flexible connection occasion. Master and slave will work at speed mode and droop control function is valid. When F917=1, the target frequency is master given frequency.

When F917=2, master given frequency is present frequency (only valid in VVVF control).

F918 Zero offset of received data (torque)	Setting range:0.00~200.00	Mfr's value: 100.00
F919 Gain of received data(torque)	Setting range:0.00~10.00	Mfr's value: 1.000

F918 and F919 are used to adjust torque received from the master. The adjustment formula is as below:

$$y = F919 * x + F918 - 100.00.$$

When F918=100.00, it means no zero bias.

F920 Zero offset of received data (frequency)	Setting range:0.00~200.00	Mfr's value:100.00
F921 Gain of received data(frequency)	Setting range:0.00~10.00	Mfr's value:1.00

F920 and F921 are used to adjust frequency received from the master. The adjustment formula is as below: $y = F921 * x + F920 - 100.00$

When F920=100.00, it means no zero bias.

F922 window	Setting range: 0.00~10.00	Mfr's value: 0.50
-------------	---------------------------	-------------------

When F917=0, F922 is valid. It is used to limit the slave speed in torque control mode.

F923 Droop control	Setting range: 0.0(Invalid) 0.1~30.0	Mfr's value: 0.0
--------------------	---------------------------------------	------------------

When F917 =1 and 2, droop control is valid when master and slave are both in speed control mode.

Droop control allows tiny speed deviation between master and slave, reasonable droop rate setting needs to be adjusted according to actual situation.

Droop speed= synchronizing frequency *output torque * droop rate

inverter actual output frequency = synchronizing frequency – droop speed

For example, when F923 = 7%, synchronizing frequency is 45Hz, output torque is 35%,

$$\text{Then inverter actual output frequency} = 45 - (45 * 0.35 * 0.07) = 43.90\text{Hz}.$$

F924 Time of communication timeout (S)	Setting range: 0.0~3000.0	Mfr's value: 0.0
--	---------------------------	------------------

when F924=0.0, inverter does not test the timeout.

F925 Master sending data interval (S)	Setting range: 0.000~1.000	Mfr's value: 0.0
F926 CAN baud rate (kbps)	Setting range: 0: 20 1:50 2:100 3:125 4:250 5:500 6:1000	Mfr's value: 6

Please refer to Appendix 8 for master/slave control operation.

F928 BACnet address	Setting range: 0~127	Mfr's value: 1
F929 BACnet baud rate (bps)	Setting range: 0:9600 1: 19200 2: 38400 3:76800	Mfr's value: 1

F934 Master/slave adjustment time benchmark (S)	Setting range: 0.0~10.0	Mfr's value: 0.5
F935 Master/slave adjustment current error (%)	Setting range: 0.0~50.0	Mfr's value: 5.0
F936 Adjustment mode of accel/decel	Setting range: 0: mode 0 1: mode 1	Mfr's value: 0

This function is only valid during the accel/decel process of master/slave control mode.

F934 is the max adjustment accel/decel time when slave is running in the accel/decel process.

If the percentage of output current and rated current is higher than F935, slave will adjust accel/decel time.

F936 is adjustment mode of accel/decel.

F936=0 is mode 0, it is adjusted according to master/slave output torque.

F936=1 is mode 1, it is adjusted according to master/slave output current.

F937 Slave adjustment frequency mode	Setting range: 0: no adjustment 1: Current balance adjustment 2: current PID adjustment	Mfr's value: 1
F938 Slave adjustment max frequency (Hz)	Setting range: 0.00~5.00	Mfr's value: 0.10
F939 Slave adjustment frequency period (S)	Setting range: 0.00~10.00	Mfr's value: 0.50

F937 is slave adjustment frequency mode.

F937=0, this function is invalid.

F937=1, slave current is adjusted according to current balance of master/slave.

When current balance of slave and master is higher than F935, slave will decrease frequency automatically, adjustment period is adjusted by F939.

When current balance of slave and master is lower than F935, slave frequency remains constant.

When current balance of master and slave is higher than F935, slave will increase frequency, to make sure the current balance within the range of F935.

F937 =2, slave output frequency is adjusted by PID to make sure the current balance within the range of F935.

F938 is slave adjustment max frequency.

F939 is slave adjustment frequency period. The bigger the value is, the slower the frequency changes.

Note:

- 1) When F937=1 or 2, F936 is used to select current adjustment or torque adjustment.
- 2) When F936=1, slave and master should not have electricity generation, inverter can trip into over voltage easily.
- 3) Max frequency(F111) must be higher than target frequency 1.00Hz

6.11 PID Parameters

6.11.1 Internal PID adjusting and constant pressure water supply

Internal PID adjusting control is used for single pump or double pump automatic constant-pressure water supply, or used for simple close-loop system with convenient operation.

The usage of pressure meter:

As FA02=1: channel AI1

“10V” connect with the power supply of pressure meter, if the power supply of pressure meter is 5V, please supply a 5V power.

“AI1” connect with the pressure signal port of pressure meter

“GND” connect with the grounding of pressure meter

As FA02=2: channel AI2

“10V” connect with the power supply of pressure meter, if the power supply of pressure meter is 5V, please supply a 5V power.

“AI2” connect with the pressure signal port of pressure meter

“GND” connect with the grounding of pressure meter

For current type sensor, two-line 4-20mA signal is inputted to inverter, please connect CM to GND, and 24V is connected to power supply of sensor.

6.11.2 Parameters

FA00 Water supply mode	Setting range: 0: Single pump (PID control mode) 1: Fixed mode 2: Timing interchanging	Mfr's value: 0
------------------------	---	----------------

When FA00=0 and single pump mode is selected, the inverter only controls one pump. The control mode can be used in the closed-loop control system, for example, pressure, flow.

When FA00=1, one motor is connected with converter pump or general pump all the time.

When FA00=2, two pumps are interchanging to connect with inverter for a fixed period of time, this function should be selected. The duration time is set by FA25.

FA01 PID adjusting target given source	Setting range: 0: FA04 1: AI1 2: AI2 3: AI3 (Potentiometer on the keypad) 4: FI (pulse frequency input)	Mfr's value: 0
--	--	----------------

When FA01=0, PID adjusting target is given by FA04 or MODBUS.

When FA01=1, PID adjusting target is given by external analog AI1.

When FA01=2, PID adjusting target is given by external analog AI2.

When FA01=3, PID adjusting target is given by the AI3 potentiometer on the keypad.

When FA01=4, PID adjusting target is given by FI pulse frequency (DI1 terminal).

FA02 PID adjusting feedback given source	Setting range: 1: AI1 2: AI2 3: FI (pulse frequency input) 4: reserved 5: Running current 6: Output power 7: Output torque	Mfr's value: 1
--	--	----------------

When FA02=1, PID feedback signal is given by external analog AI1.

When FA02=2, PID feedback signal is given by external analog AI2.

When FA02=3, PID feedback signal is given by FI pulse frequency input.

When FA02=5, PID feedback signal is given by inverter running current.

When FA02=6, PID feedback signal is given by output power.

When FA02=7, PID feedback signal is given by output torque.

FA03 Max limit of PID adjusting (%)	FA04~100.0	Mfr's value: 100.0
FA04 Digital setting value of PID adjusting (%)	FA05~FA03	Mfr's value: 50.0
FA05 Min limit of PID adjusting (%)	0.0~FA04	Mfr's value: 0.0

When negative feedback adjusting is valid, if pressure is higher than max limit of PID adjusting, pressure protection will occur. If inverter is running, it will free stop, and "nP" is displayed. When positive feedback adjusting is valid, if pressure is higher than Max limit, it indicates that feedback pressure is too low, inverter should accelerate or a linefrequency should be added to increase the displacement.

When FA01=0, the value set by FA04 is digital setting reference value of PID adjusting.

When positive feedback adjusting is valid, if pressure is higher than min limit of PID adjusting, pressure protection will occur. If inverter is running, it will free stop, and "nP" is displayed. When negative feedback adjusting, if pressure is higher than min limit, it indicates that feedback pressure is too low, inverter should accelerate or a linefrequency should be added to increase the displacement.

For example: if the range of pressure meter is 0-1.6MPa, then setting pressure is $1.6*70\%=1.12\text{MPa}$, and the max limit pressure is $1.6*90\%=1.44\text{MPa}$, and the min limit pressure is $1.6*5\%=0.08\text{MPa}$.

FA06 PID polarity	0: Positive feedback 1: Negative feedback	Mfr's value: 1
-------------------	--	----------------

When FA06=0, the higher feedback value is, the higher the motor speed is. This is positive feedback.

When FA06=1, the lower the feedback value is, the higher the motor speed is. This is negative feedback.

FA07 Dormancy function selection	Setting range: 0: Valid 1: Invalid	Mfr's value: 1
----------------------------------	------------------------------------	----------------

When FA07=0, if inverter runs at the min frequency FA09 for a period time set by FA10, inverter will stop.

When FA07=1, the dormancy function is invalid.

FA09 Min frequency of PID adjusting (Hz)	Setting range: Max(F112, 0.1)~F111	Mfr's value: 5.00
--	---------------------------------------	-------------------

The min frequency is set by FA09 when PID adjusting is valid.

FA10 Dormancy delay time (S)	Setting range: 0.0~500.0	Mfr's value: 15.0
------------------------------	--------------------------	-------------------

When FA07=0, inverter runs at min frequency FA09 for a period time set by FA10, inverter will free stop and enter into the dormancy status, "np" is displayed.

FA11 Wake delay time (S)	Setting range: 0.0~3000	Mfr's value: 3.0
--------------------------	-------------------------	------------------

After the wake delay time, if the pressure is lower than min limit pressure (Negative feedback), inverter will begin running immediately, or else, inverter will be in the dormancy status.

FA67 Dormancy mode	Setting range: 0: dormancy mode 1 1: dormancy mode 2	Mfr's value: 0
FA68 Given pressure offset 1 (%)	Setting range: 0.0~100.0	Mfr's value: 30.0
FA69 Given pressure offset 2 (%)	Setting range: 0.0~100.0	Mfr's value: 30.0

When FA67=0, inverter will be awoken according to FA03 and FA05.

If FA67=1 and FA06=1, when pressure is higher than target pressure, and PID adjusts to min frequency, inverter will enter into dormancy status after the setting time of FA10. If inverter is in the dormancy status and pressure is lower than target pressure-FA69, inverter will be awoken after wake delay time.

If FA06=0, when pressure is lower than target pressure, and PID adjusts to min frequency, inverter will free stop and enter into dormancy status after the setting time of FA10. If inverter is in the dormancy status, when pressure is higher than target pressure + FA68, inverter will be awoken after weak delay time.

FA12 PID max frequency (Hz)	Setting range: FA09~F111	Mfr's value: 50.00
-----------------------------	--------------------------	--------------------

When PID is valid, FA12 is used to set the max frequency.

FA18 Whether PID adjusting target is changed	0: Invalid 1: Valid	Mfr's value: 1
--	---------------------	----------------

When FA18=0 and FA01≠0, PID adjusting target cannot be changed.

FA19 Proportion Gain P	Setting range: 0.00~10.00	Mfr's value: 0.30
FA20 Integration time I (S)	Setting range: 0.1~100.0	Mfr's value: 0.3
FA21 Differential time D (S)	Setting range: 0.0~10.0	Mfr's value: 0.0
FA22 PID sampling period (S)	Setting range: 1~500	Mfr's value: 5

Increasing proportion gain, decreasing integration time and increasing differential time can increase the dynamic response of PID closed-loop system. But if P is too high, I is too low or D is too high, system will not be steady.

PID adjusting period is set by FA22. It affects PID adjusting speed.

The following is PID adjusting arithmetic.

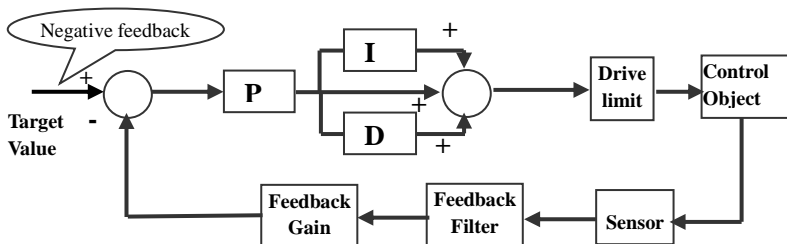

FA23 PID negative frequency output selection	Setting range: 0: Invalid 1: Valid 2: only output negative frequency	Mfr's value: 0
--	--	----------------

When FA23=0, PID output frequency is FA09~FA12.

When FA23=1, PID output frequency is -FA12~FA12. The negative sign stands for reverse direction.

When FA23=2, PID output frequency is -FA12~0. The negative sign stands for reverse direction.

FA24 Switching Timing unit setting	Setting range: 0: hour 1: minute	Mfr's value: 0
FA25 Switching Timing Setting	1~9999	Mfr's value: 100

Switching time is set by F525. The unit is set by F524.

FA26 Under-load protection mode	Setting Range 0: No protection 1: Protection by contactor 2: Protection by PID 3: Protection by current	Mfr's value: 0
FA27 Current threshold of under-load protection (%)	Setting range: 10~150	Mfr's value: 50
FA66 Duration time of under-load protection (S)	Setting range: 0~60.0	Mfr's value: 1.0

Note: the percent of under-load protection current corresponds to motor rated current.

Under-load protection is used to save energy. For some pumps device, when the output power is too low, the efficiency will get worse, so we suggest that the pumps should be closed.

During the running process, if the load decreases to zero suddenly, it means the mechanical part is broken. For example, belt is broken or water pump is dried up. Under-load protection must occur.

When FA26=1, water signal and lack water signal is controlled by two input terminals. When the lack water terminal is valid, inverter will enter into the protection status, and EP1 is displayed. When the water terminal is valid, inverter will deactivate EP1 fault automatically.

When FA26=2, PID adjusting frequency runs to max frequency, if inverter current is lower than the product FA27 and rated current, inverter will enter PID under-load protection status immediately, and EP2 is displayed.

When FA26=3, if inverter current is lower than the product of FA27 and rated current, after duration time of FA66, inverter will enter under-load protection, and EP3 is displayed.

FA28 Waking time after protection (min)	1~3000	Mfr's value: 60
---	--------	-----------------

After the duration time of FA28, inverter will judge that whether the under-load protection signal disappears. If malfunction is resetted, inverter will run again. Or else inverter will wait until malfunction is resetted. User can reset the inverter by pressing "stop/reset", inverter will stop.

FA29 PID dead time (%)	0.0~10.0	Mfr's value: 2.0
FA30 Running Interval of restarting converter pump (S)	2.0~999.9	Mfr's value: 20.0
FA31 Delay time of starting general pumps (S)	0.1~999.9	Mfr's value: 30.0
FA32 Delay time of stopping general pumps (S)	0.1~999.9	Mfr's value: 30.0

FA29, PID dead time has two functions. First, setting dead time can restrain PID adjustor oscillation. The greater this value is, the lighter PID adjustor oscillation is. But if the value of FA29 is too high, PID adjusting precision will decrease. For example: when FA29=2.0% and FA04=70, PID adjusting will not invalid during the feedback value from 68 to 72.

Second, FA29 is set to PID dead time when starting and stopping general pumps by PID adjusting. When negative feedback adjusting is valid, if feedback value is lower than value FA04-FA29 (which equal to set value MINUS dead-time value), inverter will delay the set time of FA31, and then start the general pump. If feedback value is higher than value FA04+FA29 (which equal to set value PLUS dead-time value), inverter will delay the set time of FA32, then stop the general pump.

- When starting general pump or interchange time is over, inverter will free stop. After starting general pump, inverter will delay the set time of FA30, and restart converter pump.
- When inverter drives two pumps and negative feedback adjusting, if the frequency already reach the max value and after the delay time (FA31), the pressure value is still lower than the value, then the inverter will stop output immediately and motor will freely stop. At the same time, the general pump will be started. After the general pump is fully run, if the present pressure is higher than the set value, inverter will low down the output to the min frequency. After delaying the set time (FA32), inverter will stop the general pump and start converter pump.
- When inverter drives two pumps and positive feedback adjusting, if the frequency already reach the max value and after the delay time (FA31), the pressure value still higher than the value, then the inverter will stop output immediately and motor will freely stop. At the same time the general pump will be started. After the general pump runs, if the present pressure is lower than the set value, inverter will low down the output to the min frequency. After delaying the set time (FA32), inverter will stop the general pump and start converter pump.

FA33 stop mode when constant pressure water supply	0: free stop 1: deceleration to stop	Mfr's value: 0
--	---	----------------

FA33 is used to set the stop mode after inverter stops converter pump or trips into nP and EP.

FA36 Whether No.1 relay is available	0: unavailable 1: available	Mfr's value: 0
FA37 Whether No.2 relay is available	0: unavailable 1: available	Mfr's value: 0

No 1 relay corresponds to the terminal DOI in the control PCB, No 2 relay corresponds to the terminal TA/TC

FA38 Proportion gain Kp2	Setting range: 0.00~10.00	Mfr's value: 0.30
FA39 Integration time Ki2(S)	Setting range: 0.1~100.0	Mfr's value: 0.3
FA40 Differential time Kd2(S)	Setting range: 0.0~10.0	Mfr's value: 0.0
FA41 PI parameter switchover type	Setting range: 0: no switchover 1: reserved 2: Auto switchover 3: reserved	Mfr's value: 0
FA42 Switchover error 1	Setting range: FA05~FA43	Mfr's value: 0.0

FA43 Switchover error 2	Setting range: FA42~FA03	Mfr's value: 0.0
-------------------------	--------------------------	------------------

FA38~FA40 is the second group of PID parameters. They can be used with the first group parameters separately.

When FA41=0, the first group PID parameters are used. The parameters are FA19~FA21.

When FA41=2, if the current error(difference between PID given value and PID feedback) is higher than FA43, the second group of PID parameters will be used. When the current error is lower than FA42, the first group of PID parameters will be used. When current error is between error 1 and error 2, PID will use transition parameters.

FA47 The sequence of starting No 1 relay	Setting range: 1~20	Mfr's value: 20
FA48 The sequence of starting No 2 relay	Setting range: 1~20	Mfr's value: 20

The sequence of starting relays is set by FA47~FA48. The setting value of FA47 and FA48 must be different with each other, or else "Err5" is displayed in the keypad.

FA58 Fire pressure given value (%)	Setting range: 0.0~100.0	Mfr's value: 80.0
------------------------------------	--------------------------	-------------------

FA58 is also called second pressure, when the fire control terminal is valid, pressure target value will switch into second pressure value.

FA59 Emergency fire mode	Setting range: 0: Invalid 1: Emergency fire mode 1 2: Emergency fire mode 2	Mfr's value: 0
--------------------------	---	----------------

When emergency fire mode is valid and emergency fire terminal is valid, inverter will be forbidden operating and protecting (When OC and OE protection occur, inverter will reset automatically and start running). And inverter will run at the frequency of FA60 or target frequency until inverter is broken.

Emergency fire mode 1: when the terminal is valid, inverter will run at target frequency.

Emergency fire mode 2: when the terminal is valid, inverter will run at the frequency of FA60.

FA60 Running frequency of emergency fire	Setting range: F112~F111	Mfr's value: 50
--	--------------------------	-----------------

When the emergency fire mode 2 is valid and the fire terminal is valid, inverter will run at the frequency set by FA60.

FA62 when fire emergency control terminal is invalid	Setting range: 0~1	Mfr's value: 0
--	--------------------	----------------

When FA62=0, inverter keeps working at fire emergency mode

When FA62=1, inverter will quit from fire emergency mode.

FA76 Frequency range of under load(Hz)	Setting range: F112~F113	Mfr's value: 5.00
FA77 running mode of under load	Setting range: 0: invalid 1: free stop 2: stop by decelerating time 3: run at FA76	Mfr's value: 0

• FA77=0: The protection of under load is not enable.

• FA77=1: When the inverter runs normally, the output current is higher than under-load protection current. When the inverter is in the process of under load, the output current is lower than under-load protection current(motor's rated current *FA27), and keep longer time than FA66. Then, the inverter will free stop and displays Er55.

• FA77=2: When the inverter is in the process of under load, the output current is lower than under-load protection current(motor's rated current *FA27), and keep longer time than FA66. Then, the inverter will stop by decelerating time and displays Er55.

• FA77=3: When the inverter is in the process of under load, the output current is lower than under-load protection current(motor's rated current *FA27), and keep longer time than FA66. Then, the inverter will run at FA76. If the load is recovered, the inverter will automatically run at the target frequency.

6.13 Torque control parameters

FC00 Speed/torque control selection	0: Speed control 1: Torque control 2: Terminal switchover	0
-------------------------------------	---	---

0: speed control. Inverter will run by setting frequency, and output torque will automatically match with the torque of load, and output torque is limited by max torque (set by manufacture.)

1: Torque control. Inverter will run by setting torque, and output speed will automatically match with the speed of load, and output speed is limited by max speed (set by FC23 and FC25). Please set the proper torque and speed limited.

2: Terminal switchover. User can set DIX terminal as torque/speed switchover terminal to realize switchover between torque and speed. When the terminal is valid, torque control is valid. When the terminal is invalid, speed control is valid.

FC02	Torque accel/decel time (S)	0.1~100.0	1.0
------	-----------------------------	-----------	-----

The time is for inverter to run from 0% to 100% of rated torque.

FC06	Torque given channel	0: Digital given (FC09) 1: Analog input AI1 2: Analog input AI2 3: Analog input AI3 4: Pulse input channel FI 5: Reserved	0
------	----------------------	--	---

When FC06=4, only DI1 terminal can be selected because only DI1 terminal has the pulse input function.

FC07	Torque given coefficient	0~3.000	3.000
FC09	Torque given command value (%)	0~300.0	100.0

FC07: when input given torque reaches max value, FC07 is the ratio of inverter output torque and motor rated torque. For example, if FC06=1, F402=10.00, FC07=3.00, when AI1 channel output 10V, the output torque of inverter is 3 times of motor rated torque.

FC14	Offset torque given channel	0: Digital given (FC17) 1: Analog input AI1 2: Analog input AI2 3: Analog input AI3 4: Pulse input channel FI 5: Reserved	0
FC15	Offset torque coefficient	0~0.500	0.500
FC16	Offset torque cut-off frequency (%)	0~100.0	10.0
FC17	Offset torque command value (%)	0~50.0	10.00

· Offset torque is used to output larger start torque which equals to setting torque and offset torque when motor drives big inertia load. When actual speed is lower than the setting frequency by FC16, offset torque is given by FC14. When actual speed is higher than the setting frequency by FC16, offset torque is 0.

· When FC14≠0, and offset torque reaches max value, FC15 is the ratio of offset torque and motor rated torque. For example: if FC14=1, F402=10.00 and FC15=0.500, when AI1 channel outputs 10V, offset torque is 50% of motor rated torque.

FC22	Forward speed limited channel	0: Digital given (FC23) 1: Analog input AI1 2: Analog input AI2 3: Analog input AI3 4: Pulse input channel FI 5: Reserved	0
FC23	Forward speed limited (%)	0~100.0	10.0

FC24	Reverse speed limited channel	0: Digital given (FC25) 1: Analog input AI1 2: Analog input AI2 3: Analog input AI3 4: Impulse input FI 5: Reserved	0
FC25	Reverse speed limited (%)	0~100.0	10.0

Speed limited FC23/FC25: if given speed reaches max value, they are used to set percent of inverter output frequency and max frequency F111.

FC28	Electric torque limit channel	0: Digital given (FC30) 1: Analog input AI1 2: Analog input AI2 3: Analog input AI3 4: Pulse input channel FI 5: Reserved	0
FC29	Electric torque limit coefficient	0~3.000	3.000
FC30	Electric torque limit (%)	0~300.0	200.0
FC33	Braking torque limit channel	0: Digital given (FC35) 1: Analog input AI1 2: Analog input AI2 3: Analog input AI3 4: Pulse input channel FI 5: Reserved	0
FC34	Braking torque limit coefficient	0~3.000	3.000
FC35	Braking torque limit (%)	0~300.0	200.00

When motor is in the electric status, output torque limit channel is set by FC28. When FC28 does not equal to 0, limit torque is set by FC29. When FC28=0, limit torque is set by FC30.

When motor is in the Braking status, Braking torque limit channel is set by FC31. When FC33 does not equal to 0, limit torque is set by FC34. When FC33=0, limit torque is set by FC35.

FC36	Torque lower limit enabled	Setting range: 0: Invalid 1: valid	Mfr's value: 0
------	----------------------------	------------------------------------	----------------

FC37	Frequency at torque lower limit (Hz)	Setting range: 2.00~50.00	Mfr's value: 10.00
FC40	Lower limit torque threshold	Setting range: 0.0~20.0	Mfr's value: 3.0
FC41	Lower limit frequency threshold	Setting range: 1.00~10.00	Mfr's value: 1.00

At torque mode, if frequency is lower than lower limit frequency, the frequency should be adjusted to lower limit frequency.

When 当下限限制频率小于上限速度限时, 只能运行到上限速度限定。

FC38	Filtering time (ms)	Setting range: 0~5000	Mfr's value: 500
------	---------------------	-----------------------	------------------

当给定转矩增大或者负载转矩变小后, 恢复加速时的延时时间。

FC39	Torque max value	Setting range: 0.0~300.0	Mfr's value: 250.0
------	------------------	--------------------------	--------------------

FC48 Torque switchover enabled	Setting range: 0: Invalid 1: Valid	Mfr's value: 0
FC49 Current-limiting point 2 (%)	Setting range: F608~200	Mfr's value: 160
FC50 Frequency switchover point 1(Hz)	Setting range: 1.00~FC51	Mfr's value: 10.00
FC51 Frequency switchover point 2(Hz)	Setting range: FC50~F111	Mfr's value: 20.00

FC48 is used to limit max torque or max current during running process. In VF and auto torque promotion mode, it is used to limit current, in vector control mode. It is used to limit torque.

FC49 is the percentage of rated current in VF and auto torque promotion mode. FC49 is the percentage of rated torque in vector control mode.

FC50 and FC51 is frequency switchover point when torque or current change. Please see below Fig.

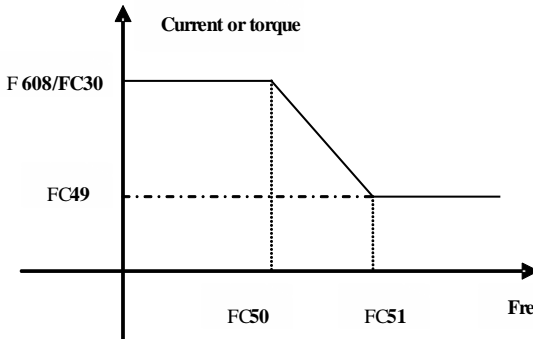

6.14 Parameters of the second motor

Please refer to Appendix 6 for the related function code, and please refer to F8 section for parameters explanations.

6.15 Parameters display

H000 Running frequency/target frequency(Hz)		
---	--	--

In stopped status, target frequency is displayed. In running status, running frequency is displayed.

H001 Actual speed/target speed (rpm)		
--------------------------------------	--	--

In stopped status, actual speed is displayed. In running status, target speed is displayed.

H002 Output current (A)		
-------------------------	--	--

In running status, output current is displayed. In stopped status, H002=0.

H003 Output voltage (V)		
-------------------------	--	--

In running status, output voltage is displayed. In stopped status, H003=0.

H004 Bus voltage (V)		
----------------------	--	--

Bus voltage is displayed by H004.

H005 PID feedback (%)		
-----------------------	--	--

PID feedback value is displayed by H005.

H006	Temperature (°C)		
Inverter temperature is displayed by H006.			
H007	Count value		
The count value of DI1 input impulse is displayed by H007.			
H008	linear speed		
Inverter linear speed is displayed by H008.			
H009	PID setting value (%)		
PID setting value is displayed by H009.			
H010	Yarn length		
H011	central frequency (Hz)		
Yarn length and central frequency are displayed by H010 and H011.			
H012	Output power (KW)		
Inverter output power is displayed by H012.			
H013	Output torque (%)		
H014	Target torque (%)		
Inverter output torque is displayed by H013 and target torque is displayed by H014.			
H015	Encoder phase sequence adjustment		
H015 is used to test whether the encoder direction is same with setting direction, please refer to F854.			
H016	Limit-voltage reference value		
H016 is used to display limit-voltage reference value.			
H017	Current stage speed for multi-stage speed		
In multi-stage speed mode, current stage speed is displayed by H017.			
H018	Frequency of input pulse		
Input pulse frequency of DI1 terminal is displayed by H018, the unit is 0.01			
H019	Feedback speed (Hz)		
H020	Feedback speed (rpm)		
Feedback speed is displayed as frequency by H019. Feedback speed is displayed as speed by H020.			
H021	AI1 voltage (digital)		
H022	AI2 voltage (digital)		
H023	AI3 voltage (digital)		
Analog input voltage is display by H021, H022 and H023.			
H025	Current power-on time (minute)		
H026	Current running time (minute)		
Current power-on time and running time are displayed by H025 and H026.			
H027	Input pulse frequency(Hz)		
Input pulse frequency is displayed by H027, the unit is 1Hz.			
H030	Main frequency source X (Hz)		

H031	Accessorial frequency source Y(Hz)		
------	------------------------------------	--	--

Main frequency and accessorial frequency are displayed by H030 and H031.

H033	Torque sent by master		
H034	Frequency sent by master		
H035	Quantity of slaves		

H033 is used to display percentage of rated torque.

H034 is used to display the frequency sent by master.

H035 is used to display the quantity of slaves.

H036	Accumulative power-on time		
H037	Accumulative running time		

Appendix 1 Trouble Shooting

When malfunction occurs to inverter, don't run by resetting immediately. Check any causes and get it removed if there is any.

Take counter measures by referring to this manual in case of any malfunctions on inverter. Should it still be unsolved, contact the manufacturer. Never attempt any repairing without due authorization.

Table 1-1 Inverter's Common Cases of Malfunctions

Fault	Description	Causes	Countermeasures
Err0	Prohibition modify function code	* prohibition modify the function code during running process.	* Please modify the function code in stopped status.
Err1	Wrong password	*Enter wrong password when password is valid * Do not enter password when modifying function code.	* Please enter the correct password.
2: O.C.	Over-current	* too short acceleration time	*prolong acceleration time;
16: OC1	Over-current 1	* short circuit at output side * locked rotor with motor	*whether motor cable is broken; *check if motor overloads;
67: OC2	Over-current 2	* Too heavy load. * parameter tuning is not correct.	*reduce V/F compensation value * measure parameter correctly.
3: O.E.	DC Over-Voltage	*supply voltage too high; *load inertia too big *deceleration time too short; *motor inertia rise again * bad effect of dynamic braking *parameter of rotary speed loop PID is set abnormally.	*check if rated voltage is input; *add braking resistance(optional); *increase deceleration time * Enhancing the dynamic braking effect *set the parameter of rotary speed loop PID correctly. * Change to VF control for centrifugal fan.
4: P.F1.	Input Phase loss	*phase loss with input power	*check if power input is normal; *check if parameter setting is correct.
5: O.L1	Inverter Overload	* load too heavy	*reduce load; *check drive ratio; *increase inverter's capacity
6: L.U.	Under-Voltage Protection	*input voltage on the low side	*check if supply voltage is normal *check if parameter setting is correct.
7: O.H.	Radiator Overheat	*environment temperature too high; *radiator too dirty *install place not good for ventilation; *fan damaged * Carrier wave frequency or compensation curve is too high.	*improve ventilation; *clean air inlet and outlet and radiator; *install as required; *change fan * Decrease carrier wave frequency or compensation curve.
8: O.L2	Motor Overload	* load too heavy	*reduce load; *check drive ratio; *increase motor's capacity
11: ESP	External fault	*External emergency-stop terminal is valid.	*Check external fault.
12: Err3	Current malfunction before running	*Current alarm signal exists before running.	*check if control board is connected with power board well. *ask for help from manufacture.
13: Err2	Parameters tuning wrong	* Do not connect motor when measuring parameters	*please connect motor correctly.

15: Err4	Current zero excursion malfunction	*Flat cable is loosened. *Current detector is broken.	*check the flat cable. *ask for help from manufacture.
17: PF0	Output Phase loss	* Motor is broken * Motor wire is loose. * Inverter is broken	* check if wire of motor is loose. * check if motor is broken.
18: AErr	Line disconnected	* Analog signal line disconnected * Signal source is broken.	* Change the signal line. * Change the signal source.
19: EP3	Inverter under-load	* Water pump dries up. * Belt is broken. * Equipment is broken.	* Supply water for pump * Change the belt. * Repair the equipment.
20: EP/EP2			
22: nP	Pressure control	* Pressure is too high when negative feedback. * Pressure is too low when positive feedback. * Inverter enters into the dormancy status.	* Decrease the min frequency of PID. * Reset inverter to normal status.
23: Err5	PID parameters are set wrong.	* PID parameters are set wrong.	* Set the parameters correctly.
26: GP	Earth fault protection (T2 does not have GP protection)	*Motor cable is damaged, short connected to grounding. *Motor isolation is damaged, short connected to grounding. *inverter fault.	*change a new cable. *repair the motor. *contact manufacturer.
27: PG	Encoder fault	*Encoder installation fault *Encoder fault *Encoder line number setting fault	*Check the installation and connection *Check encoder *Setting F851 correctly
32: PCE	PMSM distuning fault	*motor parameters measurement is wrong. *load is too heavy.	* Measure motor parameters correctly. * Decrease the load.
35: OH1	PTC overheat protection	*external relay protection.	*check external heat protection equipment.
44: Er44	Master loses slave's response	*communication fault between master and slave	* check wiring. *check baud rate *check communication parameters setting
45: CE	Communication timeout error	Communication fault	*PC/PLC does not send command at fixed time *Check whether the communication line is connected reliably.
47: EEEP	EEPROM read/write fault	*interference around *EEPROM is damaged.	* remove interferences *contact manufacturer.
49: Err6	Watchdog fault	*Watchdog timeout	*please check watchdog signal
53: CE 1	Keypad disconnection protection	*Keypad disconnection	*Check communication line
55: Er55	Off load protection	*external device is disconnected	*Check external device

Table 1-2 **Motor Malfunction and Counter Measures**

Malfunction	Items to Be Checked	Counter Measures
Motor not Running	Wiring correct? Setting correct? Too big with load? Motor is damaged? Malfunction protection occurs?	Get connected with power; Check wiring; Checking malfunction; Reduce load; Check against Table 1-1
Wrong Direction of Motor Running	U, V, W wiring correct? Parameters setting correct?	To correct wiring Setting the parameters correctly.
Motor Turning but Speed Change not Possible	Wiring correct for lines with given frequency? Correct setting of running mode? Too big with load?	To correct wiring; To correct setting; Reduce load
Motor Speed Too High or Too Low	Motor's rated value correct? Drive ratio correct? Inverter parameters are set in-corrected? Check if inverter output voltage is abnormal?	Check motor nameplate data; Check the setting of drive ratio; Check parameters setting; Check V/F Characteristic value
Motor Running Unstable	Too big load? Too big with load change? Phase loss? Motor malfunction.	Reduce load; reduce load change, increase capacity; Correct wiring.
Power Trip	Wiring current is too high?	Check input wiring; Selecting matching air switch; Reduce load; checking inverter malfunction.

Appendix 2 Reference wiring of water system

1. Fixed mode of 1 inverter driving 2 pumps

Instructions of wiring:

1. Please connect the wiring according to above wiring, after checking the wiring and close MCCB3.

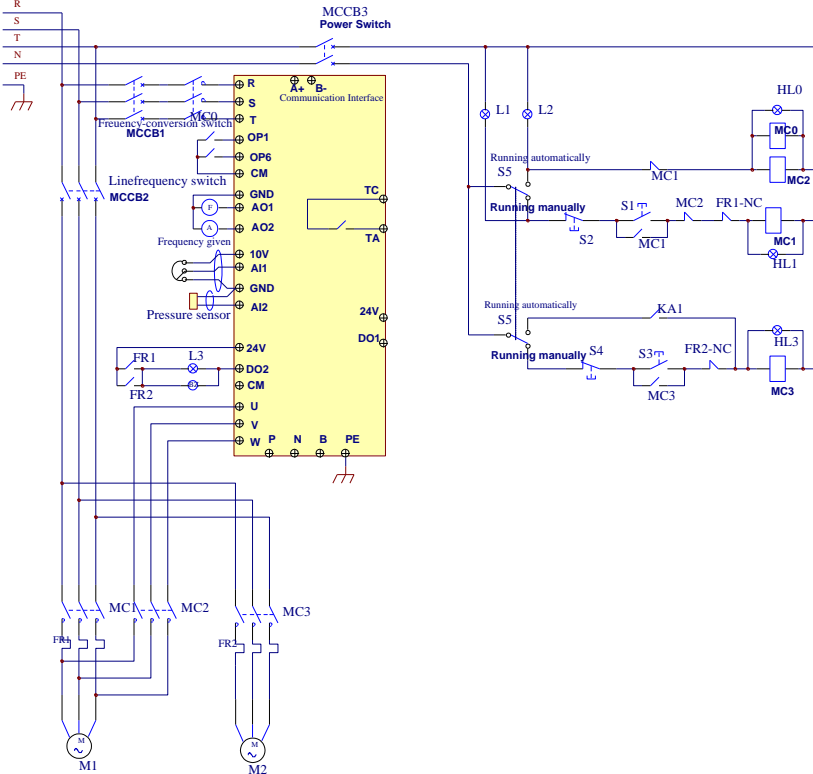

2. Please set F208=1, F203=9, FA00=1, FA36=1, FA37=1, FA47=1, FA48=2, FA04=pressure percentage, FA03=channel limit pressure, and FA05.
3. In manual status, please close power-frequency switch MCCB2. When pressing S1, pump M1 starts working. When pressing S2, M1 stops working. When pressing S3, M2 starts working. When pressing S4, M2 stops working.
4. In automatic status, please close converter-frequency switch MCCB1 and power-frequency switch MCCB2.
 - When inverter is powered on, inverter will run forward by short-connecting DI3 terminal (or run reverse by short-connecting DI4 terminal), M1 will work at power frequency status.
 - If the pressure is not high enough, inverter will accelerate to max frequency. If the pressure is still not high enough after duration time FA31, inverter will free stop and pump M2 will start working at power frequency status. After the duration time of FA30, inverter will start working and M1 works at converter frequency status.
 - When two pumps work at the same time, if pressure is too high, inverter will decelerate to min frequency. If the pressure is still too high after the duration time FA32, M2 will stop working.
 - If one pump M1 works at converter frequency status and inverter works at the min frequency, inverter

will free stop after the duration time FA10, inverter will enter into dormancy status and nP is displayed.

5. Rotating mode of 1 inverter driving 2 pumps

Instructions of wiring:

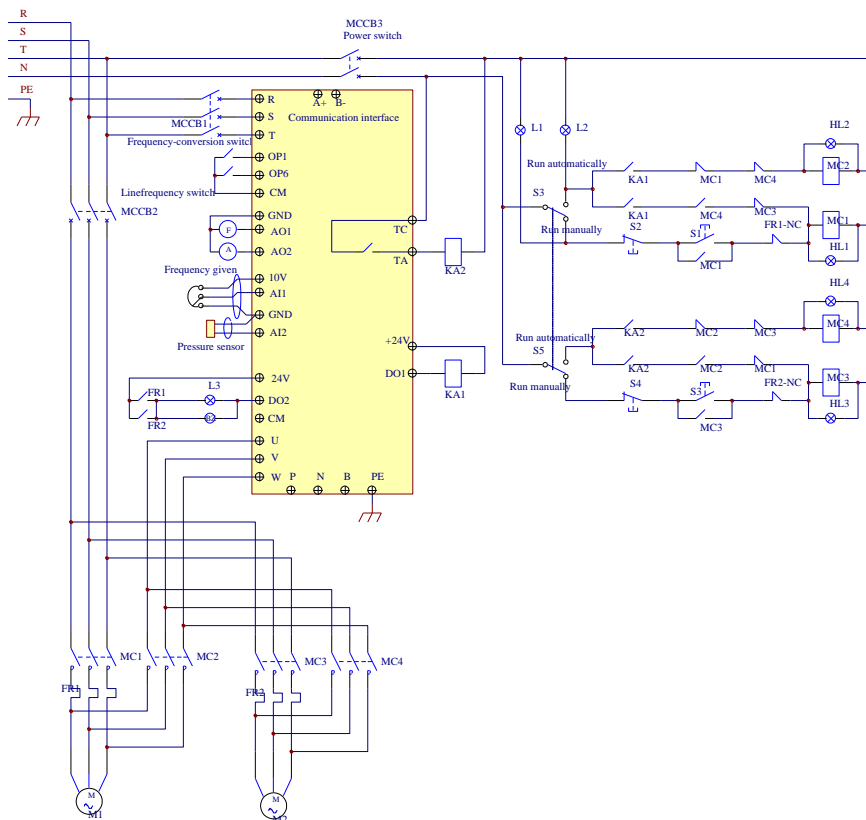

1. Please connect the wiring according to above wiring, after checking the wiring and close MCCB3.
2. Please set F208=1, F203=9, FA00=2, FA36=1, FA37=1, FA47=1, FA48=2, FA04=pressure percentage, FA03=channel limit pressure, and FA05
3. In manual status, please close power-frequency switch MCCB2. When pressing S1, pump M1 starts working. When pressing S2, M1 stops working. When pressing S3, M2 starts working. When pressing S4, M2 stops working.
4. In automatic status, please close converter-frequency switch MCCB1 and power-frequency switch MCCB2.
 - When inverter is powered on, KA1 is “action”, and inverter will run forward by short-connecting DI3 terminal, KA2 makes M1 start working at converter frequency status. If the pressure is not high enough, inverter will accelerate to max frequency. If the pressure is still not high enough after duration time FA31, inverter will free stop and pump M2 will start working at power frequency status. After the duration time of FA30, inverter will start working and M1 works at converter frequency

status.

- After the duration time FA25, all pumps will free stop, then KA2 is “action”, M2 is converter pump. If the pressure is not high enough, inverter will accelerate to max frequency. If the pressure is still not high enough after duration time FA31, inverter will free stop and KA1 makes M1 start working at power frequency status. After the duration time of FA30, inverter will start working and M2 works at converter frequency status.
- When two pumps work at the same time, if pressure is too high, inverter will decelerate to min frequency. If the pressure is still too high after the duration time FA32, general pump will stop working.
- If one pump works at converter frequency status and inverter works at the min frequency, inverter will free stop after the duration time FA10, inverter will enter into dormancy status and nP is displayed.

Appendix 3 Products & Structures

E2000 series inverter has its power range between 0.2~800kW. Refer to Tables 3-1 and 3-2 for main data. There may be two (or more than two) kinds of structures for certain products. Please make a clear indication when placing your order.

Inverter should operate under the rated output current, with overload permitted for a short time. However, it shall not exceed the allowable values at working time.

Table 3-1 **Product List of E2000**

Model	Applicable Motor (kW)	Rated Current Output	Structure Code	Cooling Mode	Remarks
E2000-0002S2	0.2	1.5	E1	Air-Cooling	1-phase plastic housing
E2000-0004S2	0.4	2.5	E1	Air-Cooling	
E2000-0007S2	0.75	4.5	E1	Air-Cooling	
E2000-0015S2	1.5	7.0	E1	Air-Cooling	
E2000-0022S2	2.2	10.0	E2	Air-Cooling	
E2000-0002T2	0.2	1.5	E1	Air-Cooling	3-phase 220V plastic housing
E2000-0004T2	0.4	2.5	E1	Air-Cooling	
E2000-0007T2	0.75	4.5	E1	Air-Cooling	
E2000-0015T2	1.5	7	E1	Air-Cooling	
E2000-0022T2	2.2	10	E2	Air-Cooling	
E2000-0030T2	3.0	12	E3	Air-Cooling	
E2000-0040T2	4.0	17	E4	Air-Cooling	
E2000-0055T2	5.5	21	E5	Air-Cooling	
E2000-0075T2	7.5	30	E6	Air-Cooling	
E2000-0110T2	11	40	E6	Air-Cooling	
E2000-0150T2	15	55	C3	Air-Cooling	
E2000-0185T2	18.5	66	C3	Air-Cooling	
E2000-0220T2	22	76	C3	Air-Cooling	
E2000-0300T2	30	104	C4	Air-Cooling	
E2000-0370T2	37	130	C5	Air-Cooling	
E2000-0450T2	45	155	C5	Air-Cooling	
E2000-0550T2	55	190	C6	Air-Cooling	
E2000-0750T2	75	260	C7	Air-Cooling	
E2000-0007T3	0.75	2.0	E1	Air-Cooling	3-phase 380V plastic housing
E2000-0015T3	1.5	4.0	E1	Air-Cooling	
E2000-0022T3	2.2	6.5	E2	Air-Cooling	
E2000-0030T3	3.0	7.0	E2	Air-Cooling	
E2000-0040T3	4.0	9.0	E2	Air-Cooling	
E2000-0055T3	5.5	12.0	E4	Air-Cooling	
E2000-0075T3	7.5	17.0	E4	Air-Cooling	
E2000-0110T3	11	23.0	E5	Air-Cooling	
E2000-0150T3	15	32.0	E5	Air-Cooling	

E2000-0185T3	18.5	38.0	E6	Air- Cooling	
E2000-0220T3	22	44.0	E6	Air- Cooling	
E2000-0300T3	30	60	E6	Air-Cooling	
E2000-0370T3	37	75	E7	Air- Cooling	
E2000-0450T3	45	90	E7	Air- Cooling	
E2000-0550T3	55	110	C5	Air-Cooling	3-phase 380V metal housing
E2000-0750T3	75	150	C5	Air- Cooling	
E2000-0900T3	90	180	C6	Air- Cooling	
E2000-1100T3	110	220	C6	Air-Cooling	
E2000-1320T3	132	265	C6	Air- Cooling	
E2000-1600T3	160	320	C7	Air- Cooling	
E2000-1850T3	185	360	C8	Air-Cooling	
E2000-2000T3	200	400	C9	Air- Cooling	
E2000-2200T3	220	440	C9	Air- Cooling	
E2000-2500T3	250	480	CA	Air-Cooling	
E2000-2800T3	280	530	CA	Air- Cooling	
E2000-3150T3	315	580	CB0	Air- Cooling	
E2000-3550T3	355	640	CB0	Air-Cooling	
E2000-4000T3	400	690	CB	Air- Cooling	
E2000-1100T3	110	220	DC6	Air- Cooling	
E2000-1320T3	132	265	DD0	Air-Cooling	
E2000-1600T3	160	320	DD0	Air- Cooling	
E2000-1850T3	185	360	DD1	Air- Cooling	
E2000-2000T3	200	400	DD1	Air-Cooling	
E2000-2200T3	220	440	DD1	Air- Cooling	
E2000-2500T3	250	480	DD2	Air- Cooling	
E2000-2800T3	280	530	DD2	Air-Cooling	
E2000-3150T3	315	580	DD2	Air- Cooling	
E2000-3550T3	355	640	DD2	Air- Cooling	
E2000-4000T3	400	690	DD3	Air-Cooling	
E2000-4500T3	450	770	DD3	Air- Cooling	
E2000-5000T3	500	860	DD4	Air- Cooling	
E2000-5600T3	560	950	DD4	Air-Cooling	
E2000-6300T3	630	1100	DD4	Air- Cooling	
E2000-7100T3	710	1300	D6	Air- Cooling	
E2000-8000T3	800	1500	D6	Air- Cooling	

Table 3-2 Structure List

Structure Code	External Dimension [A×B(B1)×H] ^{note1}	Mounting Size(W×L)	Mounting Bolt	Remarks
E1	80×135 (142) ×138(153)	70×128	M4	Plastic Housing
E2	106×150 (157) ×180(195)	94×170	M4	
E3	106×170 (177) ×180(195)	94×170	M4	
E4	142×152 (159) ×235(248)	126×225	M5	
E5	161×170 (177) ×265(280)	146×255	M5	
E6	210×196 (203) ×340(358)	194×330	M5	
E7	265×235(242)×435(465)	235×412	M6	
C3	265×235×435	235×412	M6	Metal Housing
C4	315×234×480	274×465	M6	
C5	360×265×555	320×530	M8	
C6	410×300×630	370×600	M10	
C7	516×326×765	360×740	M10	
C8	560×342×910	390×882	M10	
C9	400×385×1310	280×1282	M10	
CA	535×380×1340	470×1310	M10	
CB0	600×380×1463	545×1433	M10	
CB	600×380×1593	545×1563	M10	
DC6	440×318×1050	360×240	M10	Metal cabinet
DD0	500×450×1450	400×370	M12	
DD1	600×500×1650	500×420	M12	
DD2	660×500×1650	560×420	M12	
DD3	800×600×2050	700×510	M12	
DD4	1200×600×2250	892×394	M16	
D6	1700×600×2355	1489×394	M16	

Note 1: the unit is mm.

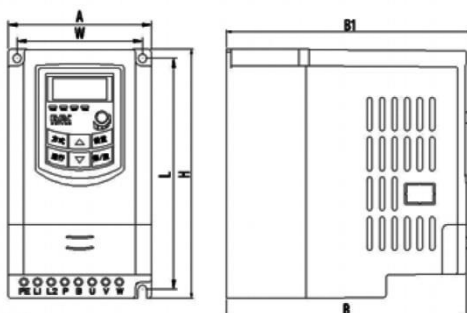

Plastic Profile

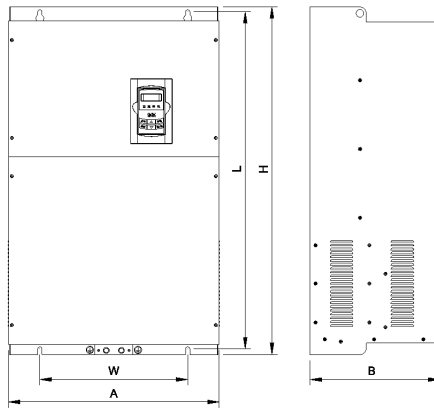

Metal Hanging Profile

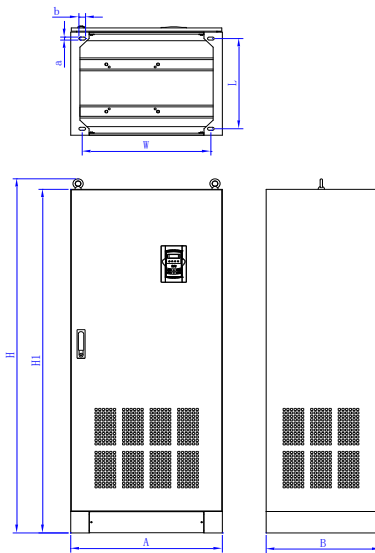

Metal Cabinet profile

Note1: if keypad control unit has potentiometer, the external dimension is B1.

If keypad control unit has no potentiometer, the external dimension is B.

Appendix 4 Selection of Braking Resistance

Inverter Models	Applicable Motor Power (kW)	Min resistor value (Ω)	Min power of resistor (W)	Recommended resistor/power
E2000-0004S2	0.4	80	200W	150 Ω /300W
E2000-0007S2	0.75			
E2000-0015S2	1.5			80 Ω /500W
E2000-0022S2	2.2			
E2000-0002T2	0.2	80	200W	150 Ω /300W
E2000-0004T2	0.4			
E2000-0007T2	0.75			
E2000-0015T2	1.5		300W	80 Ω /500W
E2000-0022T2	2.2			
E2000-0030T2	3.0			
E2000-0040T2	4.0			
E2000-0055T2	5.5	30	400W	30 Ω /1kW
E2000-0075T2	7.5	30	550W	
E2000-0110T2	11	15	1.1kW	15 Ω /2kW
E2000-0150T2	15	15	1.5kW	
E2000-0185T2	18.5	15	2.0kW	
E2000-0220T2	22	15	2.0kW	
E2000-0300T2	30	10	4.0kW	
E2000-0370T2	37	10	4.0kW	10 Ω /4kW
E2000-0450T2	45	7.5	4.0kW	Two 15 Ω /2kW in parallel
E2000-0550T2	55	5	7.5kW	Two 10 Ω /4kW in parallel
E2000-0750T2	75	3	9.0kW	3 Ω /9kW
E2000-0007T3	0.75	145	80W	300 Ω /300W
E2000-0015T3	1.5	95	150W	150 Ω /30W
E2000-0022T3	2.2	95	250W	
E2000-0030T3	3.0	90	300W	90 Ω /1.5kW
E2000-0040T3	4.0	90	400W	
E2000-0055T3	5.5	90	550W	
E2000-0075T3	7.5	90	750W	
E2000-0110T3	11	50	1.1kW	50 Ω /1.5kW
E2000-0150T3	15	30	1.5kW	30 Ω /3kW
E2000-0185T3	18.5	30	2.0kW	
E2000-0220T3	22	30	2.2kW	
E2000-0300T3	30	25	3.0kW	
E2000-0370T3	37	25	3.0kW	
E2000-0450T3	45	15	4.0kW	

E2000

E2000-0550T3	55	15	4.0kW	15Ω/4kW
E2000-0750T3	75	12	6.0kW	12Ω/6kW
E2000-0900T3	90	8	9.0kW	8Ω/9kW
E2000-1100T3	110	8	9.0kW	

Note: in the occasion of large inertia load, if the braking resistor heat is serious, please adopt the larger power of resistor than recommended resistor.

Appendix 5 Communication Manual

(Version 1.8)

I. General

Modbus is a serial and asynchronous communication protocol. Modbus protocol is a general language applied to PLC and other controlling units. This protocol has defined an information structure which can be identified and used by a controlling unit regardless of whatever network they are transmitted.

You can read reference books or ask for the details of MODBUS from manufactures.

Modbus protocol does not require a special interface while a typical physical interface is RS485.

II. Modbus Protocol

2.1 Transmission mode

2.1.1 Format

1) ASCII mode

Start	Address	Function	Data				LRC check		End	
:	Inverter Address	Function Code	Data Length	Data 1	...	Data N	High-order byte of LRC	Low-order byte of LRC	Return (0X0D)	Line Feed (0X0A)

2) RTU mode

Start	Address	Function	Data	CRC check		End
T1-T2-T3-T4	Inverter Address	Function Code	N data	Low-order byte of CRC	High-order byte of CRC	T1-T2-T3-T4

2.1.2 ASCII Mode

In ASCII mode, one Byte (hexadecimal format) is expressed by two ASCII characters.

For example, 31H (hexadecimal data) includes two ASCII characters '3(33H)', '1(31H)'.

Common characters, ASCII characters are shown in the following table:

Characters	'0'	'1'	'2'	'3'	'4'	'5'	'6'	'7'
ASCII Code	30H	31H	32H	33H	34H	35H	36H	37H
Characters	'8'	'9'	'A'	'B'	'C'	'D'	'E'	'F'
ASCII Code	38H	39H	41H	42H	43H	44H	45H	46H

2.1.3 RTU Mode

In RTU mode, one Byte is expressed by hexadecimal format. For example, 31H is delivered to data packet.

2.2 Baud rate

Setting range: 1200, 2400, 4800, 9600, 19200, 38400, 57600

2.3 Frame structure:

ASCII mode

Byte	Function
1	Start Bit (Low Level)
7	Data Bit
0/1	Parity Check Bit (None for this bit in case of no checking. Otherwise 1 bit)
1/2	Stop Bit (1 bit in case of checking, otherwise 2 bits)

2) RTU mode

Byte	Function
1	Start Bit (Low Level)
8	Data Bit
0/1	Parity Check Bit (None for this bit in case of no checking. Otherwise 1 bit)
1/2	Stop Bit (1 bit in case of checking, otherwise 2 bits)

2.4 Error Check

2.4.1 ASCII mode

Longitudinal Redundancy Check (LRC): It is performed on the ASCII message field contents excluding the 'colon' character that begins the message, and excluding the CRLF pair at the end of the message. The LRC is calculated by adding together successive 8-bit bytes of the message, discarding any carries, and then two's complementing the result.

A procedure for generating an LRC is:

1. Add all bytes in the message, excluding the starting 'colon' and ending CRLF. Add them into an 8-bit field, so that carries will be discarded.
2. Subtract the final field value from FF hex (all 1's), to produce the ones-complement.
3. Add 1 to produce the two's-complement.

2.4.2 RTU Mode

Cyclical Redundancy Check (CRC): The CRC field is two bytes, containing a 16-bit binary value. The CRC is started by first preloading a 16-bit register to all 1's. Then a process begins of applying successive 8-bit bytes of the message to the current contents of the register. Only the eight bits of data in each character are used for generating the CRC. Start and stop bits, and the parity bit, do not apply to the CRC.

A procedure for generating a CRC-16 is:

1. Load a 16-bit register with FFFF hex (all 1's). Call this the CRC register.
2. Exclusive OR the first 8-bit byte of the message with the high-order byte of the 16-bit CRC register, putting the result in the CRC register.
3. Shift the CRC register one bit to the right (toward the LSB), zero-filling the MSB. Extract and examine the LSB.
4. (If the LSB was 0): Repeat Step 3 (another shift).

(If the LSB was 1): Exclusive OR the CRC register with the polynomial value A001 hex (1010 0000 0000 0001).

5. Repeat Steps 3 and 4 until 8 shifts have been performed. When this is done, a complete 8-bit byte will have been processed.

When the CRC is appended to the message, the low-order byte is appended first, followed by the high-order byte.

2.4.3 Protocol Converter

It is easy to turn a RTU command into an ASCII command followed by the lists:

- 1) Use the LRC replacing the CRC.
- 2) Transform each byte in RTU command into a corresponding two byte ASCII. For example: transform 0x03 into 0x30, 0x33 (ASCII code for 0 and ASCII code for 3).
- 3) Add a 'colon' (:) character (ASCII 3A hex) at the beginning of the message.
- 4) End with a 'carriage return – line feed' (CRLF) pair (ASCII 0D and 0A hex).

So we will introduce RTU Mode in followed part. If you use ASCII mode, you can use the up lists to convert.

2.5 Command Type & Format

2.5.1 The listing below shows the function codes.

code	name	description
03	Read Holding Registers	Read the binary contents of holding registers in the slave. (Less than 10 registers once time)
06	Preset Single Register	Preset a value into holding register

2.5.2 Address and meaning

The part introduces inverter running, inverter status and related parameters setting.

Description of rules of function codes parameters address:

- 1) Use the function code as parameter address

General Series:

High-order byte: 01~0A (hexadecimal)

Low-order byte: 00~50 (max range) (hexadecimal) Function code range of each partition is not the same. The specific range refers to manual.

For example: parameter address of F114 is 010E (hexadecimal).

parameter address of F201 is 0201 (hexadecimal).

For H section, please convert H0 to 43.

For example: the address of H014 is 430E.

Note: in this situation, it allows to read six function codes and write only one function code. Some function codes can only be checked but cannot be modified; some function codes can neither be checked nor be modified; some function codes cannot be modified in run state; some function codes cannot be modified both in stop and run state.

In case parameters of all function codes are changed, the effective range, unit and related instructions shall refer to user manual of related series of inverters. Otherwise, unexpected results may occur.

- 2) Use different parameters as parameter address

(The above address and parameters descriptions are in hexadecimal format, for example, the decimal digit 4096 is represented by hexadecimal 1000).

1. Running status parameters

Parameters Address	Parameter Description (read only)
1000	Output frequency
1001	Output voltage
1002	Output current

1003	Pole numbers/ control mode, high-order byte is pole numbers, low-order byte is control mode.
1004	Bus-line voltage
1005	<p>Drive ratio/inverter status High-order byte is drive ratio, low-order byte is inverter status Inverter status:</p> <p>0X00: Standby mode 0X01: Forward running 0X02: Reverse running 0X04: Over-current (OC) 0X05: DC over-current (OE) 0X06: Input Phase loss (PF1) 0X07: Frequency Over-load (OL1) 0X08: Under-voltage (LU) 0X09: Overheat (OH) 0X0A: Motor overload (OL2) 0X0B: Interference (Err) 0X37:CE1 0X0D: External Malfunction (ESP) 0X0E: Err3 0X0F: Err2 0X11: Err4 0X12: OC1 0X13:PF0 0X14: Analog disconnected protection (AErr) 0X15: EP3 0X16: under-load (EP) 0X17: PP 0X18: Pressure control protection (Np) 0X19: PID parameters are set incorrectly (Err5) 0x1A: Sleeping status (SLP) 0x21: Motor overheat (OH4) 0x25: PTC overheat protection (OH1) 0X2F: Communication timeout (CE) 0X31: Watchdog fault (Err6) 0X34: oPEn fault 0X36: STO 0X48: STO1</p>
1006	The percent of output torque
1007	Inverter radiator temperature
1008	PID given value
1009	PID feedback value
100A	Read integer power value
100B	DI terminal status: DI1~DI8—bit0~bit7
100C	Terminal output status : bit0-OUT1 bit1-OUT2 bit2-fault relay
100D	AI1: 0~4095 read input analog digital value
100E	AI2: 0~4095 read input analog digital value
100F	AI3: 0~4095 read input analog digital value
1010	Reserved
1011	0~100.00% the percent of input pulse
1012	0~100.00% the percent of output pulse
1013	<p>Monitoring in which stage speed inverter is.</p> <p>0000 : no function 0001 : stage speed 1 0010 : stage speed 2 0011 : stage speed 3 0100 : stage speed 4 0101 : stage speed 5 0110 : stage speed 6 0111 : stage speed 7 1000 : stage speed 8 1001 : stage speed 9 1010 : stage speed 10 1011 : stage speed 11 1100 : stage speed 12 1101 : stage speed 13 1110 : stage speed 14 1111 : stage speed 15</p>

1014	Monitoring external counting value
1015	Monitoring analog output percent, AO1 (0~100.00)
1016	Monitoring analog output percent, AO2 (0~100.00)
1017	Monitoring current speed.
1018	Read accurate power value, and correct the power to 1 decimal place.
101A	Output current(when the current is too high, data overflow from 1002) 101A: high 16 bits of output current 101B: low 16 bits of output current
101B	
101C	Transmission ratio
101D	Inverter is ready.

1. Control commands

Parameters Address	Parameters Description (write only)
2000	Command meaning: 0001: Forward running (no parameters) 0002: Reverse running (no parameters) 0003: Deceleration stop 0004: Free stop 0005: Forward jogging start 0006: Forward jogging stop 0007: Reserved 0008: Run (no directions) 0009: Fault reset 000A: Forward jogging stop 000B: Reverse jogging stop 000C: Wakeup
2001	Lock parameters 0001: Relieve system locked (remote control locked) 0002: Lock remote control (any remote control commands are no valid before unlocking) 0003: RAM and eeprom are permitted to be written. 0004: Only RAM is permitted to be written, eeprom is prohibited being written.
2002	AO1 output percent is set by PC/PLC. Setting range: 0~1000 Token output analog is 0~100.0%.
2003	AO2 output percent is set by PC/PLC. Setting range: 0~1000 Token output analog is 0~100.0%.
2004	FO output percent is set by PC/PLC. Setting range: 0~1000 FO token output pulse is 0~100.0%.
2005	To control multi-function output terminal: 1 means token output is valid. 0 means token output is invalid.
2006	
2007	
2009	Voltage is set by PC/PLC when V/F separation.

2. Illegal Response When Reading Parameters

Command Description	Function	Data
Slave parameters response	The highest-order byte changes into 1.	Command meaning: 0001: Illegal function code 0002: Illegal address 0003: Illegal data 0004: Slave fault ^{note 2}

Note 2: Illegal response 0004 appears below two cases:

1. Do not reset inverter when inverter is in the malfunction state.
2. Do not unlock inverter when inverter is in the locked state.

2.5.3 Additional Remarks

Expressions during communication process:

Parameter Values of Frequency=actual value X 100 (General Series)
 Parameter Values of Frequency=actual value X 10 (Medium Frequency Series)
 Parameter Values of Time=actual value X 10
 Parameter Values of Current=actual value X 10
 Parameter Values of Voltage=actual value X 1
 Parameter Values of Power=actual value X 100
 Parameter Values of Drive Ratio=actual value X 100
 Parameter Values of Version No. =actual value X 100

Instruction: Parameter value is the value sent in the data package. Actual value is the actual value of inverter. After PC/PLC receives the parameter value, it will divide the corresponding coefficient to get the actual value.

NOTE: Take no account of radix point of the data in the data package when PC/PLC transmits command to inverter. The valid value is range from 0 to 65535.

III Function Codes Related to Communication

Function Code	Function Definition	Setting Rang	Mfr's Value
F200	Source of start command	0: Keypad command; 1: Terminal command; 2: Keypad+Terminal; 3:MODBUS; 4: Keypad+Terminal+MODBUS	4
F201	Source of stop command	0: Keypad command; 1: Terminal command; 2: Keypad+Terminal; 3:MODBUS; 4: Keypad+Terminal+MODBUS	4
F203	Main frequency source X	0: Digital setting memory; 1: External analog AI1; 2: External analog AI2; 3: Pulse input given; 4: Stage speed control; 5: No memory by digital setting; 6:Keypad potentiometer AI3; 7: Reserved; 8: Reserved; 9: PID adjusting; 10: MODBUS	0
F900	Inverter Address	1~255	1

F901	Modbus Mode Selection	1: ASCII mode 2: RTU mode 3: Remote keypad	2
F903	Parity Check	0: Invalid 1: Odd 2: Even	0
F904	Baud Rate	0: 1200 1: 2400 2: 4800 3: 9600 4: 19200 5: 38400 6: 57600	3

Please set functions code related to communication consonant with the PLC/PC communication parameters, when inverter communicates with PLC/PC.

IV Physical Interface

4.1 Interface instruction

Communication interface of RS485 is located on the most left of control terminals, marked underneath with A+ and B-

4.2 Structure of Field Bus

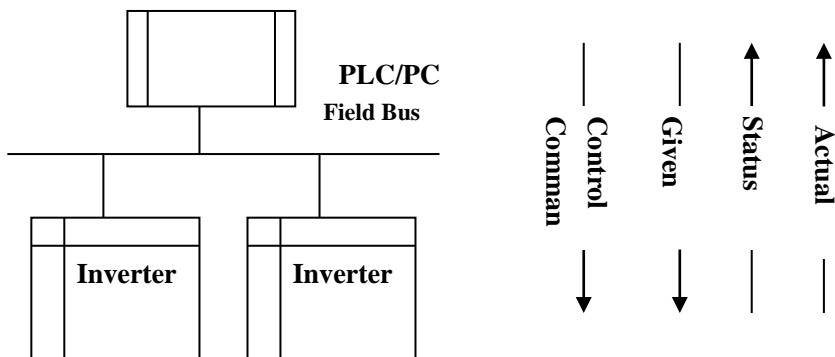

Connecting Diagram of Field Bus

RS485 Half-duplex communication mode is adopted for E2000 series inverter. Daisy chain structure is adopted by 485 Bus-line. Do not use 'spur' lines or a star configuration. Reflect signals which are produced by spur lines or star configuration will interfere in 485 communications.

Please note that for the same time in half-duplex connection, only one inverter can have communication with PC/PLC. Should two or more than two inverters upload data at the same time, then bus competition will occur, which will not only lead to communication failure, but higher current to certain elements as well.

4.3. Grounding and Terminal

Terminal resistance of $120\ \Omega$ will be adopted for terminal of RS485 network, to diminish the reflection of signals. Terminal resistance shall not be used for intermediate network.

No direct grounding shall be allowed for any point of RS485 network. All the equipment in the network shall be well grounded via their own grounding terminal. Please note that grounding wires will not form closed loop in any case.

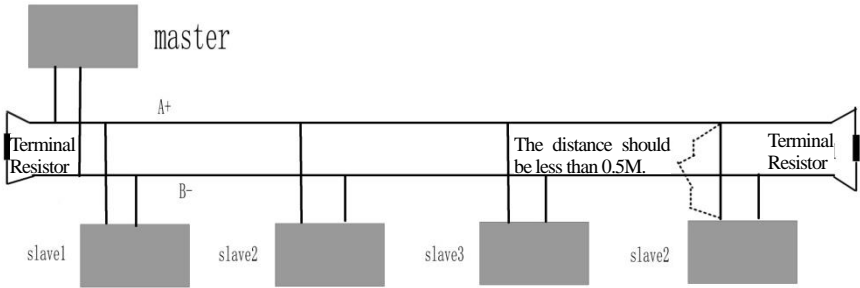

Connecting Diagram of Terminal Resistance

Please think over the drive capacity of PC/PLC and the distance between PC/PLC and inverter when wiring. Add a repeaters if drive capacity is not enough.



All wiring connections for installation shall have to be made when the inverter is disconnected from power supply.

V. Examples

Eg1: In RTU mode, change acc time (F114) to 10.0s in NO.01 inverter.

Query

Address	Function	Register Address Hi	Register Address Lo	Preset Data Hi	Preset Data Lo	CRC Lo	CRC Hi
01	06	01	0E	00	64	E8	1E

Function code F114

Value: 10.0S

Normal Response

Address	Function	Register Address Hi	Register Address Lo	Response Data Hi	Response Data Lo	CRC Lo	CRC Hi
01	06	01	0E	00	64	E8	1E

Function code F114

Normal Response

Abnormal Response

Address	Function	Abnormal code	CRC Lo	CRC Hi
01	86	04	43	A3

The max value of function code is 1. Slave fault

Eg 2: Read output frequency, output voltage, output current and current rotate speed from N0.2 inverter.

Host Query

Address	Function	First Register Address Hi	First Register Address Lo	Register count Hi	Register count L0	CRC Lo	CRC Hi
02	03	10	00	00	04	40	FA

Communication Parameters Address 1000H

Slave Response :

Address	Function	Byte Count	Data Hi	Data Lo	Data Hi	Data Lo	Data Hi	Data Lo	Data Hi	Data Lo	Crc Lo	Crc Hi
02	03	08	13	88	01	90	00	3C	02	00	82	F6

Output Frequency Output Voltage Output Current Numbers of Pole Pairs Control Mode

NO.2 Inverter's output frequency is 50.00Hz, output voltage is 380V, output current is 0.6A, numbers of pole pairs are 2 and control mode keypad control.

Eg 3: NO.1 Inverter runs forwardly.

Host Query:

Address	Function	Register Hi	Register Lo	Write status Hi	Write status Lo	CRC Lo	CRC Hi
01	06	20	00	00	01	43	CA

Communication parameters address 2000H

Forward running

Slave Normal Response:

Address	Function	Register Hi	Register Lo	Write status Hi	Write status Lo	CRC Lo	CRC Hi
01	06	20	00	00	01	43	CA

Normal Response

Slave Abnormal Response:

Address	Function	Abnormal Code	CRC Lo	CRC Hi
01	86	01	83	A0

The max value of function code is 1. Illegal function code (assumption)

Eg4: Read the value of F113, F114 from NO.2 inverter

Host Query :

Address	Function	Register Address Hi	Register Address Lo	Register Count Hi	Register Count L0	CRC Lo	CRC Hi
02	03	01	0D	00	02	54	07

Communication Parameter Address F10DH

Numbers of Read Registers

Slave Normal Response:

Address	Function	Byte count	The first parameters status Hi	The first parameters status Lo	The second parameters status Hi	The second parameters status Lo	CRC Lo	CRC Hi

02	03	04	03	E8	00	78	49	61
----	----	----	----	----	----	----	----	----

The actual value is 10.00.

The actual value is 12.00.

Slave Abnormal Response:

Address	Function Code	Abnormal Code	CRC Lo	CRC Hi
02	83	08	B0	F6

The max value of function code is 1.

Parity check fault

Appendix 6 Zoom Table of Function Code

Basic parameters: F100-F160

Function Code	Function Definition	Setting Range	Mfr's Value	Change
F100	User's Password	0~9999	0	√
F102	Inverter's Rated Current (A)		Subject to inverter model	△
F103	Inverter Power (kW)		Subject to inverter model	△
F104	Voltage level		Subject to inverter model	△
F105	Software Edition No.	1.00~10.00	Subject to inverter model	△
F106	Control mode	0: Sensorless vector control (SVC); 1: Closed-loop vector control (VC); 2: V/F; 3: Vector control 1 6: PMSM sensorless vector control	2	×
F107	Password Valid or Not	0: invalid; 1: valid 2: Invalid for communication 3: Menu lock screen enabled	0	√
F108	Setting User's Password	0~9999	8	√
F109	Starting Frequency (Hz)	0.0~10.00	0.00	√
F110	Holding Time of Starting Frequency (S)	0.0~999.9	0.0	√
F111	Max Frequency (Hz)	F113~590.0	50.00	√
F112	Min Frequency (Hz)	0.00~F113	0.50	√
F113	Target Frequency (Hz)	F112~F111	50.00	√
F114	1 st Acceleration Time (S)	0.1~3000	subject to inverter model	√
F115	1 st Deceleration Time (S)	0.1~3000		√
F116	2 nd Acceleration Time (S)	0.1~3000		√
F117	2 nd Deceleration Time (S)	0.1~3000		√
F118	Turnover Frequency (Hz)	1.00~590.0	50.00	×○
F119	Reference of setting accel/decel time	0: 0~50.00Hz 1: 0~max frequency 2: 0~target frequency	0	×
F120	Forward/Reverse Switchover dead-Time	0.0~3000S	0.0	√
F121	V/F extra compensation	0: invalid; 1: valid	0	×
F122	Reverse Running Forbidden	0: invalid; 1: valid	0	×
F123	Minus frequency is valid in the mode of combined speed control.	0: Invalid; 1: valid	0	×

F124	Jogging Frequency	F112~F111	5.00	√
F125	Jogging Acceleration Time	0.1~3000S	subject to inverter model	√
F126	Jogging Deceleration Time	0.1~3000S		√
F127	Skip Frequency A	0.00~590.0	0.00	√
F128	Skip Width A	0.00~2.50	0.00	√
F129	Skip Frequency B	0.00~590.0	0.00	√
F130	Skip Width B	0.00~2.50	0.00	√
F131	Running Display Items	0—Present output frequency / function code 1—Current output rotary speed 2—Output current 4—Output voltage 8—PN voltage 16—PID feedback value 32—Temperature 64—Count values 128—Linear speed 256—PID given value 512—Yarn length 1024—Center frequency 2048—Output power 4096— Output torque	0+1+2+4+8=15	√
F132	Display items of stop	0: frequency / function code 1: Keypad jogging 2: Target rotary speed 4: PN voltage 8: PID feedback value 16: Temperature 32: Count values 64: PID given value 128: Yarn length 256: Center frequency 512: Setting torque	2+4=6	√
F133	Drive Ratio of Driven System	0.10~200.0	1.0	√
F134	Transmission-wheel radius	0.001~1.000	0.001	√
F135	User macro	0: Invalid 1: user macro 1 2: user macro 2	0	×
F136	Slip compensation	0~10	0	×

F137	Modes of torque compensation	0: Linear compensation; 1: Square compensation; 2: User-defined multipoint compensation 3: Auto torque compensation 4: V/F separation	3	×
F138	Linear compensation	1~20	subject to inverter model	×
F139	Square compensation	1: 1.5; 2: 1.8; 3: 1.9; 4: 2.0	1	×
F140	Voltage compensation point frequency	0.00~F142	1.00	×
F141	Voltage compensation point 1 (%)	0~30	0	×
F142	User-defined frequency point 2	F140~F144	5.00	×
F143	User-defined voltage point 2	0~100	13	×
F144	User-defined frequency point 3	F142~F146	10.00	×
F145	User-defined voltage point 3	0~100	24	×
F146	User-defined frequency point 4	F144~F148	20.00	×
F147	User-defined voltage point 4	0~100	45	×
F148	User-defined frequency point 5	F146~F150	30.00	×
F149	User-defined voltage point 5	0~100	63	×
F150	User-defined frequency point 6	F148~F118	40.00	×
F151	User-defined voltage point 6	0~100	81	×
F152	Output voltage corresponding to turnover frequency	10~100	100	×
F153	Carrier frequency setting	subject to inverter model	subject to inverter model	×
F154	Automatic voltage rectification	Setting range: 0: Invalid 1: Valid 2:Invalid during deceleration process	0	×
F155	Digital accessory frequency setting	0.00~F111	0	√
F156	Digital accessory frequency polarity setting	0~1	0	√
F157	Reading accessory frequency			△

F158	Reading accessory frequency polarity			△
F159	Random carrier-wave frequency selection	0: Control speed normally; 1: Random carrier-wave frequency	1	
F160	Reverting to manufacturer values	0: Invalid 1: Valid 21: revert user macro 1 22: revert user macro 2	0	×

Running control mode: F200-F230

F200	Source of start command	0: Keypad command; 1: Terminal command; 2: Keypad+Terminal; 3:MODBUS; 4: Keypad+Terminal+MODBUS	4	×
F201	Source of stop command	0: Keypad command; 1: Terminal command; 2: Keypad+Terminal; 3:MODBUS; 4: Keypad+Terminal+MODBUS	4	×
F202	Mode of direction setting	0: Forward running locking; 1: Reverse running locking; 2: Terminal setting 3: Keypad setting 4: Keypad setting and direction in memory	0	×
F203	Main frequency source X	0: Digital setting memory; 1: External analog AI1; 2: External analog AI2; 3: Pulse input given; 4: Stage speed control; 5: No memory by digital setting; 6:Keypad potentiometer AI3; 7: Reserved; 8: Reserved; 9: PID adjusting; 10: MODBUS	0	×
F204	Accessory frequency source Y	0: Digital setting memory; 1: External analog AI1; 2: External analog AI2; 3: Pulse input given; 4: Stage speed control; 5: PID adjusting; 6: Keypad potentiometer AI3;	0	×

F205	Reference for selecting accessorial frequency source Y range	0: Relative to max frequency; 1: Relative to main frequency X	0	×
F206	Accessorial frequency Y range	0~150	100	×
F207	Frequency source selecting	0: X; 1: X+Y; 2: X or Y (terminal switchover); 3: X or X+Y (terminal switchover); 4: Combination of stage speed and analog 5: X-Y 6: X+Y-Y _{MAX} *50% 7: combination 1 of stage speed and digital 9: X/Y 10: Max(X,Y) 11: Min(X,Y)	0	×
F208	Terminal two-line/three-line operation control	0: No function; 1: Two-line operation mode 1; 2: Two-line operation mode 2; 3: three-line operation mode 1; 4: three-line operation mode 2; 5: start/stop controlled by direction pulse	0	×
F209	Selecting the mode of stopping the motor	0: stop by deceleration time; 1: free stop 2: Stop by DC braking	0	×
F210	Frequency display accuracy	0.01~10.00	0.01	√
F211	Speed of digital control	0.01~100.00	5.00	√
F212	Direction memory	0: Invalid 1: Valid	0	√
F213	Auto-starting after repowered on	0: invalid; 1: valid	0	√
F214	Auto-starting after reset	0: invalid; 1: valid	0	√
F215	Auto-starting delay time	0.1~3000	60.0	√
F216	Times of auto-starting in case of repeated faults	0~5	0	√
F217	Delay time for fault reset	0.0~3000.0	3.0	√
F219	EEPROM write operation	0:enabled to write 1:prohibit writing	1	√
F220	Frequency memory after power-down	0: invalid; 1: valid	0	√

F221	X+Y-50% (%)	0~200	50	√
F222	count memory selection	0: Invalid 1: Valid	0	√
F223	Main frequency coefficient	0.0~100.0	100.0	√
F224	When target frequency is lower than Min frequency	0: stop 1: run at min frequency	0	×
F226	Action of skipping frequency	0: no action during accel/decel 1: no action during decelerating 2. valid at any time	0	×
F233	Accel/decel time unit	0: 0.1s 1: 0.01s	0	√
F234	switchover frequency during deceleration process (Hz)	0.00: invalid 0.00~F111	0.00	×

Traverse Operating function: F235-F280

F235	Traverse operating mode	0: Invalid 1: Traverse operating mode 1 2: Traverse operating mode 2 3: Traverse operating mode 3	0	×
F236	Crawl-positioning	0: Disabled 1: Enabled	0	√
F237	Traverse signal source	0: Auto start 1: X terminal	0	
F238	Stop mode of length arrival	0: Stop the motor at fixed length 1: Stop the motor at fixed spindle radius 2: Non-stop at fixed length, it indicates full of yarn. 3: Fixed radius arrival, it indicates full of yarn.	0	×
F239	Traverse memory mode	0: Memory at the status of stop and power off 1: Only memory at the status of stop. 2: Only memory at the status of power off. 3: No memory.	0	√
F240	Preset frequency (Hz)	F112~F111	5.00	√
F241	Running time of preset frequency (S)	0~3000	0	√
F242	Central frequency (Hz)	F243~F111	25.00	√
F243	Lower limit of central frequency (Hz)	F112~F242	0.50	√
F244	Descending rate of central frequency (Hz / S)	0.100~65.000	0.500	√

F245-F246	Reserved			
F247	Traverse amplitude setting mode	0: Relative to max frequency 1: Relative to central frequency	1	×
F248	Traverse amplitude	0~100.00%	10.00	√
F249	Jump frequency	0~50.00%	30.00	√
F250	Rising time of traverse (S)	0.1~3000	10.0	√
F251	Descending time of traverse (S)	0.1~3000	10.0	√
F252	Crawl-positioning frequency (Hz)	F112~F111	3.00	√
F253	Waiting time of crawl-positioning (S)	0.0~3000	5.0	√
F254	Max time of crawl-positioning (S)	0.0~3000	10.0	√
F255-F256	Reserved			
F257	Cumulative length (Km)	0.00~6500.0	0.0	√
F258	Actual length (Km)	0.000~65.000	0.000	√
F259	Setting length (Km)	0.000~65.000	0.000	√
F260	Pulse numbers of length sensor	0.01~650.0	1.00	√
F262	Clear yarn broken signal	0: stop and refer to yarn broken signal 1: refer to yarn broken signal	0	√
F264	Feedback channel of fixed radius	0: AI1 1: AI2	0	√
F265	Fixed-radius display value	0~10000	1000	√
F266	Output voltage at fixed radius mode (V)	0~10.00	5.00	√
F267	Voltage hysteresis when judging full of yarn signal is clear.	0~10.00	0	√
F269	DI pre-alarm current	Read only	read only	△
F270	DI pre-alarm current threshold	0.01~6.00	0.50	√
F271	DI pre-alarm current delay time	5~60	30	√
F272	Delay time of yarn broken and yarn intertwining (S)	0.0~3000.0	0.0	√
F273-F274	Reserved			
F275	Detect frequency value	F112~F111	25.00	√
F276	Detect frequency width	0.00~20.00	0.50	√
F277	Third Acceleration Time (S)	Setting range: 0.1~3000	subject to inverter model	√
F278	Third Deceleration Time (S)			√
F279	Fourth Acceleration Time (S)			√
F280	Fourth Deceleration Time (S)			√

Multifunctional Input and Output Terminals: F300-F330

F300	Relay token output		1	√
F301	DO1 token output		14	√
F302	DO2 token output		5	
F303	DO output types selection	0: level output 1 : pulse output	0	√
F304	S curve beginning stage proportion	2.0~50.0	30.0	√
F305	S curve ending stage proportion	2.0~50.0	30.0	√
F306	Accel/decel mode	0: Straight-line 1: S curve	0	×
F307	Characteristic frequency 1	F112~F111	10.00	√
F308	Characteristic frequency 2	F112~F111	50.00	√
F309	Characteristic frequency width (%)	0~100	50	√
F310	Characteristic current (A)	0~5000.0	Rated current	√
F311	Characteristic current width (%)	0~100	10	√
F312	Frequency arrival threshold (Hz)	0.00~5.00	0.00	√
F313	Count frequency divisions	1~65000	1	√
F314	Set count value	F315~65000	1000	√
F315	Designated count value	1~F314	500	√
F316	DI1 terminal function setting	0: no function; 1: running terminal; 2: stop terminal; 3: multi-stage speed terminal 1; 4: multi-stage speed terminal 2; 5: multi-stage speed terminal 3; 6: multi-stage speed terminal 4; 7: reset terminal; 8: free stop terminal; 9: external emergency stop terminal; 10: acceleration/deceleration forbidden terminal; 11: forward run jogging; 12: reverse run jogging; 13: UP frequency increasing terminal; 14: DOWN frequency decreasing terminal; 15: "FWD" terminal; 16: "REV" terminal; 17: three-line type input "X" terminal;	11	√
F317	DI2 terminal function setting		9	√
F318	DI3 terminal function setting		15	√
F319	DI4 terminal function setting		16	√
F320	DI5 terminal function setting		7	√
F321	DI6 terminal function setting		8	√

F322	DI7 terminal function setting	18: accel/decel time switchover 1; 19: Reserved; 20: Switchover between speed and torque 21: frequency source switchover terminal;	0	√
F323	DI8 terminal function setting	22: Count input terminal; 23: Count reset terminal 24: clear traverse status 25: Traverse operating mode is valid. 26: yarn broken 27: intertwining yarn 28: crawl-positioning signal 29: clear actual yarn length and traverse status 30: Water lack signal; 31: Signal of water 32: Fire pressure switchover; 33: Emergency fire control 34: Accel / decel switchover 2 37: Common-open PTC heat protection 38: Common-close PTC heat protection 41: DI pre-alarm current enable 42: oPEn protection terminal. 49: PID paused 51: Motor switchover 53: Watchdog 54: Frequency reset 60: Communication timeout 2 61: Start-stop terminal	0	√
F324	Free stop terminal logic	0: positive logic (valid for low level);	0	×
F325	External emergency stop terminal logic	1: negative logic (valid for high level)	0	×
F326	Watchdog time	0.0~3000.0	10.0	√
F327	Stop mode	0: Free stop 1: Deceleration to stop	0	×
F328	Terminal filter times	1~100	20	√
F329	Run command of start terminal	0: Valid 1: Invalid	0	√
F330	Diagnostics of DIX terminal			√
F331	Monitoring AI1		Read only	
F332	Monitoring AI2		Read only	

F333	Monitoring AI3		Read only	
F335	Relay output simulation	Setting range:	0	×
F336	DO1 output simulation	0: Output active.	0	×
F337	DO2 output simulation	1: Output inactive.	0	×
F338	AO1 output simulation	Setting range: 0~4095	0	×
F339	AO2 output simulation	Setting range: 0~4095	0	×
F340	Selection of terminal negative logic	0: Invalid 1: DI1 negative logic 2: DI2 negative logic 4: DI3 negative logic 8: DI4 negative logic 16: DI5 negative logic 32: DI6 negative logic 64: DI6 negative logic 128: DI8 negative logic	0	√
F343	Delay time of DI1 ON	0.00~99.99	0.00	√
F344	Delay time of DI2 ON		0.00	√
F345	Delay time of DI3 ON		0.00	√
F346	Delay time of DI4 ON		0.00	√
F347	Delay time of DI5 ON		0.00	√
F348	Delay time of DI6 ON		0.00	√
F349	Delay time of DI7 ON		0.00	√
F350	Delay time of DI8 ON		0.00	√
F351	Delay time of DI1 OFF		0.00	√
F352	Delay time of DI2 OFF		0.00	√
F353	Delay time of DI3 OFF		0.00	√
F354	Delay time of DI4 OFF		0.00	√
F355	Delay time of DI5 OFF		0.00	√
F356	Delay time of DI6 OFF		0.00	√
F357	Delay time of DI7 OFF		0.00	√
F358	Delay time of DI8 OFF		0.00	√
F359	Stop command priority	0: Invalid 1: Valid	0	√

F360	DO terminal negative logic	0: Invalid 1: DO1 negative logic 2: DO2 negative logic 4: Relay 1	0	√
------	----------------------------	--	---	---

Analog Input and Output: F400-F480

F400	Lower limit of AI1 channel input (V)	0.00~F402	0.04	○
F401	Corresponding setting for lower limit of AI1 input	0.00~2.00	1.00	√
F402	Upper limit of AI1 channel input (V)	F400~10.00	10.00	○
F403	Corresponding setting for upper limit of AI1 input	0.00~2.00	2.00	√
F404	AI1 channel proportional gain K1	0.0~10.0	1.0	√
F405	AI1 filtering time constant (S)	0.01~10.0	0.10	√
F406	Lower limit of AI2 channel input (V)	0.00~F408	0.04	○
F407	Corresponding setting for lower limit of AI2 input	0.00~2.00	1.00	√
F408	Upper limit of AI2 channel input (V)	F406~10.00	10.00	○
F409	Corresponding setting for upper limit of AI2 input	0.00~2.00	2.00	√
F410	AI2 channel proportional gain K2	0.0~10.0	1.0	√
F411	AI2 filtering time constant	0.01~10.00	0.10	√
F412	Lower limit of AI3 channel input	0.00~F414	0.05	○
F413	Corresponding setting for lower limit of AI3 input	0.00~2.00	1.00	√
F414	Upper limit of AI3 channel input	F412~10.0	10.0	○
F415	Corresponding setting for upper limit of AI3 input	0.00~2.00	2.00	√
F416	AI3 channel proportional gain K1	0.0~10.0	1.0	√
F417	AI3 filtering time constant	0.01~10.00	0.10	√
F418	AI1 channel 0Hz voltage dead zone	0.00~1.00	0.00	√
F419	AI2 channel 0Hz voltage dead zone	0.00~1.00	0.00	√
F420	AI3 channel 0Hz voltage dead zone	0.00~1.00	0.00	√
F421	Panel selection	0: Local keypad panel 1: Remote control keypad panel 2: local keypad + remote control keypad	1	√

F422	Potentiometer selection	0: Potentiometer in local panel 1: Potentiometer in remote control panel	0	√
F423	AO1 output range	0: 0~5V; 1: 0~10V or 0-20mA	1	√
F424	AO1 lowest corresponding frequency	0.0~F425	0.05	√
F425	AO1 highest corresponding frequency	F424~F111	50.00	√
F426	AO1 output compensation	0~120	100	√
F427	AO2 output range	0: 0~20mA; 1: 4~20mA	0	√
F428	AO2 lowest corresponding frequency	0.0~F429	0.05	√
F429	AO2 highest corresponding frequency	F428~F111	50.00	√
F430	AO2 output compensation	0~120%	100	√
F431	AO1 analog output signal selecting	0: Running frequency; 1: Output current; 2: Output voltage; 3: AI1 4: AI2 5: Input pulse 6: Output torque 7: Given by PC/PLC 8: Target frequency 9: Speed 10: Output torque 2 11: Reserved 12: Output power 13: DO2 output	0	√
F432	AO2 analog output signal selecting		1	√
F433	Corresponding current for full range of external voltmeter	0.01~5.00 times of rated current	2.00	×
F434	Corresponding current for full range of external ammeter		2.00	×
F435	Corresponding multiple of rated power for output max analog value	0.01~3.00	2.00	×
F436	Corresponding current multiple of rated torque for output max analog	0.01~3.00	3.00	×
F438	Input signal of AI1 channel	Setting range: 0: voltage 1: current	0	×
F439	Input signal of AI2 channel	Setting range: 0: voltage 1: current	1	×
F440	Min frequency of input pulse FI	0.00~F442	0.00	√
F441	Corresponding setting of FI min frequency	0.00~F443	1.00	√
F442	Max frequency of input pulse FI	F440~100.00	10.00	√

F443	Corresponding setting of FI max frequency	Max (1.00, F441) ~2.00	2.00	√
F444	Reserved			
F445	Filtering constant of FI input pulse	0~100	0	√
F446	FI channel 0Hz frequency dead zone	0~F442Hz (Positive-Negative)	0.00	√
F447- F448	Reserved			
F449	Max frequency of output pulse FO	0.00~100.00	10.00	√
F450	Zero bias coefficient of output pulse frequency (%)	0.0~100.0	0.0	√
F451	Frequency gain of output pulse	0.00~10.00	1.00	√
F452	Reserved			
F453	Output pulse signal	0: Running frequency 1: Output current 2: Output voltage 3: AI1 4: AI2 5: Input pulse 6: Output torque 7: Given by PC/PLC 8: Target frequency	0	√
F460	AI1 channel input mode	0: straight line mode 1: folding line mode	0	×
F461	AI2 channel input mode	0: straight line mode 1: folding line mode	0	×
F462	AI1 insertion point A1 voltage value	F400~F464	2.00	×
F463	AI1 insertion point A1 setting value	0.00~2.00	1.20	×
F464	AI1 insertion point A2 voltage value	F462~F466	5.00	×
F465	AI1 insertion point A2 setting value	0.00~2.00	1.50	×
F466	AI1 insertion point A3 voltage value	F464~F402	8.00	×
F467	AI1 insertion point A3 setting value	0.00~2.00	1.80	×
F468	AI2 insertion point B1 voltage value	F406~F470	2.00	×
F469	AI2 insertion point B1 setting value	0.00~2.00	1.20	×
F470	AI2 insertion point B2 voltage value	F468~F472	5.00	×
F471	AI2 insertion point B2 setting value	0.00~2.00	1.50	×
F472	AI2 insertion point B3 voltage value	F470~F412	8.00	×
F473	AI2 insertion point B3 setting value	0.00~2.00	1.80	×
F475	AO1 deviation compensation		1.00	√
F476	AO2 deviation compensation		1.00	√
F477	User-define speed control mode	0: invalid 1: valid	0	×
F478	Max limit of output frequency	F113~F111	50.00	√

Multi-stage Speed Control: F500-F580

F500	Stage speed type	0: 3-stage speed; 1: 15-stage speed; 2: Max 8-stage speed auto circulating	1	×
F501	Selection of Stage Speed Under Auto-circulation Speed Control	2~8	7	√
F502	Selection of Times of Auto- Circulation Speed Control	0~9999 (when the value is set to 0, the inverter will carry out infinite circulating)	0	√
F503	Status after auto circulation running Finished	0: Stop 1: Keep running at last stage speed	0	√
F504	Frequency setting for stage 1 speed	F112~F111	5.00	√
F505	Frequency setting for stage 2 speed	F112~F111	10.00	√
F506	Frequency setting for stage 3 speed	F112~F111	15.00	√
F507	Frequency setting for stage 4 speed	F112~F111	20.00	√
F508	Frequency setting for stage 5 speed	F112~F111	25.00	√
F509	Frequency setting for stage 6 speed	F112~F111	30.00	√
F510	Frequency setting for stage 7 speed	F112~F111	35.00	√
F511	Frequency setting for stage 8 speed	F112~F111	40.00	√
F512	Frequency setting for stage 9 speed	F112~F111	5.00	√
F513	Frequency setting for stage 10 speed	F112~F111	10.00	√
F514	Frequency setting for stage 11 speed	F112~F111	15.00	√
F515	Frequency setting for stage 12 speed	F112~F111	20.00	√
F516	Frequency setting for stage 13 speed	F112~F111	25.00	√
F517	Frequency setting for stage 14 speed	F112~F111	30.00	√
F518	Frequency setting for stage 15 speed	F112~F111	35.00	√
F519-F533	Acceleration time setting for the speeds from Stage 1 to stage 15	0.1~3000S	Subject to inverter model	√
F534-F548	Deceleration time setting for the speeds from Stage 1 to stage 15	0.1~3000S		√
F549-F556	Running directions of stage speeds from Stage 1 to stage 8	0: forward running; 1: reverse running	0	√
F557-F564	Running time of stage speeds from Stage 1 to stage 8	0.1~3000S	1.0	√
F565-F572	Stop time after finishing stages from Stage 1 to stage 8.	0.0~3000S	0.0	√
F573-F579	Running directions of stage speeds from Stage 9 to stage 15.	0: forward running; 1: reverse running	0	√
F580	Stage-speed mode	0: Stage speed mode 1	0	√

Auxiliary Functions: F600-F677

F600	DC Braking Function Selection	0: Invalid; 1: braking before starting; 2: braking during stopping; 3: braking during starting and stopping	0	√
F601	Initial Frequency for DC Braking	0.20~50.00	1.00	√
F602	DC Braking efficiency before Starting	0~250 for 30kW and below 30kW	50	√
F603	DC Braking efficiency During Stop	0~200 for above 30kW	100	√
F604	Braking Lasting Time Before Starting	0.0~30.00	0.50	√
F605	Braking Lasting Time During Stopping	0.0~30.00	0.50	√
F607	Selection of Stalling Adjusting Function	Setting range: 0~2: Reserved 3: Voltage/current control 4: Voltage control 5: Current control	3	√
F608	Stalling Current Adjusting (%)	25~FC49	160	√
F609	Stalling Voltage Adjusting (%)	110~200	Mfr's value: 1-phase: 130 3-phase: 140	√
F610	Stalling Protection Judging Time (S)	0.0~3000.0	60.0	√
F611	Dynamic Braking threshold (V)	T3: 600~2000 S2/T2: 320~2000	Subject to inverter model	△
F612	Dynamic braking duty ratio (%)	0~100	100	×
F613	Speed track	0: invalid 1: valid for induction motor 2: valid for induction motor at the first time 3: speed mode 1 for PM motor 4: speed mode 2 for PM motor	0	×
F614	Speed track mode	Setting range: 0: Speed track from frequency memory 1: Speed track from zero 2: Speed track from max frequency	0	×
F615	Speed track rate	1~100	20	×
F618	Delay time of speed track (S)	0.5~60.0	1.5	×
F620	Brake delay turn-off time	0.0 (brake not closed when stop) 0.1~3000	5.0	√
F631	VDC adjustment selection	Setting range:	0	√

		0: invalid 1: valid at stable running 2: reserved 3: valid at any time		
F632	Target voltage of VDC adjusting	Setting range: 100~2300	Subject to inverter model	√
F633	frequency of VDC adjusting	Setting range: 0~100.00	5.00	√
F634	accelerating time of VDC adjusting	Setting range: 0.1~3000.00	0.1	√
F635	decelerating time of VDC adjusting	Setting range: 0.1~3000.00	0.1	√
F636	Proportion Gain of VDC adjusting	Setting range: 0.01~20.00	1.00	√
F637	integration gain of VDC adjusting	Setting range: 0~20.00	1.50	√
F638	Parameters copy enabled	0: Copy forbidden 1: Parameters download 1 (voltage level and power are totally same) 2: Parameters download 2 (without considering voltage level and power)	1	×
F639	Parameters copy code	2000~2999	Subject to version of software	△
F640	Parameter copy type	0: Copy all parameters 1: Copy parameters (except motor parameters from F801 to F810/F844)	1	×
F641	Inhibition of current oscillation at low frequency	0: Invalid 1: Valid	Subject to inverter model	
F643	Multi-functional key	Setting range: 0: Invalid 1: FWD jogging 2: REV jogging 3: Switchover between local/remote 3. Reverse run control	0	×
F644	Keypad copy enabled	Setting range: 0: Invalid 1: current macro parameter upload 2: current macro parameter download 3: user macro 1 upload 4: user macro 1 download 5: user macro 2 upload 6: user macro 2 download	0	×
F645	Status parameters selection	0: Current running frequency 1: Current rotate speed 2: Target rotate speed 3: Output current	0	√

		4: Output voltage 5: PN voltage 6: PID setting value 7: PID feedback value 8: Radiator temperature 9: Count value 10: Linear speed 11: Main frequency setting channel 12: Main frequency 13: Auxiliary frequency setting channel 14: Auxiliary frequency 15: Target frequency 16: Reserved 17: Output torque 18: Setting torque 19: Motor power 20: Output power 21: Frequency status 22: DI terminal status 23: Output terminal status 24: Current stage of multi-stage speed 25: AI1 input value 26: AI2 input value 27, 28: Reserved 29: Pulse input frequency 30: Pulse output frequency 31: AO1 output percentage 32: AO2 output percentage 33: Power-on time		
F646	Backlight time of LCD (S)	0~100	100	√
F647	Language selection	0: Chinese 1: English 2: Deutsch	0	√○
F649	Keypad selection	0: Automatic identification 1: LED remote keypad 2: LCD remote keypad	0	√○
F657	Instantaneous power failure selection	0: Invalid 1: non-stop after power failure 2: decelerate to stop after power failure	0	×
F658	Voltage rally acceleration time	0.0~3000s 0.0: F114	0.0	√
F659	Voltage rally deceleration time	0.0~3000s	0.0	√

		0.0: F115		
F660	Action judging voltage at instantaneous power failure	200~F661	Subject to inverter model	×○
F661	Action stop voltage at instantaneous power failure	F660~1400	Subject to inverter model	×○
F662	Instantaneous voltage recovery judging time(s)	0.00~10.00	0.30	√
F663	Instantaneous proportion coefficient Kp	0.00~10.00	0.25	√
F664	instantaneous integral coefficient Ki	0.00~10.00	0.30	√
F670	Voltage-limit current-limit adjustment coefficient	0.01~10.00	2.00	√
F671	voltage source for V/F separation	0: F672 1: AI1 2: AI2 3: AI3 4: Communication setting 5: pulse setting 6: PID 7~10: reserved	0	×
F672	Voltage digital setting for V/F separation	0.00~100.00	100.00	√
F673	Lower limit of voltage at V/F separation (%)	0.00~F674	0.00	×
F674	Upper limit of voltage at V/F separation (%)	F673~100.00	100.00	×
F675	Voltage rise time of V/F separation (S)	0.0~3000.0	5.0	√
F676	Voltage rise time of V/F separation (S)	0.0~3000.0	5.0	√
F677	Stop mode at V/F separation	0: voltage and frequency declines to 0 according to respective time. 1: Voltage declines to 0 first 2: frequency declines to 0 first.	0	×

Timing Control and Protection: F700-F760

F700	Selection of terminal free stop mode	0: free stop immediately; 1: delayed free stop	0	√
F701	Delay time for free stop and programmable terminal action	0.0~60.0s	0.0	√
F702	Fan control mode	0: controlled by temperature 1: Running when inverter is powered on 2: Controlled by running status	2	×
F704	Inverter Overloading pre-alarm Coefficient (%)	50~100	80	

F705	Overloading adjusting gains	50~100	80	×
F706	Inverter Overloading coefficient%	120~190	150	×
F707	Motor Overloading coefficient %	20~100	100	×
F708	Record of The Latest Malfunction Type	Setting range: 2: Over current (OC) 3: over voltage (OE) 4: input phase loss (PF1) 5: inverter overload (OL1) 6: under voltage (LU) 7: overheat (OH) 8: motor overload (OL2) 11: external malfunction (ESP) 13. studying parameters without motor (Err2) 16: Over current 1 (OC1) 17: output phase loss (PF0) 18: Aerr analog disconnected 20: EP/EP2/EP3 under-load 22: nP pressure control 23: Err5 PID parameters are set wrong 45: Communication timeout (CE) 46: Speed track fault (FL) 49: Watchdog fault (Err6)		△
F709	Record of Malfunction Type for Last but One			△
F710	Record of Malfunction Type for Last but Two			△
F711	Fault Frequency of The Latest Malfunction			△
F712	Fault Current of The Latest Malfunction			△
F713	Fault PN Voltage of The Latest Malfunction			△
F714	Fault Frequency of Last Malfunction but One			△
F715	Fault Current of Last Malfunction but			△
F716	Fault PN Voltage of Last Malfunction			△
F717	Fault Frequency of Last Malfunction			△
F718	Fault Current of Last Malfunction but			△
F719	Fault PN Voltage of Last Malfunction			△
F720	Record of overcurrent protection fault			△
F721	Record of overvoltage protection fault			△
F722	Record of overheat protection fault			△
F723	Record of overload protection fault			△
F724	Input phase loss	0: invalid; 1: valid	S2: 0 T2/T3:1	○×

F725	Under-voltage protection	0: reset manually 1: reset automatically	2	×
F726	Overheat	0: invalid; 1: valid	1	×
F727	Output phase loss	0: invalid; 1: valid	1	×
F728	Input phase loss filtering constant	0.1~60.0	5	√
F729	Under-voltage filtering constant	0.1~60.0	5	√
F730	Overheat protection filtering constant	0.1~60.0	5.0	√
F732	Under-voltage protection voltage threshold (V)	T2/S2: 120~450 T3: 300~450	Subject to inverter model	○
F737	Over-current 1 protection	0: Invalid 1: Valid	1	
F738	Over-current 1 protection coefficient	0.50~3.00	2.50	
F739	Over-current 1 protection record			△
F741	Analog disconnected protection	0: Invalid 1: Stop and AErr displays. 2: Stop and AErr is not displayed. 3: Inverter runs at the min frequency. 4: Reserved.	0	√
F742	Threshold of analog disconnected protection (%)	1~100	50	○
F743	Filtering constant of checking STO	0.1~10.0	0.5	√
F745	Threshold of pre-alarm overheat	0~100	80	√○
F746	Carrier frequency auto-adjusting threshold	60~100	75	√○
F747	Carrier frequency auto-adjusting	0: Invalid 1: Valid	1	√
F751	Instantaneous stop pretreatment enable	0: Invalid 1: Valid	0	√
F752	Overload quitting coefficient	0.1~20.0	1.0	√
F753	Selection of overload protection	0: Normal motor 1: variable frequency motor	1	×
F754	Zero-current threshold (%)	0~200	5	×
F755	Duration time of zero-current	0~60	0.5	√
F759	Carrier-frequency ratio	3~15	7	×
F760	Grounding protection	0: Invalid 1: Valid	0	*
F761	Switchover mode of FWD/REV	0: At zero 2: at start frequency	0	×
F770	Auxiliary version No.			△

Motor parameters: F800-F880

F800	Motor's parameters selection	Setting range: 0: Invalid; 1: Rotating tuning.; 2: Stationary tuning	0	×
F801	Rated power	0.1~1000.0		×
F802	Rated voltage	1~1300		×
F803	Rated current	0.2~6553.5		×
F804	Number of motor poles	2~100	4	×
F805	Rated rotary speed	1~39000		×
F806	Stator resistance	0.001~65.53 Ω (for 15kw and below 15kw) 0.1~6553m Ω (For above 15kw)	Subject to inverter model	×
F807	Rotor resistance	0.001~65.53 Ω (for 15kw and below 15kw) 0.1~6553m Ω (For above 15kw)	Subject to inverter model	×
F808	Leakage inductance	Setting range: 0.01~655.3mH (for 15kw and below 15kw) 0.001~65.53mH (for above 15kw)	Subject to inverter model	×
F809	Mutual inductance	Setting range: 0.1~6553mH (for 15kw and below 15kw) 0.01~655.3mH (for above 15 kw)	Subject to inverter model	×
F810	Motor rated frequency	1.00~650.00	50.00	×
F811	Carrier frequency switchover point (Hz)	0.00~20.00	8.00	√
F812	Pre-exciting time (S)	0.00~30.00	0.10	√
F813	Rotary speed loop KP1	1~100	30	√
F814	Rotary speed loop KI1	0.01~10.00	0.50	√
F815	Rotary speed loop KP2	1~100	Subject to inverter model	√
F816	Rotary speed loop KI2	0.01~10.00	1.00	√
F817	PID switching frequency 1	0~F818	5.00	√
F818	PID switching frequency 2	F817~F111	10.00	√
F819	Slip coefficient	50~200	100	√
F820	Filtering coefficient of speed loop	0~100	0	√

F821	Over-excitation gain	Setting range: 0.0~50.0	Mfr's value: 30.0	√
F822	Upper limit of speed control torque	0.0~250.0	200	√○
F844	Motor current without load	0.1~F803	Subject to model	×○
F847	Encoder disconnection detection time(s)	0.1~10.0	2.0	×
F850	Detection threshold of encoder disconnection	5~100	30	×
F851	Encoder resolution	1~9999	1000	×○
F854	Encoder phase sequence	0: forward direction 1: reverse direction	0	×○
F866	Static position identification	0: Invalid 1: Valid	0	×
F867	Position identification current	0~30	10	×
F868	Position identification frequency	2000~16000	10000	×
F870	PMSM back electromotive force (mV/rpm)	0.1~6553.0 (valid value between lines)	100.0	×○
F871	PMSM D-axis inductance (mH)	0.01~655.35	5.00	×○
F872	PMSM Q-axis inductance (mH)	0.01~655.35	7.00	×○
F873	PMSM stator resistance (Ω)	0.001~65.000 (phase resistor)	0.500	×○
F874	Position identification times	0~1000	0	×
F875	Position identification angle compensation	0.0~100.0	20.0	×
F876	PMSM injection current without load (%)	0.0~100.0	20.0	×○
F877	PMSM injection current compensation without load (%)	0.0~50.0	0.0	×○
F878	PMSM cut-off point of injection current compensation without load (%)	0.0~50.0	10.0	×○
F879	PMSM injection current with heavy load (%)	0.0~100.0	0.0	×○

F880	PMSM PCE detection time (S)	0.0~10.0 S	0.2	×○
------	-----------------------------	------------	-----	----

Communication parameter: F900-F930

F900	Communication Address	1~255: single inverter address 0: broadcast address	1	√
F901	Communication Mode	1: ASCII 2: RTU 3: Remote keypad	2	√○
F902	Stop bits	1~2	2	√
F903	Parity Check	0: Invalid 1: Odd 2: Even	0	√
F904	Baud Rate	0: 1200; 1: 2400; 2: 4800; 3: 9600; 4: 19200 5: 38400 6: 57600	3	√
F905	Communication timeout period (S)	0.0~3000.0	0.0	√
F907	Time 2 of communication timeout (S)	0.0~3000.0	0.0	√
F911	Point-point communication selection	0:Disabled 1:Enabled	0	×
F912	Master and slave selection	0:Master 1:Slave	0	×
F913	Running command of slave	0:Slave not following running commands of master 1:Slave following running commands of master	1	×
F914	Fault information of slave	Ones: slave fault information 0: Not sending fault information 1: Sending fault information Tens: master's reaction when it loses slave's response 0: No reaction 1: Alarm	01	√
F915	Master action when slave failed	0: continue running 1: free stop 2: Deceleration to stop	1	√
F916	Slave action when master stops	1: Free stop 2: Deceleration to stop	1	√

F917	Slave following master command selection	0: given torque(torque) 1: given frequency 1(Droop) 2: given frequency 2 (Droop)	0	×
F918	Zero offset of received data (torque)	0~200.00	100.00	√
F919	Gain of received data(torque)	0.00~10.00	1.000	√
F920	Zero offset of received data (frequency)	0~200.00	100.00	√
F921	Gain of received data(frequency)	0.00~10.00	1.000	√
F922	window	0.00~10.00	0.50	√
F923	Droop control	0.0~30.0	0.00	√
F924	Time of communication timeout (S)	0.0~3000.0	0.0	√
F925	Master sending data interval (S)	0.000~1.000	0.0	√
F926	CAN baud rate (kbps)	0:20 1:50 2:100 3:125 4: 250 5:500 6:1000	6	√
F928	BACnet address	0~127	1	√
F929	BACnet baud rate (bps)	0:9600 1: 19200 2: 38400 3:76800	1	√
F930	Keypad disconnected protection(s)	0~10 0: Invalid	0	√

PID parameters: FA00-FA80

FA00	Water supply mode	0: Single pump (PID control mode) 1: Fixed mode 2: Timing interchanging	0	×
FA01	PID adjusting target given source	0: FA04 1: AI1 2: AI2 3: AI3 (Potentiometer on the keypad) 4: FI (pulse frequency input)	0	×

FA02	PID adjusting feedback given source	1: AI1 2: AI2 3: FI (pulse frequency input) 4: reserved 5: Running current 6: Output power 7: Output torque	1	√
FA03	Max limit of PID adjusting (%)	FA04~100.0	100.0	√
FA04	Digital setting value of PID adjusting (%)	FA05~FA03	50.0	√
FA05	Min limit of PID adjusting (%)	0.0~FA04	0.0	√
FA06	PID polarity	0: Positive feedback 1: Negative feedback	1	×
FA07	Dormancy function selection	0: Valid 1: Invalid	1	×
FA09	Min frequency of PID adjusting (Hz)	Max(F112, 0.1)~F111	5.00	√
FA10	Dormancy delay time (S)	0~500.0	15.0	√
FA11	Wake delay time (S)	0.0~3000	3.0	√
FA12	PID max frequency(Hz)	FA09~F111	50.00	√
FA18	Whether PID adjusting target is changed	0: Invalid 1: Valid	1	×
FA19	Proportion Gain P	0.00~10.00	0.30	√
FA20	Integration time I (S)	0.0~100.0	0.3	√
FA21	Differential time D (S)	0.0~10.0	0.0	√
FA22	PID sampling period (S)	1~500	5	√
FA23	PID negative frequency output selection	0: Invalid 1: Valid	0	√
FA24	Switching Timing unit setting	0: hour 1: minute	0	×
FA25	Switching Timing Setting	1~9999	100	×
FA26	Under-load protection mode	0: No protection 1: Protection by contactor 2: Protection by PID 3: Protection by current	0	×
FA27	Current threshold of under-load protection (%)	10~150	50	√
FA28	Waking time after protection (min)	1~3000	60	√
FA29	PID dead time (%)	0.0~10.0	2.0	√
FA30	Running Interval of restarting converter pump (S)	2.0~999.9s	20.0	√

FA31	Delay time of starting general pumps (S)	0.1~999.9s	30.0	√
FA32	Delay time of stopping general pumps (S)	0.1~999.9s	30.0	√
FA33	stop mode when constant pressure water supply	0: free stop 1: deceleration to stop	0	×
FA36	Whether No.1 relay is started	0: Stopped 1: Started	0	×
FA37	Whether No.2 relay is started	0: Stopped 1: Started	0	×
FA38	Proportion gain Kp2	0.00~10.00	0.30	√
FA39	Integration time Ki2(S)	0.1~100.0	0.3	√
FA40	Differential time Kd2(S)	0.0~10.0	0.0	√
FA41	PI parameter switchover type	0: no switchover 1: reserved 2: Auto switchover 3: reserved	0	×
FA42	Switchover error 1	FA05~FA43	0.0	√
FA43	Switchover error 2	FA42~FA03	0.0	√
FA47	The sequence of starting No 1 relay	1~20	20	×
FA48	The sequence of starting No 2 relay	1~20	20	×
FA58	Fire pressure given value (%)	0.0~100.0	80.0	√
FA59	Emergency fire mode	0: Invalid 1: Emergency fire mode 1 2: Emergency fire mode 2	0	√
FA60	Running frequency of emergency fire	F112~F111	50.00	√
FA62	When fire emergency control terminal is invalid	0~1	0	×○
FA66	Duration time of under-load protection (S)	0~60	1.0	√
FA67	Dormancy mode	0: dormancy mode 1 1: dormancy mode 2	0	×
FA68	Given pressure offset 1 (%)	0.0~100.0	30.0	√
FA69	Given pressure offset 2 (%)	0.0~100.0	30.0	√
FA76	Frequency range of under load(Hz)	Setting range: F112~F113	Mfr's value: 5.00	√
FA77	running mode of under load	Setting range:	Mfr's value: 0	√

Torque control parameters: FC00-FC51

FC00	Speed/torque control selection	0: Speed control 1: Torque control 2: Terminal switchover	0	√
FC02	Torque accel/decel time (S)	0.1~100.0	1.0	√
FC03- FC05	Reserved			
FC06	Torque given channel	0: Digital given (FC09) 1: Analog input AI1 2: Analog input AI2 3: Analog input AI3 4: Pulse input channel FI 5: Reserved	0	×
FC07	Torque given coefficient	0~3.000	3.000	×
FC08	Reserved			
FC09	Torque given command value (%)	0~300.0	100.0	√
FC10- FC13	Reserved			
FC14	Offset torque given channel	0: Digital given (FC17) 1: Analog input AI1 2: Analog input AI2 3: Analog input AI3 4: Pulse input channel FI 5: Reserved	0	×
FC15	Offset torque coefficient	0~0.500	0.500	×
FC16	Offset torque cut-off frequency (%)	0~100.0	10.00	×
FC17	Offset torque command value (%)	0~50.0	10.00	√
FC18- FC21	Reserved			
FC22	Forward speed limited channel	0: Digital given (FC23) 1: Analog input AI1 2: Analog input AI2 3: Analog input AI3 4: Pulse input channel FI 5: Reserved	0	×
FC23	Forward speed limited (%)	0~100.0	10.00	√
FC24	Reverse speed limited channel	0: Digital given (FC25) 1: Analog input AI1 2: Analog input AI2 3: Analog input AI3 4: Impulse input FI	0	×

		5: Reserved		
FC25	Reverse speed limited (%)	0~100.0	10.0	√
FC28	Electric torque limited channel	0: Digital given (FC30) 1: Analog input AI1 2: Analog input AI2 3: Analog input AI3 4: Pulse input channel FI 5: Reserved	0	×
FC29	Electric torque limited coefficient	0~3.000	3.000	×
FC30	Electric torque limited (%)	0~300.0	200.0	√
FC33	Braking torque limited channel	0: Digital given (FC35) 1: Analog input AI1 2: Analog input AI2 3: Analog input AI3 4: Pulse input channel FI 5: Reserved	0	×
FC34	Braking torque limited coefficient	0~3.000	3.000	×
FC35	Braking torque limited (%)	0~300.0	200.00	√
FC48	Torque switchover enabled	0: Invalid 1: Valid	1	×
FC49	Current-limiting point 2 (%)	F608~200	190	√
FC50	Frequency switchover point 1(Hz)	1.00~FC51	10.00	√
FC51	Frequency switchover point 2(Hz)	FC50~F111	20.00	√

The second motor parameters: FE00-FE84

FE00	Motor switchover	Ones: motor selection 0: No. 1 motor 1: No. 2 motor 2: Terminal switchover Tens: control mode of No.2 motor 0: sensorless vector control (SVC) 1: Closed-loop vector control (VC) 2: V/F control 3: vector control 1	20	×
FE01	Rated power of motor 2(kW)	0.1~1000.0	Subject to inverter model	×○
FE02	Rated voltage of motor 2(V)	1~1300		×○
FE03	Rated current of motor 2(A)	0.2~6553.5		×○
FE04	Number of motor 2 poles	2~100	4	×○
FE05	Rated speed of motor 2(rmp)	1~30000	Subject to inverter model	×○
FE06	Motor 2 stator resistor	0.001~65.53Ω (≤15kW) 0.1~6553mΩ(>15kW)	Subject to inverter model	×○
FE07	Motor 2 rotor resistor	0.001~65.53Ω (≤15kW) 0.1~6553mΩ(>15kW)	Subject to inverter model	×○
FE08	Motor 2 leakage inductance	0.01~655.3mH (≤15kW) 0.001~65.53mH (>15kW)	Subject to inverter model	×○
FE09	Motor 2 mutual inductance	0.01~655.3mH (≤15kW) 0.001~65.53mH (>15kW)	Subject to inverter model	×○
FE10	Motor 2 rated frequency(Hz)	1.00~650.00	50.00	×○
FE11	Motor 2 no-load current(A)	0.1~FE03	Subject to inverter model	×○
FE12	Type of motor 2	0: Normal motor 1: variable frequency motor	1	×
FE13	Motor 2 rotary speed loop KP1	1~100	30	√○
FE14	Motor 2 rotary speed loop KI1	0.01~10.00	0.50	√○
FE15	Motor 2 rotary speed loop KP2	1~100	20	√○
FE16	Motor 2 rotary speed loop KI2	0.01~10.00	1.00	√○

FE17	Motor 2 switching frequency 1	0.00~F818	5.00	√
FE18	Motor 2 switching frequency 2	FE17~F111	10.00	√
FE19	Accel/decel time of motor 2	0: same with accel/decal time of motor 1 1: 1 st accel/decal time 2: 2ed accel/decal time	0	√
FE20	Torque compensation of motor 2	1~20	Subject to inverter model	×
FE21	Overload coefficient of motor 2	20~100	100	×
FE22	Motor 2 overloading pre-alarm Coefficient (%)	50~100	80	×
FE23	Motor 2 oscillation inhibition coefficient	0~100	Subject to inverter model	×
FE24	Reserved			
FE25	Motor 2 speed loop filtering constant	0~100	0	√
FE27	Max torque when speed control	0.0~250.0	200.0	√
FE33	Motor 2 record of the latest malfunction type			△
FE34	Motor 2 record of malfunction type for last but one			△
FE35	Motor 2 record of malfunction type for last but two			△
FE36	Motor 2 fault frequency of the latest malfunction(Hz)			△
FE37	Motor 2 fault current of the latest malfunction(A)			△
FE38	Motor 2 fault PN voltage of the latest malfunction(V)			△
FE39	Motor 2 fault frequency of last malfunction but one(Hz)			△
FE40	Motor 2 fault current of last malfunction but one(A)			△
FE41	Motor 2 fault PN voltage of last malfunction but one(V)			△
FE42	Motor 2 fault frequency of last malfunction but two(Hz)			△
FE43	Motor 2 fault current of last malfunction but two(A)			△

FE44	Motor 2 fault PN voltage of last malfunction but two(V)			△
FE45	Motor 2 record of overcurrent protection fault times			△
FE46	Motor 2 record of overvoltage protection fault times			△
FE47	Motor 2 record of overheat protection fault times			△
FE48	Motor 2 record of overload protection fault times			△
FE49	Motor 2 software overcurrent coefficient	0.50~3.00	2.50	×
FE50	Motor 2 software overcurrent times			△
FE51	Motor 2 encoder line numbers	1~9999	1000	×○
FE76	Injection current when no load	0.0~100.0	20.0	×○
FE77	Injection current compensation when no load	0.0~50.0	0.0	×○
FE78	Compensation cut-off point	0.0~50.0	10.0	×○
FE79	Injection current when heavy load	0.0~100.0	0.0	×○
FE80	PCE detecting current	0.1~10.0	0.2	×○
FE81	PMSM speed loop Kp	0.01~30.00	4.00	×○
FE82	PMSM speed loop Ki	0.01~10.00	0.20	×○
FE83	PMSM current loop Kp	0.1~10.0	1.0	×○
FE84	PMSM current loop Ki	0.1~10.0	1.0	×○

IO expansion:

FF00	Expansion relay 1 output	Refer to F300~F302.	0	√
FF01	Expansion relay 2 output		0	√
FF05	Expansion input DIA	Refer to F316~F323.	0	√
FF06	Expansion input DIB		0	√
FF07	Expansion input DIC		0	√

FF08	Expansion input DID		0	√
FF09	Expansion input negative logic selection	0: Invalid 1: DIA negative logic 2: DIB negative logic 4: DIC negative logic 8: DID negative logic	0	√

Parameters display:

H000	Running frequency / target frequency (Hz)			△
H001	Speed with load / target speed			△
H002	Output current (A)			△
H003	Output voltage (V)			△
H004	PN voltage (V)			△
H005	PID feedback value (%)			△
H006	Temperature (°C)			△
H007	Count values			△
H008	Linear speed			△
H009	PID given value (%)			△
H010	Yarn length			△
H011	Center frequency (Hz)			△
H012	Output power			△
H013	Output torque (%)			△
H014	Target torque (%)			△
H015	Encoder phase sequence adjustment			△
H016	Reserved			△
H017	Current stage speed for multi-stage speed			△
H018	Input pulse frequency (0.01KHz)			△
H019	Feedback speed (Hz)			△
H020	Feedback speed (rpm)			△
H021	Monitoring AI1			△
H022	Monitoring AI2			△
H023	Monitoring AI3			△

H024	Reserved			△
H025	Power-On time (h)			△
H026	Running time (h)			△
H027	Input pulse frequency (Hz)			△
H028	Reserved			△
H029	Reserved			△
H030	Main frequency X (Hz)			△
H031	Accessorial frequency Y(Hz)			△
H032	Torque sent by master			△
H033	Frequency sent by master			△
H034	Quantity of slaves			△
H032- H040	Reserved			△

Note: × indicating that function code can only be modified in stop state.

√ indicating that function code can be modified both in stop and run state.

△ indicating that function code can only be checked in stop or run state but cannot be modified.

○ indicating that function code cannot be initialized as inverter restores manufacturer's value but can only be modified manually.

* indicating that function code can only be modified by manufacture.

Appendix 7 Encoder expansion card

I Model

Model	Function
EPG01	Differential PG card with frequency-division
EPG02	Non-differential PG card with frequency-division

II Specification

1) EPG01

	Function	Response speed	Output resistance	Voltage range	Output current	Frequency-division range
5V,CM	Power	---	About 300ohm	5V	300mA	---
A, AN B, BN	Differential encoder signal	0~80KHz	---	±5V	---	---
OUT-A,OUT-B	Frequency-division signal output	0~80KHz	About 30 ohm	---	100mA	1, 2~62 (even number)

2) EPG02

	Function	Response speed	Output resistance	Voltage range	Output current	Frequency-division range
+15V,CM	Power	---	About 300ohm	15±1.5V	300mA	---
PGA, PGB	Non-differential encoder signal	0~80KHz	---	0~15V	---	---
OUT-A, OUT-B	Frequency-division signal output	0~80KHz	About 30 ohm	---	100mA	1, 2~62 (even number)

III Dimension and installation

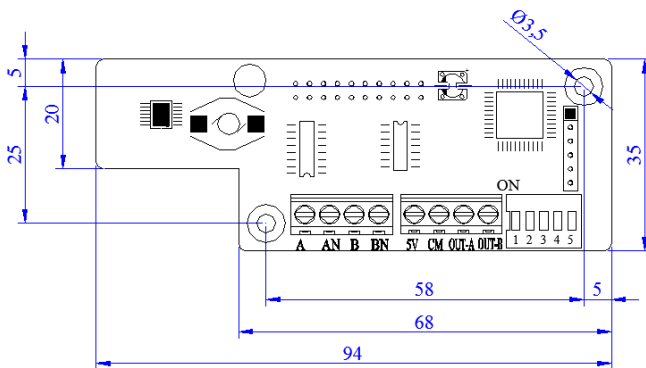

EPG01

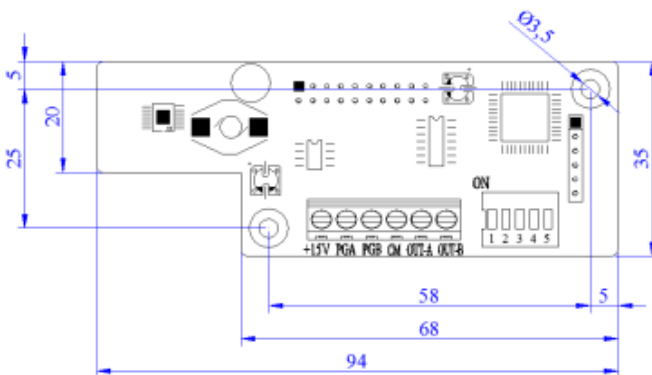

EPG02

For 5.5KW and above 5.5kW inverters, the expansion card is installed inside of inverter. The card is installed nearby control board, which is fastened by 3*5 self-tapping screw. J4 connector is connected to J10 in the control board by 20-core flat cable.

For blow 4.0kW inverters, PG card is installed outside of inverter, the cable should be shorter than 30cm.

IV Instruction

1. EPG01

1.1 Function

PG card must be selected when the drive is at the closed-loop vector control mode. PG card includes 2 orthogonal encoder signal process circuits, which can accept encoder signal of differential output, open-collector output, and push-pull output type. EPG01 is differential output PG card. The power of differential encoder is +5V. Besides, PG card can deal with encoder signal for frequency-division output (output is 2 orthogonal signal). User can select it according to actual situation.

1.2 Terminal and DIP

A	AN	B	BN	5V	CM	OUT-A	OUT-B
----------	-----------	----------	-----------	-----------	-----------	--------------	--------------

▪ A, AN, B and BN are differential encoder signal input terminals. 5V and GND are power and grounding of differential encoder. OUT-A、OUT-B + are frequency-division signal output terminals.

▪ The frequency-division coefficient is set by DIP switch on the PG card. DIP switch has 5-digit, binary numbers stand for coefficient. DIP 1 stands for low byte of binary, DIP 5 stands for high byte of binary. When the switch is turned to ON, it means “1” or else, it means “0”.

Please refer to below table:

	Binary	Frequency-division coefficient
0	00000	1
1	00001	2
2	00010	4
...
N	...	2N
31	11111	62

1.3 Diagram

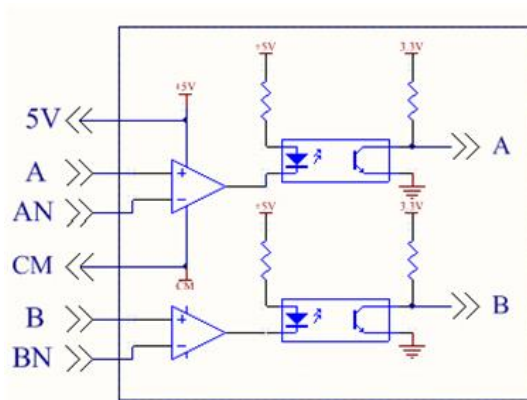

1.4 Frequency-division diagram

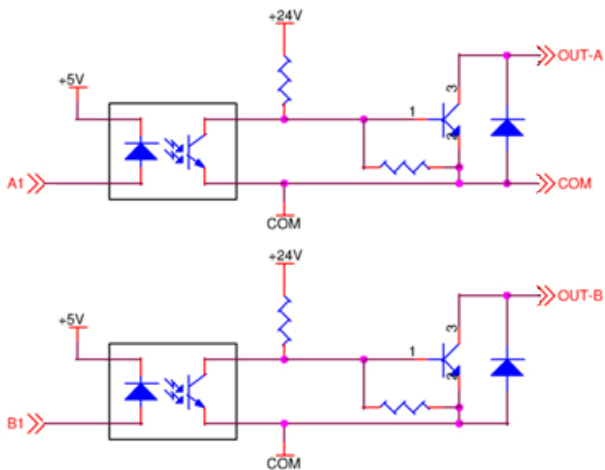

1.5 Caution

1. The signal wire of encoder should be far away from power wire.
2. Please select shielding wire as the encoder signal wire, and one end of it should be connected to grounding.
3. The given direction of inverter, the rotation direction of motor (from output axis of motor) and the rotation direction of encoder should be the same.

1.6 Connection

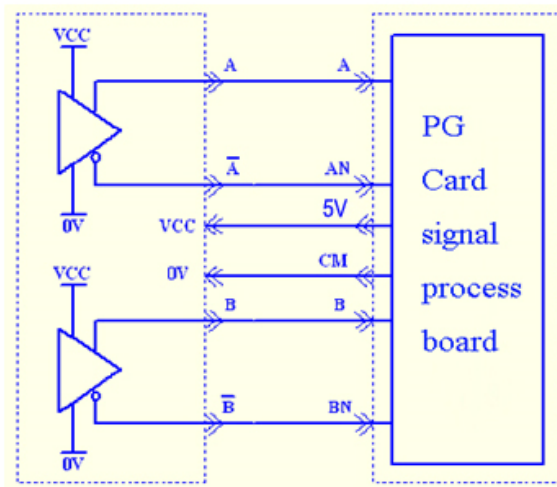

Differential output encoder (VCC=5V, please indicate it when differential encoder is selected).

2. EPG02

2.1 Function

PG card must be selected when the drive is at the closed-loop vector control mode. PG card includes 2 orthogonal encoder signal process circuits, which can accept encoder signal of differential output, open-collector output, and push-pull output type. EPG02 is non-differential output PG card. The power of differential encoder is +15V. Besides, PG card can deal with encoder signal for frequency-division output (output is 2 orthogonal signal). User can select it according to actual situation.

2.2 Terminal and DIP

+15V	PGA	PGB	CM	OUT-A	OUT-B
------	-----	-----	----	-------	-------

- OUT-A and OUT-B are frequency-division signal output terminals. PGA and PGB are non-differential encoder signal input terminals. +15V and CM are power and grounding of non-differential encoder.
 - The frequency-division coefficient is set by DIP switch on the PG card. DIP switch has 5-digit, binary numbers stand for coefficient. DIP 1 stands for low byte of binary, DIP 5 stands for high byte of binary. When the switch is turned to ON, it means "1" or else, it means "0".

Please refer to below table:

	Binary	Frequency-division coefficient
0	00000	1

1	00001	2
2	00010	4
...
N	...	2N
31	11111	62

2.3 Diagram

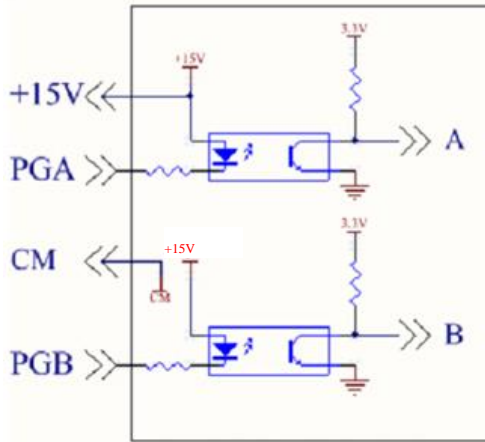

2.4 Frequency-division diagram

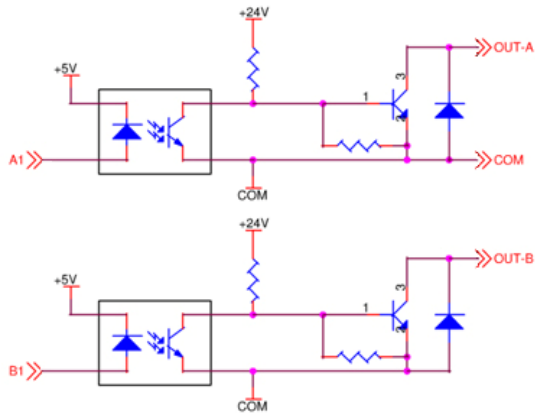

2.5 Caution

1. The signal wire of encoder should be far away from power wire.
2. Please select shielding wire as the encoder signal wire, and one end of it should be connected to grounding.
3. The length of shielding wire should be shorter than 30m, if user needs the wire longer than 30m, please indicate it.
4. The given direction of inverter, the rotation direction of motor (from output axis of motor) and the rotation direction of encoder should be the same.

II. Connection

3.1 Open-collector output encoder

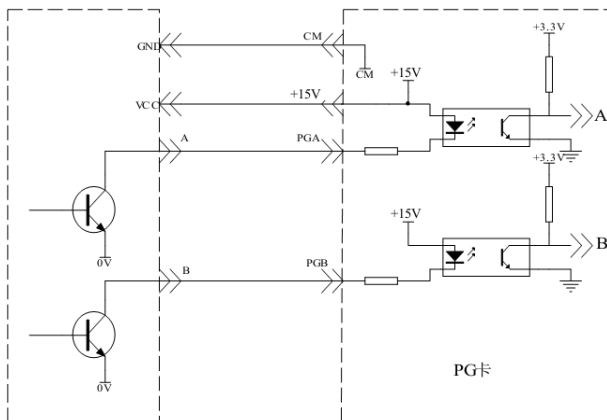

3.2 Push-Pull output encoder

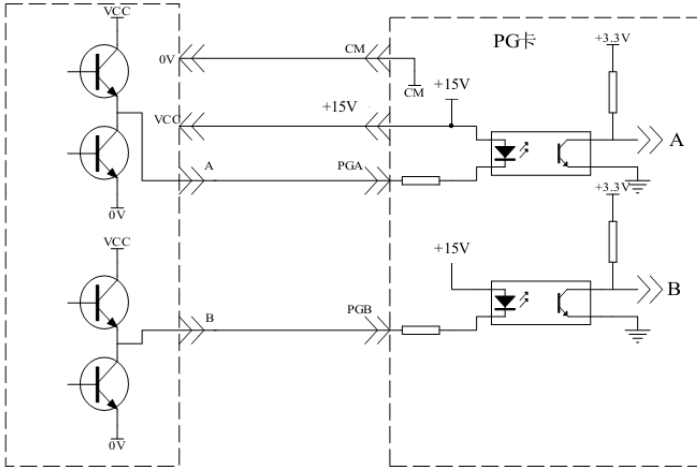

Appendix 8 Master/slave control

I. Overview

Master/slave control means several drives to control same system, which motor shafts are connected together with gear, chain, or conveyor. The load is averagely distributed among all drives. Master is controlled by external signal, master communicates with slaves by cables.

The link types between motors include rigid connection and flexible connection.

Rigid connection means motors are connected by gear, chain or nearer synchronous belt. The speed difference between master and slave is small, master control mode is speed control, slave control mode is torque control.

Flexible connection means motors are connected by conveyor, the speed of master and slave has a tiny difference, master control mode is speed control, and slave control mode is also speed control.

II. signal connection

1. CAN communication is adopted.
2. CAN communication distance

F926	6	5	4	3	2	1	0
Baud rate (kbps)	1000	500	250	125	100	50	20
Communication distance	40	130	270	530	620	1300	3300

(m)							
-----	--	--	--	--	--	--	--

The distance is measured value in the experiment, it has some difference with actual communication distance. User should adjust the distance according to actual situation, and shielding cable is suggested to be used.

- Control cables are connected to master, master is connected to slave by communication cable.

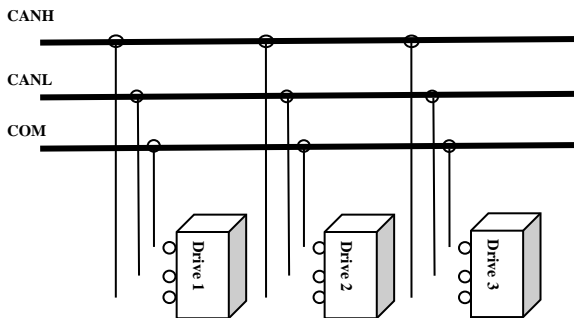

- When the application is load sharing, motors with same pole pairs and same rated frequency should be selected.

III. System debugging

Please make sure all cables are connected correctly. Set motor parameters, test control loop and motor running when inverter runs at low frequency in V/F control mode.

Check motor running direction. Each motor should run separately in V/F control mode, all motor running directions should be same, if the running direction is different, please change any two phases of motor.

Before setting master/slave control mode, please study each motor parameters separately.

IV. Parameters setting

- Rigid connection

Master: speed mode

Function code	Definition	Setting range	Setting value	Remarks
F106	Control mode	0:Sensorless vector control (SVC); 1: Closed-loop vector control (VC); 2: V/F; 3: Vector control 1	0	Must be
F111	Max Frequency (Hz)	F113~590.00	50.00	Same for master/salve

F200	Source of start command	0: Keypad command; 1: Terminal command; 2: Keypad+Terminal; 3:MODBUS; 4: Keypad+Terminal+MODBUS	4	
F201	Source of stop command	0: Keypad command; 1: Terminal command; 2: Keypad+Terminal; 3:MODBUS; 4: Keypad+Terminal+MODBUS	4	Must be
F209	Selecting the mode of stopping the motor	0: stop by deceleration time; 1: free stop 2: Stop by DC braking	1	
F911	Point-point communication selection	0:Disabled 1:Enabled	1	Must be
F912	Master and slave selection	0:Master 1:Slave	0	Must be
F915	Slave action when master stops	1: Free stop 2: Deceleration to stop	1	
F917	Slave following master command selection	0: given torque(torque) 1: given frequency 1(Droop) 2: given frequency 2 (Droop)	0	Must be
F926	CAN baud rate (kbps)	0:20 1:50 2:100 3:125 4: 250 5:500 6:1000	6	Same for master/salve

Slave: torque mode

Function code	Definition	Setting range	Setting value	Remarks
F106	Control mode	0:Sensorless vector control (SVC); 1: Closed-loop vector control (VC); 2: V/F; 3: Vector control 1	0	Must be
F111	Max Frequency (Hz)	F113~590.00	50.00	Same for master/salve
F200	Source of start command	0: Keypad command; 1: Terminal command; 2: Keypad+Terminal; 3:MODBUS; 4: Keypad+Terminal+MODBUS	4	Must be
F201	Source of stop	0: Keypad command;	4	Must be

	command	1: Terminal command; 2: Keypad+Terminal; 3:MODBUS; 4: Keypad+Terminal+MODBUS		
F203	Main frequency source	10: modbus	10	Must be
F209	Selecting the mode of stopping the motor	0: stop by deceleration time; 1: free stop 2: Stop by DC braking	1	
F911	Point-point communication selection	0:Disabled 1:Enabled	1	Must be
F912	Master and slave selection	0:Master 1:Slave	1	Must be
F913	Running command of slave	0:Slave not following running commands of master 1:Slave following running commands of master	1	Must be
F914	Fault information of slave	Ones: slave fault information 0: Not sending fault information 1: Sending fault information Tens: master's reaction when it loses slave's response 0: No reaction 1: Alarm	01	Must be
F916	Slave action when master stops	1: Free stop 2: Deceleration to stop	1	Must be
F917	Slave following master command selection	0: given torque(torque) 1: given frequency 1(Droop) 2: given frequency 2 (Droop)	0	Must be
F922	window	0.00~10.00	0.50	
FC00	Speed/torque control selection	0: Speed control 1: Torque control 2: Terminal switchover	1	Must be
FC06	Torque channel given	0: Digital given (FC09) 1: Analog input AI1 2: Analog input AI2 3: Analog input AI3 4: Pulse input channel FI 5: Reserved	5	Must be
F926	CAN baud rate (kbps)	0:20 1:50 2:100 3:125 4: 250 5:500 6:1000	6	Same for master/salve

2. flexible connection

Master: speed mode

Function code	Definition	Setting range	Setting value	Remarks
F111	Max Frequency (Hz)	F113~590.00	50.00	Same for master/salve
F200	Source of start command	0: Keypad command; 1: Terminal command; 2: Keypad+Terminal; 3:MODBUS; 4: Keypad + Terminal + MODBUS	4	Must be
F201	Source of stop command	0: Keypad command; 1: Terminal command; 2: Keypad+Terminal; 3:MODBUS; 4: Keypad + Terminal + MODBUS	4	Must be
F209	Selecting the mode of stopping the motor	0: stop by deceleration time; 1: free stop 2: Stop by DC braking	1	
F911	Point-point communication selection	0:Disabled 1:Enabled	1	Must be
F912	Master and slave selection	0:Master 1:Slave	0	Must be
F915	Slave action when master stops	1: Free stop 2: Deceleration to stop	1	
F917	Slave following master command selection	0: given torque(torque) 1: given frequency 1(Droop) 2: given frequency 2 (Droop)	1	Must be
F926	CAN baud rate (kbps)	0:20 1:50 2:100 3:125 4: 250 5:500 6:1000	6	Same for master/salve

Slave: speed mode

Function code	Definition	Setting range	Setting value	Remarks
F111	Max Frequency (Hz)	F113~590.00	50.00	Same for master/salve
F200	Source of start command	0: Keypad command; 1: Terminal command; 2: Keypad+Terminal; 3:MODBUS; 4: Keypad + Terminal +	4	Must be

		MODBUS		
F201	Source of stop command	0: Keypad command; 1: Terminal command; 2: Keypad+Terminal; 3:MODBUS; 4: Keypad + Terminal + MODBUS	4	Must be
F203	Main frequency source	10: modbus	10	Must be
F209	Selecting the mode of stopping the motor	0: stop by deceleration time; 1: free stop 2: Stop by DC braking	1	
F911	Point-point communication selection	0:Disabled 1:Enabled	1	Must be
F912	Master and slave selection	0:Master 1:Slave	1	Must be
F913	Running command of slave	0:Slave not following running commands of master 1:Slave following running commands of master	1	Must be
F914	Fault information of slave	Ones: slave fault information 0: Not sending fault information 1: Sending fault information Tens: master's reaction when it loses slave's response 0: No reaction 1: Alarm	01	Must be
F916	Slave following master command selection	0: given torque(torque) 1: given frequency 1(Droop) 2: given frequency 2 (Droop)	1	Must be
F917	Slave following master command selection	0: given torque(torque) 1: given frequency 1(Droop) 2: given frequency 2 (Droop)	1	Must be
F923	Droop control	0.0 (Invalid) 0.1~30.0	0.0	
F926	CAN baud rate (kbps)	0:20 1:50 2:100 3:125 4: 250 5:500	6	Same for master/salve

		6:1000		
--	--	--------	--	--

Note: user must set the parameters according to the table when the parameters' remarks are "must be".

V. Remarks

1. If baud rate must be decreased because of equipment distance, the time interval of master sending command must be extended.
2. The rated frequency of master and slave must be same.
3. The control mode (F106) of master and slave must be same.
4. Direction of master and slave must be same.
5. When rigid connection and in torque control, if slave cannot start because of low torque, torque bias should be increased.
6. Transfer boards are needed when master communicates with several slaves, please contact with manufacture.

Appendix 9 Input filter model and dimension

1. Input filter model			
Inverter model	Filter mode	Remarks	
E2000-0004S2	FN2060-6-06	1-phase plastic housing	
E2000-0007S2	FN2060-10-06		
E2000-0015S2	FN2060-20-06		
E2000-0022S2	FN2060-20-06		
E2000-0002T2	FN3258-7-44	3-phase 220V plastic housing	
E2000-0004T2	FN3258-7-44		
E2000-0007T2	FN3258-7-44		
E2000-0015T2	FN3258-16-44		
E2000-0022T2	FN3258-16-44		
E2000-0030T2	FN3258-16-44		
E2000-0040T2	FN3258-42-33		
E2000-0055T2	FN3258-42-33		
E2000-0075T2	FN3258-42-33		
E2000-0110T2	FN3258-55-34		
E2000-0150T2	FN3258-55-34		
E2000-0185T2	FN3258-100-35		
E2000-0220T2	FN3258-100-35		
E2000-0300T2	FN3359-180-28		3-phase 220V metal housing
E2000-0370T2	FN3359-180-28		
E2000-0450T2	FN3359-180-28		
E2000-0550T2	FN3359-250-28		
E2000-0750T2	FN3359-320-28		
E2000-0007T3	FN3258-7-44	3-phase 380V plastic housing	
E2000-0015T3	FN3258-7-44		
E2000-0022T3	FN3258-16-44		
E2000-0030T3	FN3258-16-44		
E2000-0040T3	FN3258-16-44		

E2000-0055T3	FN3258-16-44	3-phase 380V metal housing
E2000-0075T3	FN3258-42-33	
E2000-0110T3	FN3258-42-33	
E2000-0150T3	FN3258-42-33	
E2000-0185T3	FN3258-55-34	
E2000-0220T3	FN3258-55-34	
E2000-0300T3	FN3258-75-34	
E2000-0370T3	FN3258-100-35	
E2000-0450T3	FN3258-100-35	
E2000-0550T3	FN3359-180-28	
E2000-0750T3	FN3359-180-28	
E2000-0900T3	FN3359-250-28	
E2000-1100T3	FN3359-250-28	
E2000-1320T3	FN3359-320-28	
E2000-1600T3	FN3359-400-99	
E2000-1800T3	FN3359-400-99	

2. Dimension

1) FN2060 dimension and installation

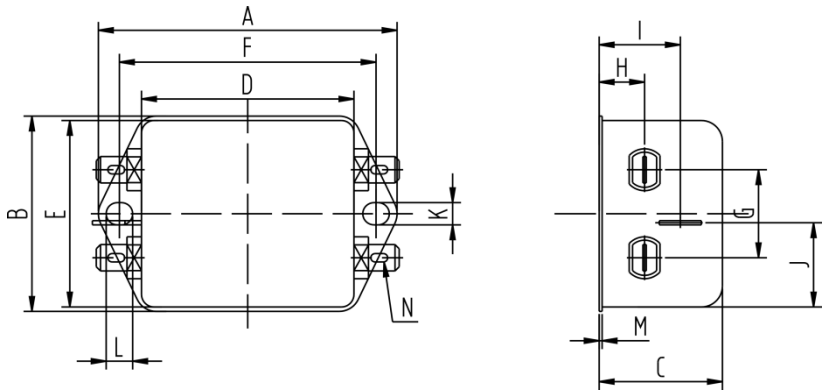

Model	FN2060-6-06	FN2060-10-06	FN2060-20-06
A	71	85	113.5±1
B	46.6	54	57.5±1
C	29.3	30.3	45.4±1
D	50.5	64.8	94±1
E	44.5	49.8	56
F	61	75	103
G	21	27	25
H	10.8	12.3	12.4
I	19.3	20.8	32.4
J	20.1	19.9	15.5
K	5.3	5.3	4.4
L	6.3	6.3	6
M	0.7	0.7	0.9
N	6.3×0.8		

2) FN3258 dimension and installation

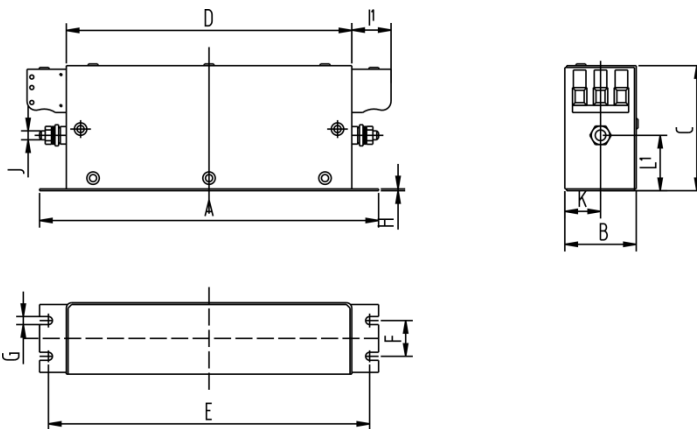

Model	FN3258-7 -44	FN3258-16 -44	FN3258-42 -33	FN3258-55 -34	FN3258-75 -34	FN3258-100 -35
A	190	250	310	250	270	270
B	40	45	50	85	80	90
C	70	70	85	90	135	150
D	160	220	280	220	240	240
E	180	235	295	235	255	255
F	20	25	30	60	60	65
G	4.5	5.4	5.4	5.4	6.5	6.5
H	1	1	1	1	1.5	1.5
II	22	22	25	39	39	45
J	M5	M5	M6	M6	M6	M10
K	20	22.5	25	42.5	40	45
L1	29.5	29.5	37.5	26.5	70.5	64

3) FN3359 dimension and installation

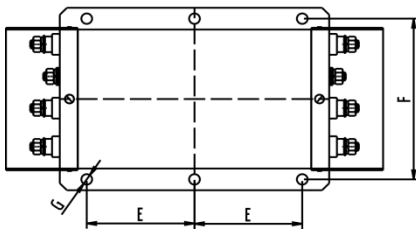
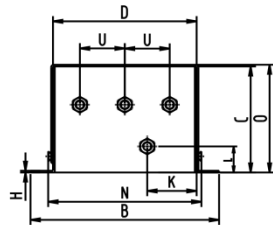
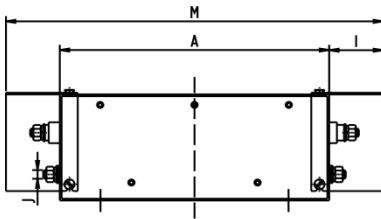

Model	FN3359-180-28	FN3359-250-28
A	300	300
B	210	230
C	120	125
D	160	180
E	120	120
F	185	205
G	φ12	φ12
H	2	2
I	33	33
J	M10	M10
K	55	62.5
L	30	35
M	420	420
N	171	191
O	127	132
U	50	55

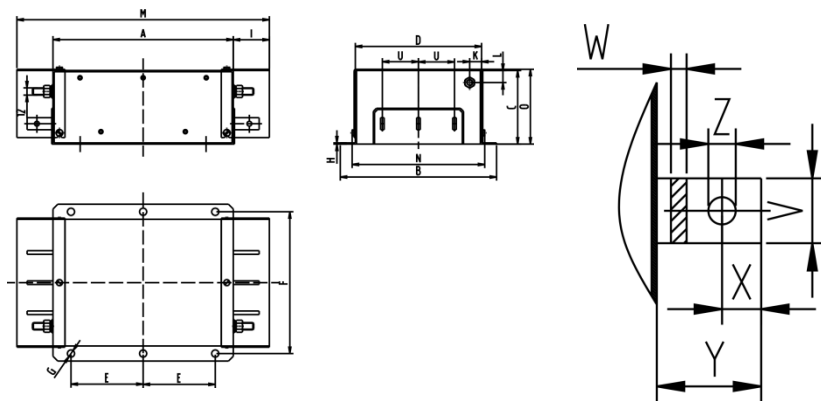

Model	FN3359-320-28	FN3359-400-99
A	300	300
B	260	260
C	115	115
D	210	210
E	120	120
F	235	235
G	φ12	φ12
H	2	2
I	43	43
J	M12	M12
K	20	20
L	20	20
M	440	440
N	221	221
O	122	122
U	60	60
V	25	25
W	6	6
X	15	15
Y	40	40
Z	φ10.5	φ10.5

Note:

1. E2000 series inverter without built-in filter satisfies the CE requirements only with an EMC filter installed on the power input side.
2. When frequency inverter model does not include R3, the customer should select above options. There is no external filter for 200kw and above 200kw AC drive; they can satisfies the CE requirements.

Appendix 10 Bus communication

I. EtherCAT

1.1 Introduction

EtherCAT is a real-time Industrial Ethernet technology with the feature of flexible topology and easy operation. The protocol is suitable for high-speed control field because of its fast communication speed and efficient transmission rate of available data. With the CoE protocol, EtherCAT provides the same communication mechanisms as in CANopen: object dictionary, PDO, SDO and even the network management is similar. This makes it possible to implement EtherCAT with minimal effort in devices that were previously outfitted with CANopen, and large portions of the CANopen Firmware are even reusable.

1.2 Installation and connection

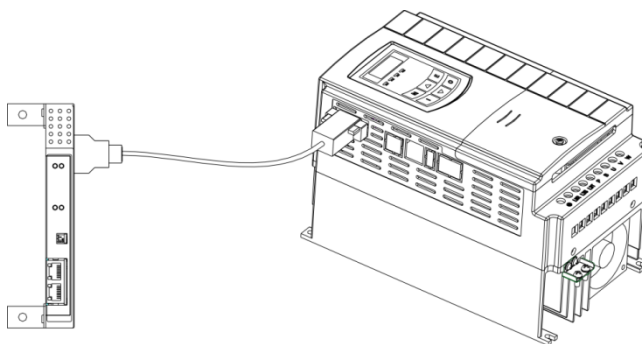

Fig1 Ether-CAT card installation

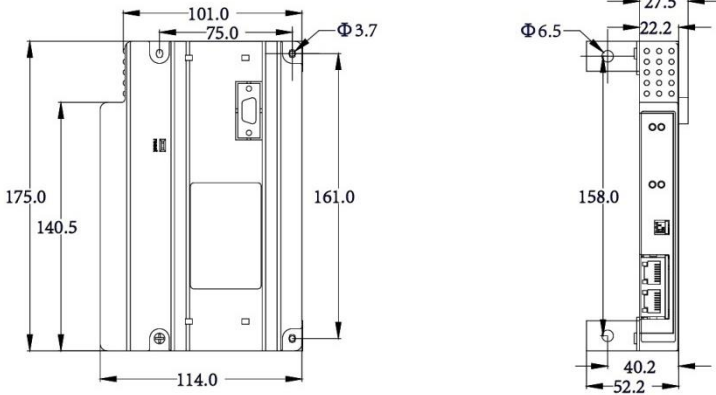

Fig2 Ether-CAT card dimension

1.3 Hardware layout

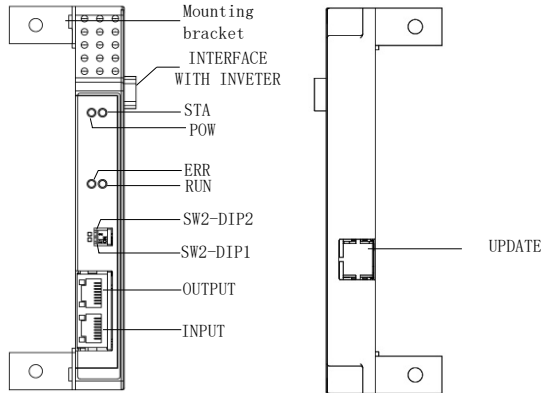

Fig 3 EtherCAT bus card

1.4 Topology

Line, tree, or star-chain: EtherCAT supports almost all of topologies. EtherCAT makes a pure bus or line topology with hundreds of nodes possible without the limitations that normally arise from

cascading switches or hubs.

When wiring the system, the combination of lines with branches or drop lines is beneficial: the ports necessary to create branches are directly integrated in many I/O modules, so no additional switches or active infrastructure components are required.

Additional flexibility is given regarding the possible cable types. Inexpensive industrial Ethernet cable can be used between two nodes up to 100m apart in 100BASE-TX mode.

Up to 65,535 devices can be connected to EtherCAT, so network expansion is virtually unlimited. As is usual with Ethernet, arbitrary changes between the physical layers are allowed.

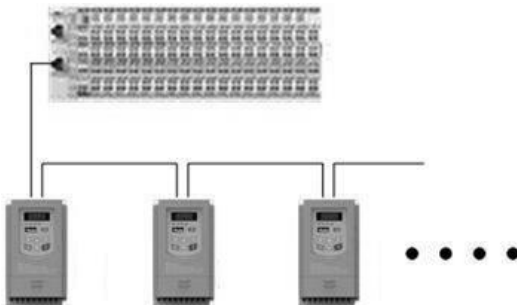

1.5 LED indicator

Led number	Color	Function
STA	Green	STATUS
POW	Green	Power_on
RUN	Green	FieldBus_Run
ERR	Red	FieldBus_Error

1.6 Switch2

SW2-dip1	ON	Download program
	OFF	Running program
SW2-dip2	ON	Connect with terminal resistance.
	OFF	Disconnect with terminal resistance.

II. CANopen

2.1 CANopen is a high layer protocol which bases on CAN serial bus system and CAL(CAN application layer). The communication card is used to connect inverter to CAN network.

2.2 Installation

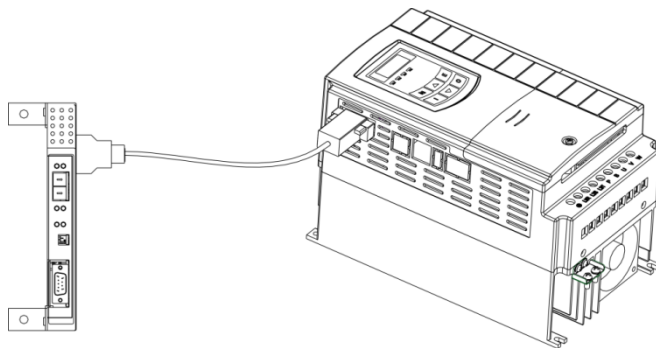

Fig 9-5 CANopen card installation

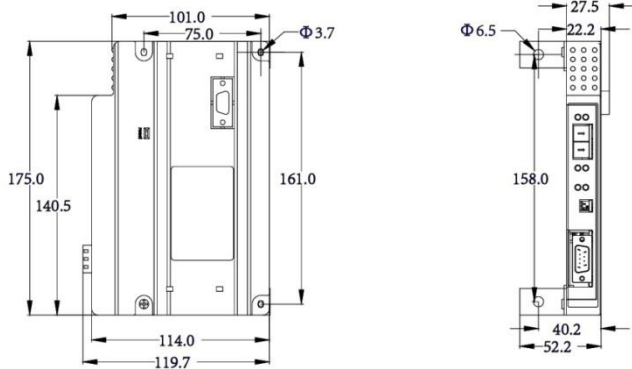

Fig 9-6 CANopen card dimension

2.3 DB15 interface pins

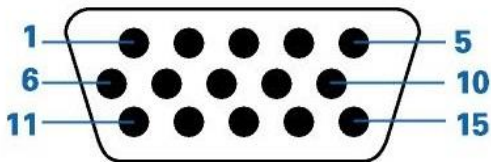
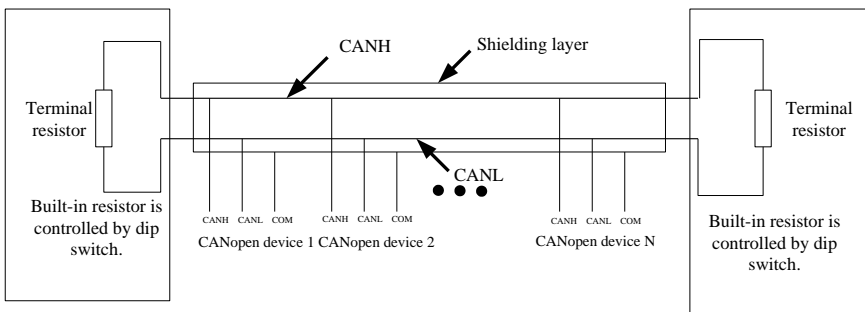

Fig 9-7 interface pins

Pins No.	Signal cable
1, 6	GND
2,7	AA
3,8	BB
4,9	LL
5,10	24V
11,12	YY
13	M0_IN
14,15	RES_IN

2.4 CAN-bus connection



2.5 Hardware layout

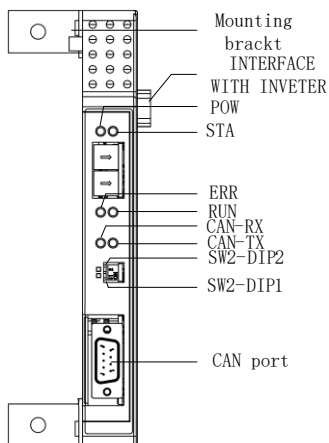

2.6 LED indicator

Led number	Color	Function
STA	Green	STATUS
POW	Green	Power_on
RUN	Green	FieldBus_Run
ERR	Red	FieldBus_Error
RX	Green	CAN_RX
TX	Red	CAN_TX

2.7 Switch code

Switch code	Position	Instructions
SW1-dip1	ON	Drives select 485 mode.
	OFF	Drives select 422 mode.
SW1-dip2	ON	Connect with terminal resistance.
	OFF	Disconnect with terminal resistance.
SW2-dip1	ON	Download program
	OFF	Download succeeds.
SW2-dip2	ON	Connect with terminal resistance of CAN network.
	OFF	Disconnect with terminal resistance of CAN network.

III Profibus**3.1 Introduction**

PROFIBUS is a vendor independent, open fieldbus standard for a wide range of applications in manufacturing, process and building automation. Vendor independence and openness are guaranteed by the PROFIBUS standard EN50170. With PROFIBUS, devices from different manufacturers can inter-communicate. Suitable interfaces exist for PLCs, which include the Siemens, Mitsubishi and Allen Bradley range.

PROFIBUS-DP (De-central Periphery) is described in DIN 19245 Part 3, and forms part of EN 50170 with P-Net and WorldFIP. However it is important to note that P-Net and WorldFIP are wholly incompatible with PROFIBUS, using different wiring and transmission technologies.

The PROFIBUS-DP network uses a high speed version of the RS485 standard, permitting baud rates of up to 12Mbaud.

A maximum of 32 PROFIBUS-DP stations (nodes) may be contained within a single network segment. Use of RS485 repeaters allows a total of up to 126 stations.

PROFIBUS-DP is a multimaster, master-slave, token passing network. More detailed information, including a detailed guide to products available, may be obtained from the various world-wide PROFIBUS user organisations.

3.2 Installation and connection

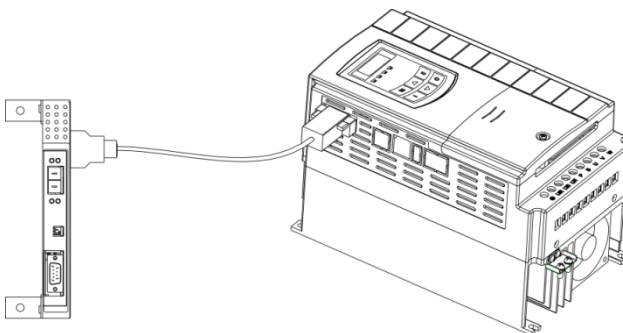

Fig 9-11 connection between communication card and inverter

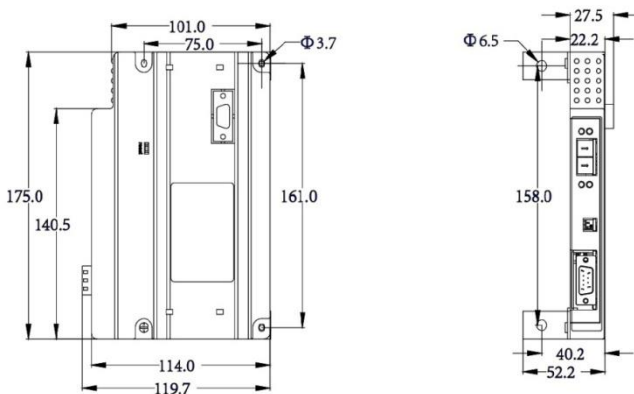
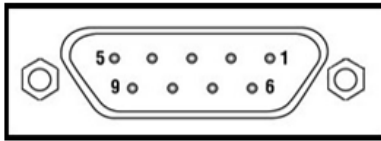

Fig 9-12 Communication card dimension

3.2 Pins definition



Pins No.	Definition	Function
1	--	N/C
2	--	N/C
3	RX/TX-P	Receive/transmit data P (B-Line)
4	RTS	Connect to relay station
5	GND	Grounding of 5V power
6	5V	5V power
7	--	N/C
8	RX/TX-N	Receive/transmit data N (A-Line)
9	--	N/C

3.4 Hardware layout

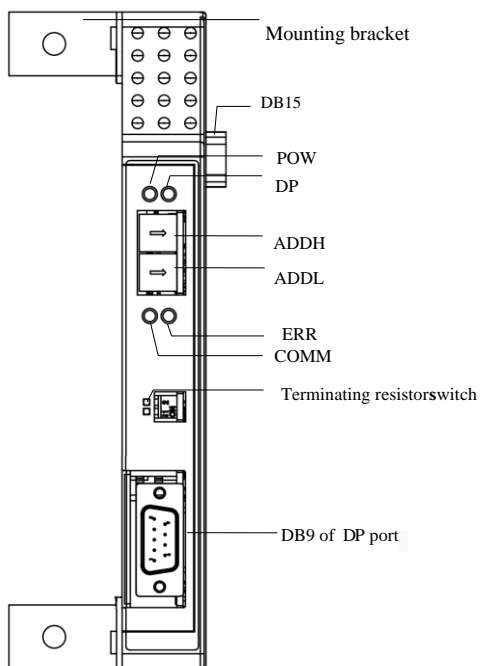

Fig 2-2 Communication card appearance and structure component

3.5 LED display

LED status	POW	DP	COMM	ERR
ON	Power on	DP enters into data interaction state.	Communication succeeds.	Slave address sets wrongly or drive trips into fault status.
1Hz FLASH	-	-	-	The function code parameter address of card access inverter is illegal.
2Hz FLASH	-	-	Communication card is searching inverter.	The function code parameter data of card

				access inverter is illegal.
OFF	Power failure	DP does not enter into data interaction state.	-	The access is correct.

Note: 1. 1-phase 0.4~0.75kw drives do not support Ethercat, Profibus and CANopen communication.

3. please refer to user manual of bus communication or Contact with manufacture.

IV BACnet

The related parameters are as below:

Parameter	Function description	Setting value	Mfr's value
F928	BACnet address	0~127	1
F929	BACnet baud rate(bps)	0: 9600 1:19200 2: 38400 3:76800	1
F933	BACnet device number	0~65535	1

2019112211B