

CONTENTS

I. Product	1
1.1 Product model naming rule.....	1
1.2 Optional function naming rule.....	1
1.3 Nameplate.....	3
1.4 Appearance.....	3
1.5 Technical Specifications	6
1.6 Designed Standards for Implementation.....	8
1.7 Safe Instructions.....	8
1.8 Precautions.....	9
1.9 Examination and Maintenance.....	8
II. Keypad panel.....	12
2.1 Panel Illustrations.....	12
2.2 Panel Structure.....	13
2.3 Panel Operating	15
2.4 Parameters Setting	15
2.5 Function Codes Switchover In/Between Code-Groups.....	16
2.6 Panel Display	17
III. Installation & Connection	18
3.1 Installation.....	18
3.2 Connection	18
3.3 Measurement of main circuit voltage, current and power.....	19
3.4 Function of Control Terminals.....	22
3.5 Wiring Recommended.....	25
3.6 Lead Section Area of Protect Conductor(grounding wire)	25
3.7 Overall Connection.....	26
3.8 Basic methods of suppressing the noise.....	27
IV. Operation and Simple Running	32
V. Function Parameters	40

5.1	Basic Parameters.....	40
5.2	Operation Control	48
5.3	Multifunctional Input and Output Terminals.....	55
5.4	Analog Input and Output.....	62
5.5	Multi-stage Speed Control.....	67
5.6	Auxiliary Functions.....	70
5.7	Malfunction and Protection.....	74
5.8	Parameters of the motor.....	78
5.9	Communication parameters.....	82
5.10	PID parameters.....	83
5.11	Torque control parameters.....	87
Appendix 1	Trouble Shooting.....	89
Appendix 2	Products and Structure	92
Appendix 3	Selection of Braking Resistance	95
Appendix 4	Communication Manual.....	96
Appendix 5	Reference wiring of water system.....	106
Appendix 6	Zoom Table of Function Code	109
Appendix 7	Input filter model and dimension.....	127

I. Product

This manual offers a brief introduction of the installation connection for E800 series inverters, parameters setting and operations, and should therefore be properly kept. Please contact manufacturer or dealer in case of any malfunction during application.

1.1 Product model naming rule

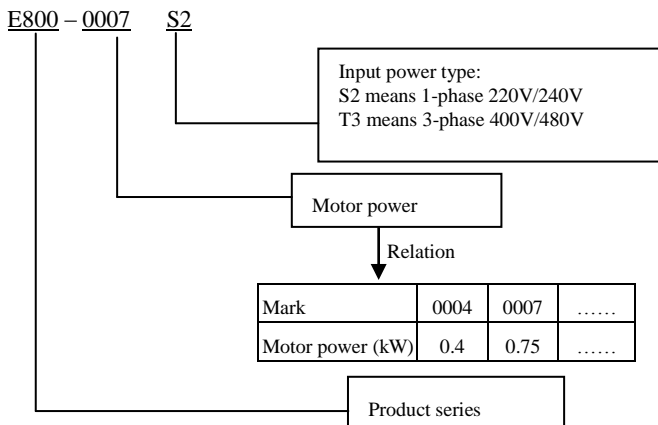

1.2 function naming rule

C5 U5 F2 AF03 B1 R3 L1

Choke	L1	DC choke	Remarks 1
Filter	R3	C3 level filter	Remarks 2
Braking type	B1	Dynamic braking	Remarks 3
Keypad	AF03	AF English no potentiometer LED keypad	Remarks 4
Communication	F2	Modbus is connected by terminal	Remarks 5
Certificate	U5	UL+CE	Remarks 6
Structure code	C5	C5 structure	

Remarks:

1. DC choke is optional for 55kw and above 55kw.
2. Filter is optional and built-in for 45kw and below 45kw.
3. Braking unit is standard for 3-phase 400V 30kw and below 30kw, and braking unit is built-in and optional for 1-phase 220V, 3 phase 220V inverters 1.5kW, 2.2kW and 3-phase 37kW-132kW. 160kW and above 160kW inverters have no built-in braking unit.

4. Local keypad :

Structure code	Keypad code	Contents
E1	AE01	AE Chinese version without potentiometer
	AE02	AE Chinese version with potentiometer
	AE03	AE English version without potentiometer
	AE04	AE English version with potentiometer
E2~E6	AF01	AF Chinese version without potentiometer
	AF02	AF Chinese version with potentiometer
	AF03	AF English version without potentiometer
	AF04	AF English version with potentiometer
E7~CB	A601	A6 Chinese version without potentiometer
	A602	A6 Chinese version with potentiometer
	A603	A6 English version without potentiometer
	A604	A6 English version with potentiometer

Remote keypad model:

Keypad	
A601	A6 Chinese LED without potentiometer
A602	A6 Chinese LED with potentiometer
A603	A6 English LED without potentiometer
A604	A6 English LED with potentiometer
A612	A6 Chinese LED with digital potentiometer
A614	A6 English LED with digital potentiometer
AA01	AA Chinese LED without potentiometer
AA02	AA Chinese LED with potentiometer
AA03	AA English LED without potentiometer
AA04	AA English LED with potentiometer
AA05	AA Chinese/English LED without potentiometer

5. Communication

Structure code	Communication code	Contents
E1	F2	Modbus

6. Certificate

Certificate code	Contents	Inverter power
U1	CE	≤450kW
U5	UL+CE	≤22kW

1.3 Nameplate

Taking for instance the E800 series 0.75 kW inverter with 1-phase input, its nameplate is illustrated as Fig 1-1.

EURA DRIVES ELECTRIC CO.,LTD			
MODEL	E800-0007S2	OPTION	E1U1F2AE02B1R3
INPUT	1PH AC	220 V	50/60Hz
OUTPUT	3PH AC	0~INPUT V	4.5A
0.75kW			
 IP20		Made in China	

1Ph: single-phase input; 220~240V, 50/60Hz: input voltage range and rated frequency.

3Ph: 3-phase output; 4.5A, 0.75 kW: rated output current and power;

0.50~590.0Hz: output frequency range.

1.4 Appearance

1.4.1 Appearance

The external structure of E800 series inverter is classified into plastic and metal housings. And wall Housing type is adopted. Good poly-carbon materials are adopted through die-stamping for plastic housing with nice form, good strength and toughness.

Taking E800-0110T3 for instance, the external appearance and structure are shown as in below Fig.

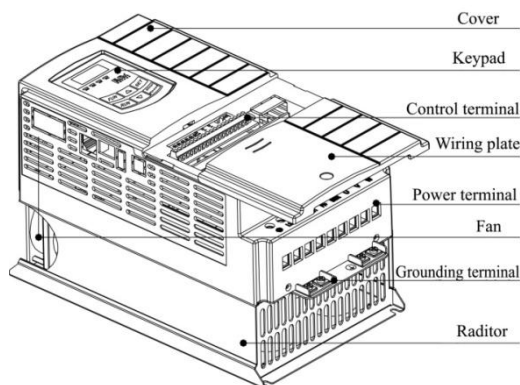

Metal housing uses advanced exterior plastic- spraying and powder-spraying process on the surface with elegant color and with detachable one-side door hinge structure adopted for front cover, convenient for wiring and maintenance. Taking E800-0550T3 for instance, its appearance and structure are shown as in right Fig.

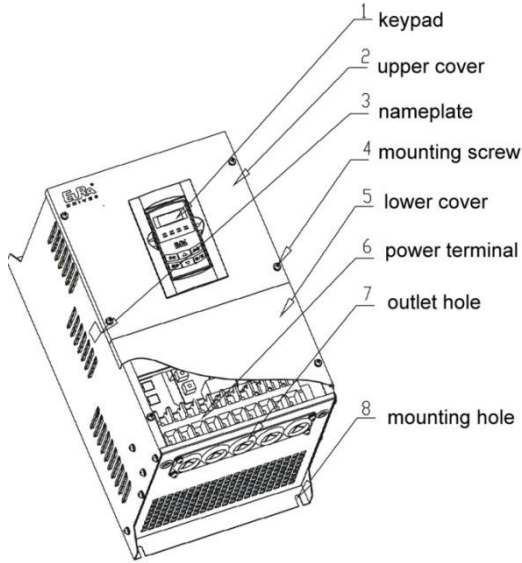

1.4.2 Interface
(1) E1 structure

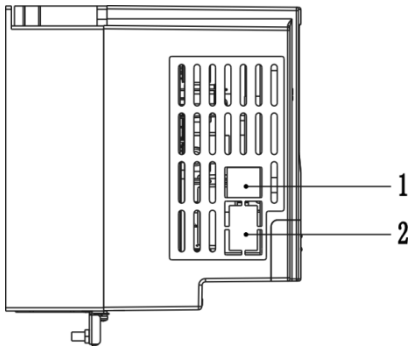

(2) E2-E6 structure

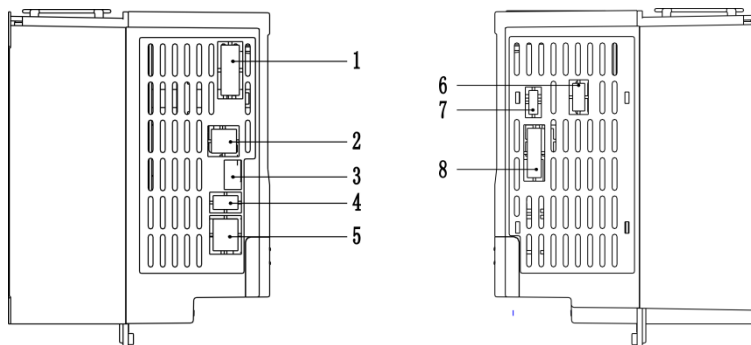

(3) E7-CB structure

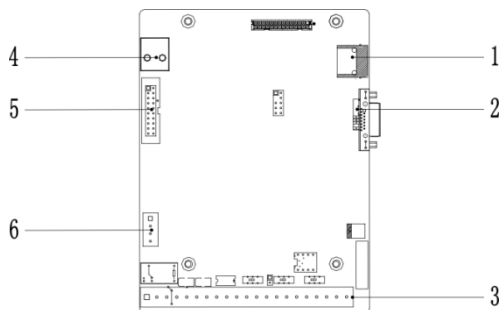

Table 1-1 E800 interface introduction

Structure No.	Contents		
	E1 structure	E2~E6 structure	E7 and Metal structure
1	8-core net cable remote keypad interface	Reserved	8-core net cable remote keypad interface
2	RS-485 communication (A+,B-)	8-core net cable remote keypad interface	Reserved
3		RS-485 communication (A+,B-)	Control terminal
4		Reserved	Reserved
5		Reserved	Reserved
6		Reserved	RS-485 communication (A+,B-)
7		Reserved	
8		Reserved	

1.5 Technical Specifications

Table1-1 Technical Specifications for E800 Series Inverters

	Items	Contents
Input	Rated Voltage Range	3-phase 380-480V (+10%, -15%) ^{note} 1-phase 220-240V \pm 5%
	Rated Frequency	50/60Hz
Output	Rated Voltage Range	3-phase 0-INPUT (V)
	Frequency Range	0.50~590.0Hz (In SVC control mode, the max frequency should be lower than 500Hz.)
Control Mode	Carrier Frequency	0.8~10kHz; Fixed carrier-wave and random carrier-wave is selected by F159.
	Input Frequency Resolution	Digital setting: 0.01Hz, analog setting: max frequency \times 0.1%
	Control Mode	VVVF control, SVC (open-loop vector control) control, For PMSM: SVC (open-loop vector control) control
	Start Torque	0.5Hz/150%
	Speed-control Scope	1: 100
	Steady Speed Precision	\pm 0.5%
	Torque Control Precision	\pm 5%
	Overload Capacity	120% rated current, 60 seconds.
	Torque Elevating	Auto torque promotion, Manual Torque Promotion includes 1-20 curves.
	V/F Curve	3 kinds of modes: beeline type, square type and under-defined VVVF curve.
	Startup mode	Start directly, speed tracing startup.
	DC Braking	DC braking frequency: 0.2-50.00 Hz, braking time: 0.00~30.00s
	Jogging Control	Jogging frequency range: min frequency~ max frequency, jogging acceleration/deceleration time: 0.1~3000.0s
	Auto Circulating Running and multi-stage speed running	Auto circulating running or terminals control can realize 15-stage speed running.
Built-in PID adjusting	Easy to realize a system for process closed-loop control	
Auto voltage regulation (AVR)	When source voltage changes, the modulation rate can be adjusted automatically, so that the output voltage is unchanged.	
Operation Function	Frequency Setting	Potentiometer or external analog signal (0~5V, 0~10V, 0~20mA); keypad (terminal)▲ / ▼ keys, external control logic and automatic circulation setting.
	Start/Stop Control	Terminal control, keypad control or communication control.
	Running Command Channels	3 kinds of channels from keypad panel, control terminal and MODBUS.
	Frequency Source	Frequency sources: given digit, given analog voltage, given analog current and given MODBUS.
	Accessorial frequency Source	5 kinds of accessorial frequency
Optional	Built-in EMI filter, built-in braking unit.	

Protection Function	Input phase loss, Output phase loss, input under-voltage, DC over-voltage, over-current, inverter over-load, motor over-load, current stall, over-heat, external disturbance, analog line disconnected.	
Display	LED nixie tube showing output frequency, rotate-speed (rpm), output current, output voltage, linear-velocity, types of faults, and parameters for the system and operation; LED indicators showing the working status of inverter.	
Environment Conditions	Equipment Location	In an indoor location, Prevent exposure from direct sunlight, Free from dust, tangy caustic gases, flammable gases, steam or the salt-contented, etc.
	Environment Temperature	-10℃~+40℃
	Environment Humidity	Below 90% (no water-bead coagulation)
	Vibration Strength	Below 0.5g (acceleration)
	Height above sea level	1000m or below (If the height is higher than 1000m, derating must be considered, please refer to Fig1-7).
Protection level	IP20	
Applicable Motor	0.2~450 kW	

Note 1: under different voltage level, user should connect jumper on the pin board for 160kw and above 160kw, the model of pin board is E2F3UZ00.

- 1) When input voltage is 380~420VAC, please connect CN2 to CN3 (380V Jumper).
- 2) When input voltage is 420~480VAC, please connect CN4 to CN5 (480V Jumper).

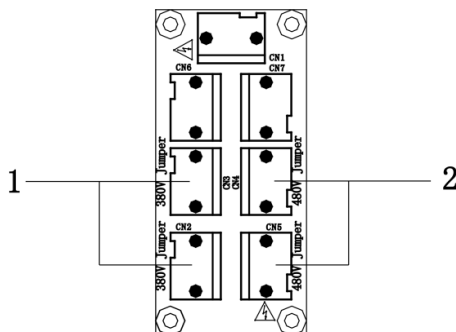

The default system is 380~420VAC, if some operation is needed, please power off inverter and contact with profession engineer.

1.6 Designed Standards for Implementation

- IEC/EN 61800-5-1: 2003 Adjustable speed electrical power drive systems safety requirements.
- IEC/EN 61800-3: 2004/ +A1: 2012 Adjustable speed electrical power drive systems-Part 3: EMC product standard including specific test methods.

1.7 Safe instructions

- Please check the model in the nameplate of the inverter and the rated value of the inverter. Please do not use the damaged inverter in transit.
- Installation and application environment should be free of rain, drips, steam, dust and oily dirt; without corrosive or flammable gases or liquids, metal particles or metal powder. Environment temperature within the scope of $-10^{\circ}\text{C}\sim+40^{\circ}\text{C}$.
- Please install inverter away from combustibles.
- Do not drop anything into the inverter.
- The reliability of inverters relies heavily on the temperature. The around temperature increases by 10°C , inverter life will be halved. Because of the wrong installation or fixing, the temperature of inverter will increase and inverter will be damaged.
- If inverter is installed in a control cabinet, smooth ventilation should be ensured and inverter should be installed vertically. If there are several inverters in one cabinet, in order to ensure ventilation, please install inverters side by side. If it is necessary to install several inverters up and down, please add heat-insulation plate.

Installing vertically

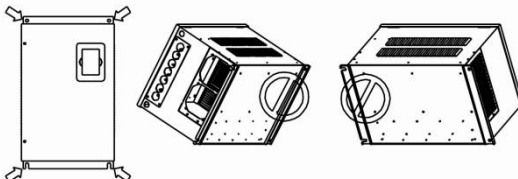

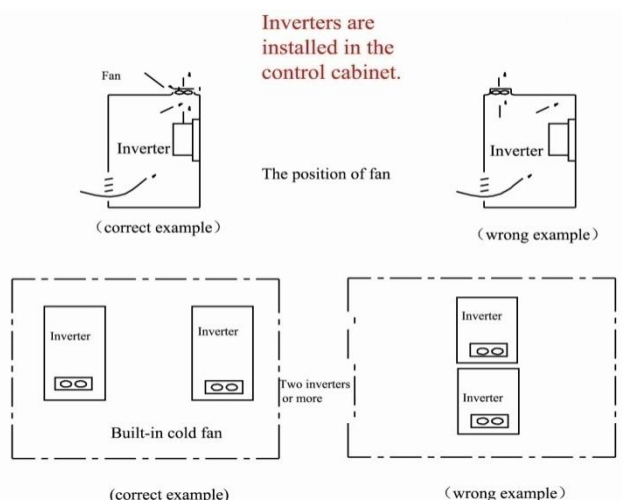

1.8 Precautions

1.8.1 Instructions for use

- Only qualified electricians are allowed to operate on the inverter.
- Do not carry out any wiring and inspection or changing components when the power supply is applied. Ensure all input power supply is disconnected before wiring and checking and always wait for at least the time designated on the inverter or until the DC bus voltage is less than 36V. Below is the table of the waiting time:

inverter model	Min theoretical waiting time
110kW and below 110kW	5 minutes
132kW – 315kW	30 minutes
Above 355kW	45 minutes

- Never touch the internal elements within 15 minutes after power off. Wait till it is completely discharged.
- Input terminals R, S and T are connected to power supply of 400V while output terminals U, V and W are connected to motor.
- Proper grounding should be ensured with grounding resistance not exceeding 4Ω; separate grounding is required for motor and inverter. Grounding with series connection is forbidden.
- There should be separate wiring between control loop and power loop to avoid

any possible interference.

- Signal line should not be too long to avoid any increase with common mode interference.
- If circuit breaker or contactor needs to be connected between the drive and the motor, be sure to operate these circuit breakers or contactor when the drive has no output, to avoid damaging of drive.
- Before using the drive, the insulation of the motors must be checked, especially, if it is used for the first time or if it has been stored for a long time. This is to reduce the risk of the drive from being damaged by the poor insulation of the motor.
- Do not connect any varistor or capacitor to the output terminals of the drive, because the drive's output voltage waveform is pulse wave, otherwise tripping or damaging of components may occur; in addition, do not install circuit breaker or contactor at the output side of the drive as shown in Fig 1-8.

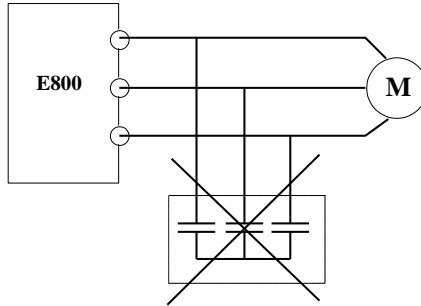

Fig 1-8 Capacitors are prohibited to be used.

- Derating must be considered when the drive is installed at high altitude, greater than 1000m. This is because the cooling effect of drive is deteriorated due to the thin air, as shown in Fig. 1-9 that indicates the relationship between the elevation and rated current of the drive.

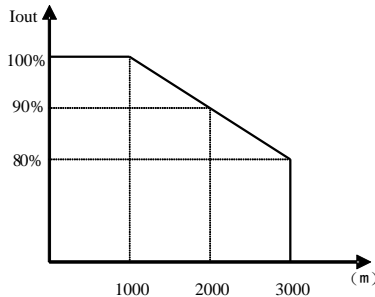



Fig 1-9 Derating drive's output current with altitude

1.8.2 Special Warning

- Never touch high-voltage terminals inside the inverter to avoid any electric shock.
- Before inverter is powered on, please be sure that input voltage is correct.
- Please do not connect input power supply onto U, V, W or  terminals.
- Please do not install inverter directly under sunshine, do not block up the cooling hole.
- All safety covers should be well fixed before inverter is power connected, to avoid any electric shock.
- Only professional personnel are allowed for any maintenance, checking or replacement of parts.
- No live-line work is allowed.

1.9 Maintenance

1.9.1 Periodic Checking

- Cooling fan and wind channel should be cleaned regularly to check whether it is normal; remove the dust accumulated in the inverter on a regular basis.
- Check inverter's input and output wiring and wiring terminals regularly and check if wirings are ageing.
- Check whether screws on each terminals are fastened.
- Check whether inverter is corrosive.

1.9.2 Storage

- Please put the inverter in the packing case of manufacture.
- If inverter is stored for long time, please charge the inverter within half a year to prevent the electrolytic capacitors damaged. The charging time should be longer than 5 hours.

1.9.3 Daily Maintenance

Environment temperature, humidity, dust and vibration would decrease the life of inverter. Daily maintenance is necessary to inverter.

Daily inspecting:

- Inspecting for noise of motor when it is working.
- Inspecting for abnormal vibration of motor when it is working.
- Inspecting for the installing environment of inverter.
- Inspecting for the fan and inverter temperature.

Daily cleaning:

- Keep the inverter clean. Clean surface dust of inverter to prevent dust, metal powder, oily dirt and water from dropping into the inverter. Inspecting for the fan and inverter temperature.

Daily cleaning:

Keep the inverter clean. Clean surface dust of inverter to prevent dust, metal powder, oily dirt and water from dropping into the inverter.

II. Keypad panel

Keypad panel and monitor screen are both fixed on keypad controller. Two kinds of controllers (with and without potentiometer) are available for E800 series inverters. Refer to note for Fig2-1.

2.1 Panel Illustration

The panel covers three sections: data display section, status indicating section and keypad operating section, as shown in Fig. 2-1.

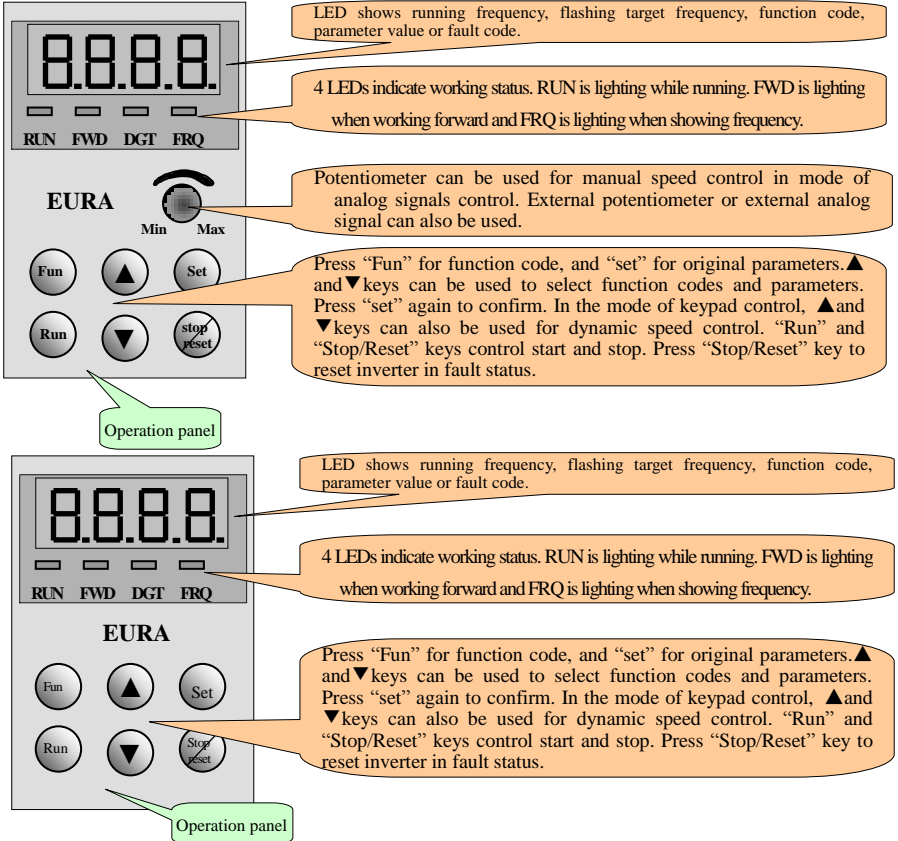

Fig.2-1 Operation Panels in Two Kinds

Instructions for operation panel:

1. Operation panels of below 30 kW can not be pulled out. Please select AA-A or A6-1-A control panel to realize remote control, which is connected by 8-core net cable.
2. Operation panels of above 37 kW can be pulled out, which is connected by 8 core net cable.

2.2 Panel structure

1. structure diagram

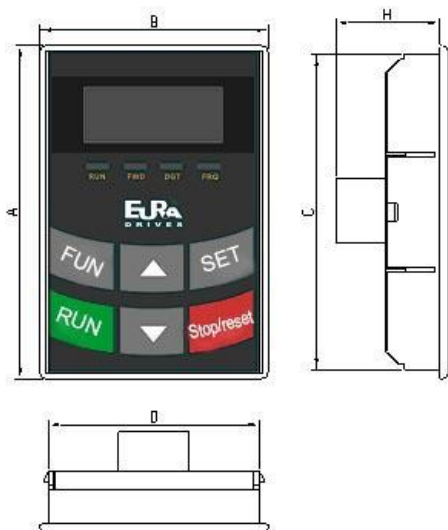

2. Structure size (Unit: mm)

Code	A	B	C	D	H	Opening size
AA	76	52	72	48	24	73*49
A6-1	124	74	120	70	26	121*71

3. Panel mounting structure diagram

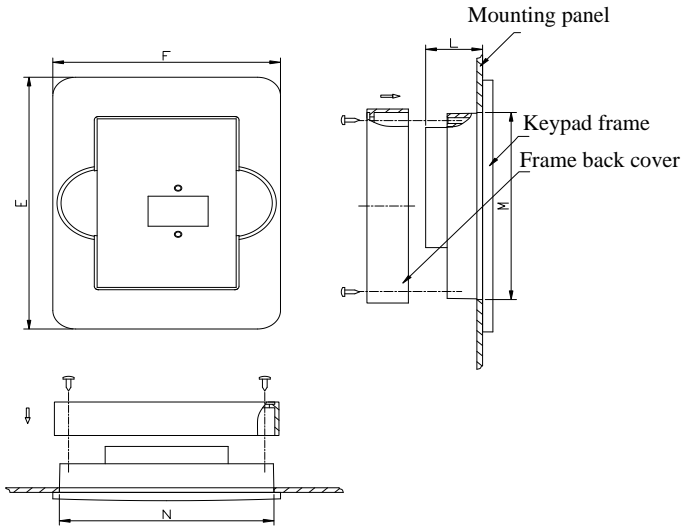

4. Panel mounting size (Unit: mm)

Code	Keypad panel size			Opening size	
	E	F	L	N	M
AA	109	80	20	75	81
A6-1	170	110	22	102	142

5. Port of control panel

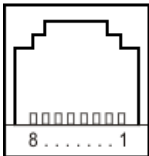







Pins	1	2	3	4	5	6	7	8
8 core	Potentiometer	5V	Grounding	Grounding	Signal 1	Signal 2	Signal 3	Signal 4

6. The default remote-control wire length is 1m. If on the series interference of occasion, or the length is longer than 3m, please put a magnetic ring on the wire to avoid interference.

2.3 Panel Operating

All keys on the panel are available for user. Refer to Table 2-1 for their functions.















Table 2-1 **Uses of Keys**

Keys	Names	Remarks
	Fun	To call function code and switch over display mode.
	Set	To call and save data.
	Up	To increase data (speed control or setting parameters)
	Down	To decrease data (speed control or setting parameters)
	Run	To start inverter;
	Stop or reset	To stop inverter; to reset in fault status; to change function codes in a code group or between two code groups.

2.4 Parameters Setting

This inverter has numerous function parameters, which the user can modify to effect different modes of operation control. User needs to realize that if user sets password valid (F107=1), user's password must be entered first if parameters are to be set after power off or protection is effected, i.e., to call F100 as per the mode in Table 2-2 and enter the correct code. User's password is invalid before delivery, and user could set corresponding parameters without entering password.

Table 2-2 **Steps for Parameters Setting**

Steps	Keys	Operation	Display
1		Press "Fun" key to display function code	
2	 or 	Press "Up" or "Down" to select required function code	
3		To read data set in the function code	
4	 or 	To modify data	
5		To show corresponding target frequency by flashing after saving the set data	
		To display the current function code	

The above-mentioned step should be operated when inverter is in stop status.

2.5 Function Codes Switchover in/between Code-Groups

It has more than 300 parameters (function codes) available to user, divided into 10 sections as indicated in Table 2-3.

Table 2-3 Function Code Partition

Group Name	Function Code Range	Group Name	Function Code Range
Basic Parameters	F1	Timing control and protection function	F7
Run Control Mode	F2	Parameters of the motor	F8
Multi-functional input/output terminal	F3	Communication function	F9
Analog signals and pulse of input/output	F4	PID parameter setting	FA
Multi-stage speed parameters	F5	Torque control	FC
Subsidiary function	F6		

As parameters setting costs time due to numerous function codes, such function is specially designed as “Function Code Switchover in a Code Group or between Two Code-Groups” so that parameters setting become convenient and simple.

Press “Fun” key so that the keypad controller will display function code. If press “▲” or “▼” key then, function code will circularly keep increasing or decreasing by degrees within the group; if press the “stop/reset” key again, function code will change circularly between two code groups when operating the “▲” or “▼” key.

e.g. when function code shows F111 and DGT indicators on, press “▲”/ “▼” key, function code will keep increasing or decreasing by degrees within F100~F160; press “stop/reset” key again, DGT indicator will be off. When pressing “▲”/ “▼” key, function codes will change circularly among the 10 code-groups, like F211, F311...FA11, F111.... Refer to Fig 2-2 (The sparkling “50.00?” is indicated the corresponding target frequency values).

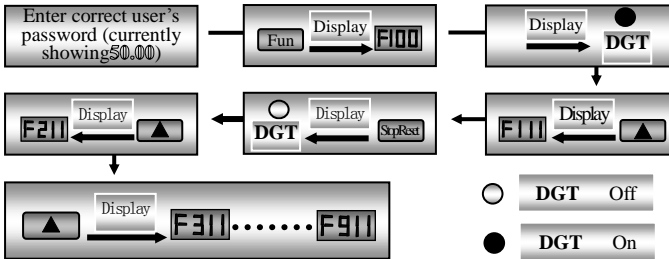

Fig 2-2 Switch over in a Code Group or between Different Code-Groups

2.6 Panel Display

Table 2-4 Items and Remarks Displayed on the Panel

Items	Remarks
HF-0	This Item will be displayed when you press “Fun” in stopping status, which indicates jogging operation is valid. But HF-0 will be displayed only after you change the value of F132.
-HF-	It stands for resetting process and will display target frequency after reset.
OC, OC1, OE, OL1, OL2, OH, LU, PF0, PF1, CE, FL, Err6	Fault code, indicating “over-current OC”, “over-current OC1”, “over-voltage”, “inverter over-load”, “motor over-load” “over-heat”, “under-voltage for input”, “phase loss for input”, and “phase loss for output” “communication timeout”, “speed track fault” and “watchdog fault” respectively.
Err5	PID parameters are set wrong.
ESP	During two-line/three line running mode, “stop/reset” key is pressed or external emergency stop terminal is closed, ESP will be displayed.
F152	Function code (parameter code).
10.00	Indicating inverter’s current running frequency (or rotate speed) and parameter setting values, etc.
50.00	Sparkling in stopping status to display target frequency.
0.	Holding time when changing the running direction. When “Stop” or “Free Stop” command is executed, the holding time can be canceled
A100, U100	Output current (100A) and output voltage (100V). Keep one digit of decimal when current is below 100A.
b*.*	PID feedback value is displayed.
o*.*	PID given value is displayed.
L***	Linear speed is displayed.
H***	Radiator temperature is displayed.

III. Installation & Connection

3.1 Installation

Inverter should be installed vertically, as shown in Fig 3-1. Sufficient ventilation space should be ensured in its surrounding. Clearance dimensions (recommended) are available from Table 3-1 for installing the inverter.

Table 3-1 Clearance Dimensions

Inverter Model	Clearance Dimensions	
Housing (<55 kW)	A≥150mm	B≥100mm
Housing (≥55 kW)	A≥200mm	B≥100mm

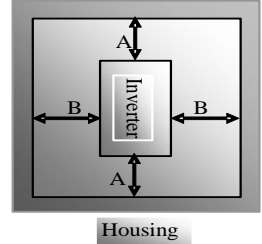
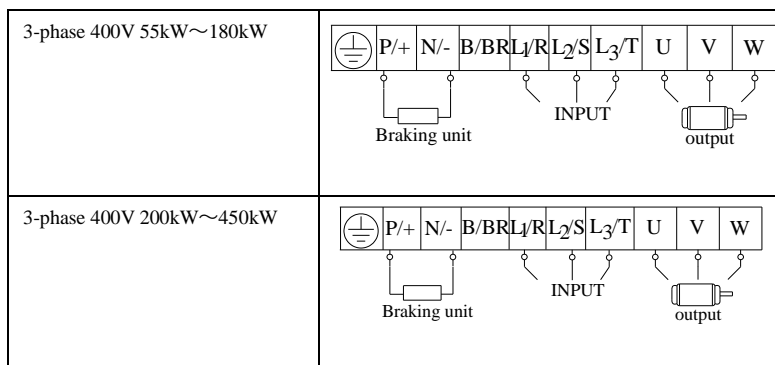

Fig 3- 1 Installation Sketch

3.2 Connection

- Connect R/L1, S/L2 and T/L3 terminals (L1/R and L2/S terminals for single-phase) with power source from network and PE to ground, and U, V and W terminals to motor.
- Motor shall have to be ground connected. Or else electrified motor causes interference.

Model	Sketch
1-phase 230V	
3-phase 230V 0.75~2.2kW and 3-phase 400V 0.75~15kW	
3-phase 400V 18.5kW~45kW	



(The figure is only sketch, terminals order of practical products may be different from the above-mentioned figure.)

Introduction of terminals of power loop

Terminals	Terminal Marking	Terminal Function Description
Power Input Terminal	R/L1, S/L2, T/L3	Input terminals of three-phase 400V AC voltage (R/L1 and S/L2 terminals for single-phase)
Output Terminal	U, V, W	Inverter power output terminal, connected to motor.
Grounding Terminal	PE/E/	Inverter grounding terminal.
Rest Terminal	P/+, B/BR	External braking resistor (Note: no Terminals P or B for inverter without built-in braking unit).
	P/+, N/-	DC bus-line output Externally connected to braking unit P connected to input terminal "P" or "DC+" of braking unit, - connected to input terminal of braking unit "N" or "DC-".

Wiring for control loop as follows:

TA	TB	TC	DO1	DO2	24V	CM	DI1	DI2	DI3	DI4	DI5	DI6	DI7	DI8	10V	A11	A12	GND	AO1	AO2
GND	5V	A+	B-																	

Note: 30 kW and below 30 kW inverters have no DO2, DI7, DI8 control terminals.

3.3 Measurement of main circuit voltages, currents and powers

Since the voltages and currents on the inverter power supply and output sides include harmonics, measurement data depends on the instruments used and circuits measured. When instruments for commercial frequency are used for measurement, measure the following circuits with the recommended instruments.

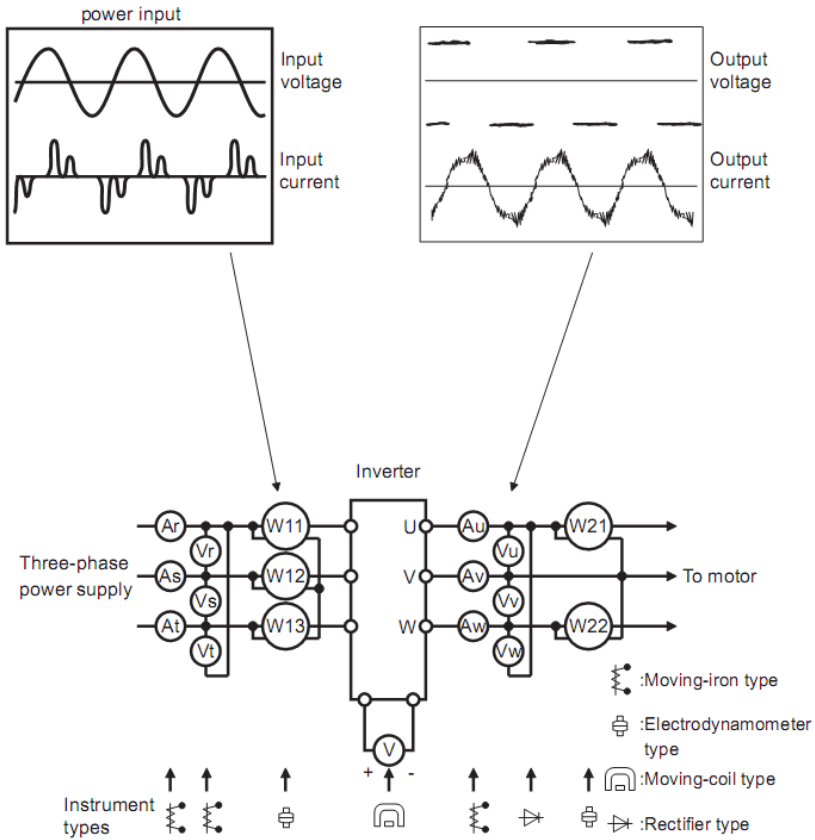

Examples of Measuring Points and Instruments

Item	Measuring Point	Measuring Instrument	Remarks (Reference Measurement Value)
Power supply voltage V1	Across R-S,S-T, T-R	Moving-iron type AC voltmeter	400V ±15%, 230V ±15%
Power supply side current I1	R, S, and T line currents	Moving-iron type AC voltmeter	
Power supply side power P1	At R, S and T, and across R-S, S-T and T-R	Electrodynamic type single-phase wattmeter	P1=W11+W12+W13 (3-wattmeter method)
Power supply side power factor Pf1	Calculate after measuring power supply voltage, power supply side current and power supply side power.[Three phase power supply] $Pf1 = \frac{P1}{\sqrt{3}V1 \times I1} \times 100\%$		
Output side voltage V2	Across U-V, V-W and W-U	Rectifier type AC voltmeter (Moving-iron type cannot measure)	Difference between the phases is within ±1% of the maximum output voltage.
Output side current I2	U, V and W line currents	Moving-iron type AC Ammeter	Current should be equal to or less than rated inverter current. Difference between the phases is 10% or lower of the rated inverter current.
Output side power P2	U, V, W and U-V, V-W,W-U	Electrodynamic type single-phase wattmeter	P2 = W21 + W22 2-wattmeter method
Output side power factor Pf2	Calculate in similar manner to power supply side power factor: $Pf2 = \frac{P2}{\sqrt{3}V2 \times I2} \times 100\%$		
Converter output	Across P and -	Moving-coil type (such as multi-meter)	DC voltage, the value is $\sqrt{2} \times V1$
Power supply of control PCB	Across 10V-GND	Moving-coil type (such as multi-meter)	DC10V ±0.2V
	Across 24V-CM	Moving-coil type (such as multi-meter)	DC24V ±1.5V
Analog output AO1	Across AO1-GND	Moving-coil type (such as multi-meter)	Approx. DC10V at max frequency.
	Across AO2-GND	Moving-coil type (such as multi-meter)	Approx. DC 4~20mA at max frequency
Alarm signal	Across TA/TC Across TB/TC	Moving-coil type (such as multi-meter)	<Normal> <Abnormal> Across TA/TC: Discontinuity Continuity Across TB/TC: Continuity Discontinuity

3.4 Functions of control terminals

The key to operate the inverter is to operate the control terminals correctly and flexibly. Certainly, the control terminals are not operated separately, and they should match corresponding settings of parameters. This chapter describes basic functions of the control terminals. The users may operate the control terminals by combining relevant contents hereafter about “Defined Functions of the Terminals”.

Table 4-3 **Functions of Control Terminals**

Terminal	Type	Description	Function
DO1	Output signal	Multifunctional output terminal 1	When the token function is valid, the value between this terminal and CM is 0V; when the inverter is stopped, the value is 24V.
DO2		Multifunctional output terminal 2	When the token function is valid, the value between this terminal and CM is 0V; when the inverter is stopped, the value is 24V.
TA		Relay contact	TC is a common point, TB-TC are normally closed contacts, TA-TC are normally open contacts. The contact capacity of 15 kW and below 15kW inverter is 10A/125VAC, 5A/250VAC, 5A/30VDC, contact capacity of above 15kW is 12A/125VAC, 7A/250VAC, 7A/30VDC.
TB			
TC			
AO1		Running frequency	It is connected with frequency meter, speedometer or ammeter externally, and its minus pole is connected with GND. See F423~F426 for details,.
AO2	Current display	It is connected with ammeter externally, and its minus pole is connected with GND. See F427~F430 for details	
10V	Analog power supply	Self contained power supply	Internal 10V self-contained power supply of the inverter provides power to the inverter. When used externally, it can only be used as the power supply for voltage control signal, with current restricted below 20mA.
AI1	Input Signal	Voltage analog input port	When analog speed control is adopted, the voltage signal is input through this terminal. The range of voltage input is 0~10V, grounding: GND. When potentiometer speed control is adopted, this terminal is connected with center tap, earth wire to be connected to GND.
AI2		Voltage / Current analog input port	When analog speed control is adopted, the voltage or current signal is input through this terminal. The range of voltage input is 0~5V or 0~10V and the current input is 0~20mA, input resistor is 50Ω, grounding: GND. If the input is 4~20mA, it can be realized through adjusting parameter F406=2. The voltage or current signal can be chosen by coding switch. See table 4-2 and 4-3 for details, and F438 and F439 also should be set accordingly. The default setting of AI1 is 0-10V, and AI2 is 0-20mA.
GND		Self-contained Power supply Ground	Ground terminal of external control signal (voltage control signal or current source control signal) is also the ground of 10V power supply of this inverter.
24V	Power supply	Control power supply	Power: 24±1.5V, grounding: CM; current is restricted below 50mA for external use.
DII	Digital input control terminal	Jogging terminal	When this terminal is in the valid state, the inverter will have jogging running. The jogging function of this terminal is valid under both at stopped and running status.
			The functions of output terminals shall be defined per manufacturer's value. Their initial state may be changed through changing function codes.
			The functions of input terminals shall be defined per manufacturer's value. Other functions can also

DI2		External Emergency Stop	When this terminal is in the valid state, “ESP” malfunction signal will be displayed.	be defined by changing function codes.
DI3		“FWD” Terminal	When this terminal is in the valid state, inverter will run forward.	
DI4		“REV” Terminal	When this terminal is in the valid state, inverter will run reversely.	
DI5		Reset terminal	Make this terminal valid under fault status to reset the inverter.	
DI6		Free-stop	Make this terminal valid during running can realize free stop.	
DI7		Running terminal	When this terminal is in the valid state, inverter will run by the acceleration time.	
DI8		Stop terminal	Make this terminal valid during running can realize stop by the deceleration time.	
CM		Common port	Grounding of control power supply	
A+	485 communication terminals	Positive polarity of differential signal	Standard: TIA/EIA-485(RS-485)	Communication protocol: Modbus Communication rate: 1200/2400/4800/9600/19200/38400/57600bps
B-		Negative polarity of Differential signal		

Note:

1. 30 kW and below 30 kW inverters have no DO2, DI7, DI8 control terminals.

Wiring for digital input terminals:

Generally, shield cable is adopted and wiring distance should be as short as possible. When active signal is adopted, it is necessary to take filter measures to prevent power supply interference. Mode of contact control is recommended.

Digital input terminals are only connected by source electrode (NPN mode) or by drain electrode (PNP mode). If NPN mode is adopted, please turn the toggle switch to the end of “NPN”.

Wiring for control terminals as follows:

1. Wiring for positive source electrode (NPN mode).

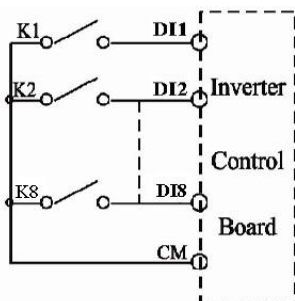

2. Wiring for active source electrode (NPN mode)

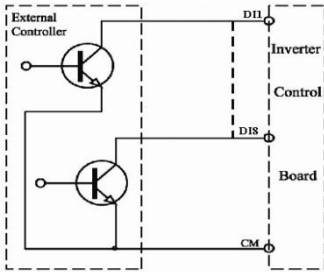

If digital input control terminals are connected by drain electrode, please turn the toggle switch to the end of “PNP”. Wiring for control terminals as follows:

3. Wiring for positive drain electrode (PNP mode)

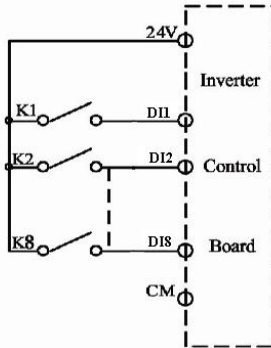

4. Wiring for active drain electrode (PNP mode)

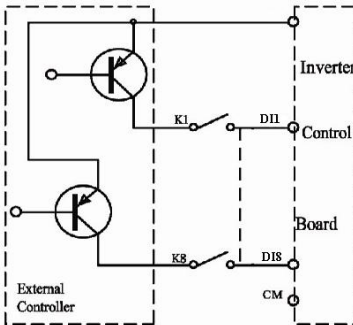

Wiring by source electrode is a mode most in use at present. Wiring for control terminal is connected by source electrode before delivery, user should choose wiring mode according to requirement.

Instructions of choosing NPN mode or PNP mode:

1. There is a toggle switch J7 near to control terminals. Please refer to Fig 3-2.

2. When turning J7 to “NPN”, DI terminal is connected to CM.

When turning J7 to “PNP”, DI terminal is connected to 24V.

3. J7 is on the back of control PCB of single-phase 0.4 kW -0.75 kW.



Fig 3-2 Toggle Switch J7

3.5 Wiring Recommended

Inverter Model	Lead Section Area(mm ²)	Inverter Model	Lead Section Area(mm ²)
E800-0002S2	1.5	E800-0150T3	10
E800-0004S2	1.5	E800-0185T3	16
E800-0005S2	2.5	E800-0220T3	16
E800-0007S2	2.5	E800-0300T3	25
E800-0011S2	2.5	E800-0370T3	25
E800-0015S2	2.5	E800-0450T3	35
E800-0022S2	4.0	E800-0550T3	35
E800-0007T2	2.5	E800-0750T3	50
E800-0015T2	2.5	E800-0900T3	70
E800-0022T2	4.0	E800-1100T3	70
E800-0002T3	1.5	E800-1320T3	95
E800-0004T3	1.5	E800-1600T3	120
E800-0005T3	1.5	E800-1800T3	120
E800-0007T3	1.5	E800-2000T3	150
E800-0011T3	2.5	E800-2200T3	185
E800-0015T3	2.5	E800-2500T3	240
E800-0022T3	2.5	E800-2800T3	240
E800-0030T3	2.5	E800-3150T3	300
E800-0040T3	2.5	E800-3550T3	300
E800-0055T3	4.0	E800-4000T3	400
E800-0075T3	4.0	E800-4500T3	480
E800-0110T3	6.0		

3.6 Lead section area of protect conductor (grounding wire)

Lead section area S of U,V,W (mm ²)	Min lead section area of \oplus/\ominus /PE/E(mm ²)
$S \leq 16$	S
$16 < S \leq 35$	16
$35 < S$	S/2

3.7 Overall Connection and “Three- Line” Connection

* Refer to next figure for overall connection sketch for E800 series inverters. Wiring mode is available for various terminals whereas not every terminal needs connection when applied.

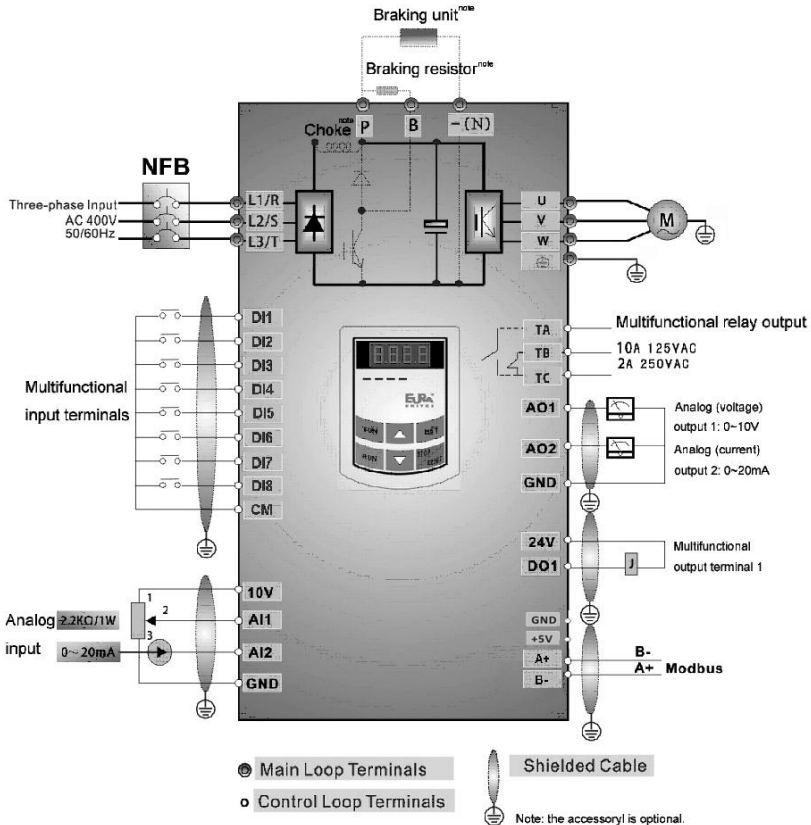

Basic Wiring Diagram for multi-stage speed control macro (NPN type)

Note:

1. Please only connect power terminals L1/R and L2/S with power grid for single-phase inverters.
2. For 30kw inverters and below 30kw, the remote panel is connected by 8-core net cable. And 485 communication port is at the side of inverter.
3. 37kW inverter and above 37 kW have 8 multifunctional input terminals DI1~DI8, inverters below 37kW have 6 multifunctional input terminals DI1~DI6.
4. The contact capacity of below 37 kW inverters is 10A/125VAC, 5A/250VAC, 5A/30VDC, contact capacity of 37kw and above 37 kW is 12A/125VAC, 7A/250VAC and 7A/30VDC.

3.8 Basic methods of suppressing the noise

The noise generated by the drive may disturb the equipment nearby. The degree of disturbance is dependent on the drive system, immunity of the equipment, wiring, installation clearance and earthing methods.

3.8.1 Noise propagation paths and suppressing methods

① Noise categories

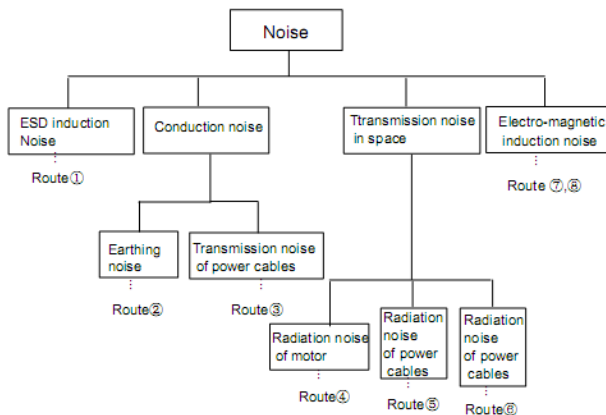

② Noise propagation paths

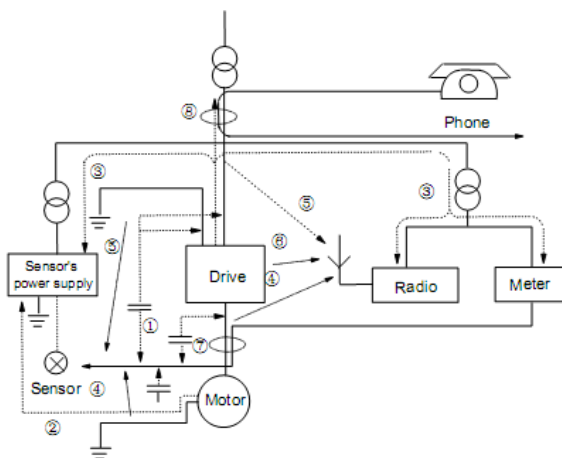

③ Basic methods of suppressing the noise

Noise emission paths	Actions to reduce the noise
②	When the external equipment forms a loop with the drive, the equipment may suffer nuisance tripping due to the drive's earth leakage current. The problem can be solved if

	the equipment is not grounded.
③	If the external equipment shares the same AC supply with the drive, the drive's noise may be transmitted along its input power supply cables, which may cause nuisance tripping to other external equipment. Take the following actions to solve this problem: Install noise filter at the input side of the drive, and use an isolation transformer or line filter to prevent the noise from disturbing the external equipment.
④⑤⑥	If the signal cables of measuring meters, radio equipment and sensors are installed in a cabinet together with the drive, these equipment cables will be easily disturbed. Take the actions below to solve the problem: (1) The equipment and the signal cables should be as far away as possible from the drive. The signal cables should be shielded and the shielding layer should be grounded. The signal cables should be placed inside a metal tube and should be located as far away as possible from the input/output cables of the drive. If the signal cables must cross over the power cables, they should be placed at right angle to one another. (2) Install radio noise filter and linear noise filter (ferrite common-mode choke) at the input and output of the drive to suppress the emission noise of power lines. (3) Motor cables should be placed in a tube thicker than 2mm or buried in a cement conduit. Power cables should be placed inside a metal tube and be grounded by shielding layer
①⑦⑧	Don't route the signal cables in parallel with the power cables or bundle these cables together because the induced electro-magnetic noise and induced ESD noise may disturb the signal cables. Other equipment should also be located as far away as possible from the drive. The signal cables should be placed inside a metal tube and should be placed as far away as possible from the input/output cables of the drive. The signal cables and power cables should be shielded cables. EMC interference will be further reduced if they could be placed inside metal tubes. The clearance between the metal tubes should be at least 20cm.

3.8.2 Field Wire Connections

Control cables, input power cables and motor cables should be installed separately, and enough clearance should be left among the cables, especially when the cables are laid in parallel and the cable length is big. If the signal cables must go through the power cables, they should be vertical to each other.

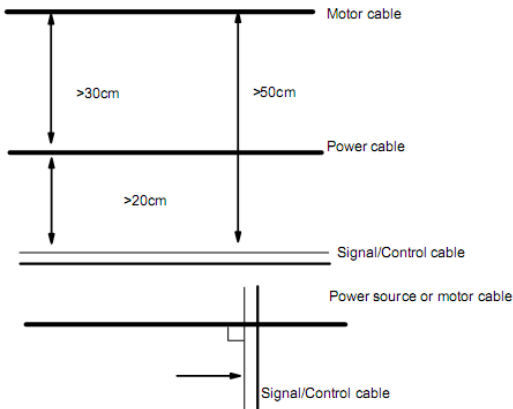

Generally, the control cables should be shielded cables and the shielding metal net must be connected to the metal enclosure of the drive by cable clamps.

3.8.3 Earthing

Independent earthing poles (best)

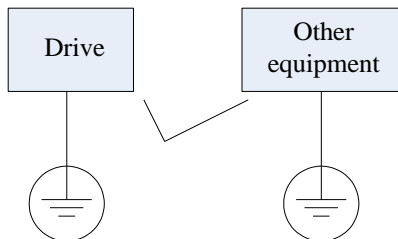

Shared earthing pole (good)

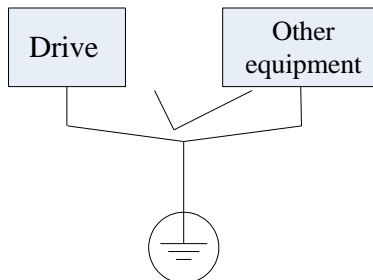

Shared earthing cable (not good)

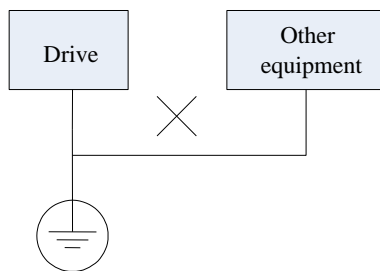
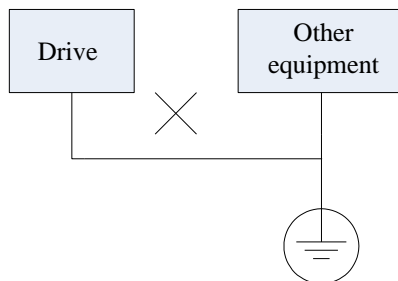

Note:

1. In order to reduce the earthing resistance, flat cable should be used because the high frequency impedance of flat cable is smaller than that of round cable with the same CSA.
2. If the earthing poles of different equipment in one system are connected together, then the leakage current will be a noise source that may disturb the whole system. Therefore, the drive's earthing pole should be separated with the earthing pole of other equipment such as audio equipment, sensors and PC, etc.
3. Earthing cables should be as far away from the I/O cables of the equipment that is sensitive to noise, and also should be as short as possible.

3.8.4 Leakage current

Leakage current may flow through the drive's input and output capacitors and the motor's capacitor. The leakage current value is dependent on the distributed capacitance and carrier wave frequency. The leakage current includes ground leakage current and the leakage current between lines.

Ground leakage current

The ground leakage current can not only flow into the drive system, but also other equipment via earthing cables. It may cause the leakage current circuit breaker and relays falsely activated. The higher the drive's carrier wave frequency, the bigger the leakage current, also, the longer the motor cable, the greater the leakage current,

Suppressing methods:

- Reduce the carrier wave frequency, but the motor noise may be louder;
- Motor cables should be as short as possible;
- The drive and other equipment should use leakage current circuit breaker designed for protecting the product against high-order harmonics/surge leakage current;

Leakage current between lines

The line leakage current flowing through the distribution capacitors of the drive out side may cause the thermal relay falsely activated, especially for the drive whose power is lower than 7.5kW. When the cable is longer than 50m, the ratio of leakage current to motor rated current may be increased that can cause the wrong action of external thermal relay very easily.

Suppressing methods:

- Reduce the carrier wave frequency, but the motor noise may become louder;
- Install reactor at the output side of the drive.

In order to protect the motor reliably, it is recommended to use a temperature sensor to detect the motor's temperature, and use the drive's over-load protection device (electronic thermal relay) instead of an external thermal relay.

3.8.5 Electrical installation of the drive

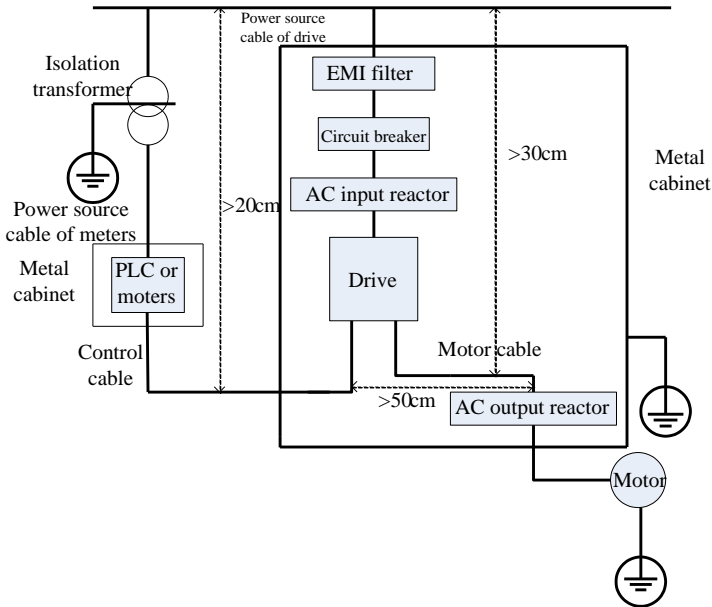

Note:

- Motor cable should be earthed at the drive side, if possible, the motor and drive should be earthed separately;
- Motor cable and control cable should be shielded. The shield must be earthed and avoid entangling at cable end to improve high frequency noise immunity.
- Assure good conductivity among plates, screw and metal case of the drive; use tooth-shape washer and

conductive installation plate;

3.8.6 Application of Power Line Filter

Power source filter should be used in the equipment that may generate strong EMI or the equipment that is sensitive to the external EMI. The power source filter should be a two-way low pass filter through which only 50Hz current can flow and high frequency current should be rejected.

Function of power line filter

The power line filter ensures the equipment can satisfy the conducting emission and conducting sensitivity in EMC standard. It can also suppress the radiation of the equipment.

Common mistakes in using power cable filter

1. Too long power cable

The filter inside the cabinet should be located near to the input power source. The length of the power cables should be as short as possible.

2. The input and output cables of the AC supply filter are too close

The distance between input and output cables of the filter should be as far apart as possible, otherwise the high frequency noise may be coupled between the cables and bypass the filter. Thus, the filter will become ineffective.

3. Bad earthing of filter

The filter's enclosure must be earthed properly to the metal case of the drive. In order to be earthed well, make use of a special earthing terminal on the filter's enclosure. If you use one cable to connect the filter to the case, the earthing is useless for high frequency interference. When the frequency is high, so is the impedance of cable, hence there is little bypass effect. The filter should be mounted on the enclosure of equipment. Ensure to clear away the insulation paint between the filter case and the enclosure for good earthing contact.

IV. Operation and Simple Running

This chapter defines and interprets the terms and nouns describing the control, running and status of the inverter. Please read it carefully. It will be helpful to your correct operation.

4.1 Basic conception

4.1.1 Control mode

Control mode of E800 inverter is VVVF control (F106=2), sensorless vector control (F106=0), and vector control 1 (F106=3), PMSM vector control (F106=6).

4.1.2 Mode of torque compensation

Linear compensation (F137=0); Square compensation (F137=1); User-defined multipoint compensation (F137=2); Auto torque compensation (F137=3)

4.1.3 Mode of frequency setting

Please refer to F203~F207 for the method for setting the running frequency of the E800 inverter.

4.1.4 Mode of controlling for running command

The channel for inverter to receive control commands (including start, stop and jogging, etc) contains 5 modes: 0. Keypad control; 1. Terminal control; 2. Keypad + terminal control 3. Modbus control; 4. Keypad + terminal +Modbus

The modes of control command can be selected through the function codes F200 and F201.

4.1.5 Operating status of inverter

When the inverter is powered on, it may have four kinds of operating status: stopped status, programming status, running status, and fault alarm status. They are described in the following:

Stopped status

If re-energize the inverter (if “auto-startup after being powered on” is not set) or decelerate the inverter to stop, the inverter is at the stopping status until receiving control command. At this moment, the running status indicator on the keypad goes off, and the display shows the display status before power down.

Programming status

Through keypad panel, the inverter can be switched to the status that can read or change the function code parameters. Such a status is the programming status.

There are numbers of function parameters in the inverter. By changing these parameters, the user can realize different control modes.

Running status

The inverter at the stopped status or fault-free status will enter running status after having received operation command.

The running indicator on keypad panel lights up under normal running status.

Fault alarm status

The status under which the inverter has a fault and the fault code is displayed.

Fault codes mainly include: OC, OE, OL1, OL2, OH, LU, PF1, PF0 representing “over current”, “over voltage”, “inverter overload”, “motor overload”, “overheat”, “input undervoltage”, “input phase loss”, and “output phase loss” respectively.

For trouble shooting, please refer to Appendix I to this manual, “Trouble Shooting”.

4.2 Keypad panel and operation method

Keypad panel (keypad) is a standard part for configuration of E800 inverter. Through keypad panel, the user

may carry out parameter setting, status monitoring and operation control over the inverter. Both keypad panel and display screen are arranged on the keypad controller, which mainly consists of three sections: data display section, status indicating section, and keypad operating section. There are two types of keypad controller (with potentiometer or without potentiometer) for inverter. For details, please refer to Chapter II of this manual, "Keypad panel".

It is necessary to know the functions and how to use the keypad panel. Please read this manual carefully before operation.

4.2.1 Method of operating the keypad panel

(1) Operation process of setting the parameters through keypad panel

A three-level menu structure is adopted for setting the parameters through keypad panel of inverter, which enables convenient and quick searching and changing of function code parameters.

Three-level menu: Function code group (first-level menu) → Function code (second-level menu) → Set value of each function code (third-level menu).

(2) Setting the parameters

Setting the parameters correctly is a precondition to give full play of inverter performance. The following is the introduction on how to set the parameters through keypad panel.

Operating procedures:

- ① Press the "Fun" key, to enter programming menu.
- ② Press the key "Stop/Reset", the DGT lamp goes out. Press ▲ and ▼, the function code will change within the function code group. The first number behind F displayed on the panel is 1, in other words, it displays F1××at this moment.
- ③ Press the key "Stop/Reset" again, the DGT lamp lights up, and the function code will change within the code group. Press ▲ and ▼ to change the function code to F113; press the "Set" key to display 50.00; while press ▲ and ▼ to change to the need frequency.
- ④ Press the "Set" key to complete the change.

4.2.2 Switching and displaying of status parameters

Under stopped status or running status, the LED digitron of inverter can display status parameters of the inverter. Actual parameters displayed can be selected and set through function codes F131 and F132. Through the "Fun" key, it can switch over repeatedly and display the parameters of stopped status or running status. The followings are the description of operation method of displaying the parameters under stopped status and running status.

(1) Switching of the parameters displayed under stopped status

Under stopped status, inverter has five parameters of stopped status, which can be switched over repeatedly and displayed with the keys "Fun" and "Stop/Reset". These parameters are displaying: keypad jogging, target rotary speed, PN voltage, PID feedback value, and temperature. Please refer to the description of function code F132.

(2) Switching of the parameters displayed under running status

Under running status, eight parameters of running status can be switched over repeatedly and displayed with the keys "Fun". These parameters are displayed: output rotary speed, output current, output voltage, PN voltage, PID feedback value, temperature, count value and linear speed. Please refer to the description of function code F131.

4.2.3 Operation process of measuring motor stator resistance parameters

The user shall input the parameters accurately as indicated on the nameplate of the motor prior to selecting auto torque compensation (F137=3). Inverter will tune motor parameters according to these parameters indicated on the nameplate. To achieve better control performance, the user may start the inverter to tune the motor parameters, so as to obtain accurate parameters of the motor controlled.

The motor parameters can be tuned through function code F800.

For example: If the parameters indicated on the nameplate of the motor controlled are as follows: numbers of motor poles are 4; rated power is 7.5 kW; rated voltage is 400V; rated current is 15.4A; rated frequency is

50.00HZ; and rated rotary speed is 1440rpm, operation process of measuring the parameters shall be done as described in the following:

1. In accordance with the above motor parameters, set the values of F801 to F805 correctly: set the value of F801 = 7.5, F802 = 400, F803 = 15.4, F804 = 4, and F805 = 1440 respectively.
2. In order to ensure dynamic control performance of the inverter, set F800=1. Press the “Run” key on the keypad, and the inverter will display “TEST”, after few seconds, auto-checking is completed, motor stator resistance parameters will be stored in function code F806, and F800 will turn to 0 automatically.

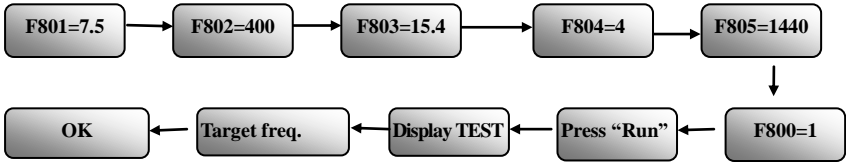

Note: When F137 is set to 3, it is used to increase torque in low frequency. And the stator resistance of motor should be tested. One inverter can only drive one motor. If users want to drive several motors, please set F137 to the other values.

4.2.4 Operation process of simple running

Table 4-1 Brief Introduction to Inverter Operation Process

Process	Operation	Reference
Installation and operation environment	Install the inverter at a location meeting the technical specifications and requirements of the product. Mainly take into consideration the environment conditions (temperature, humidity, etc) and heat radiation of the inverter, to check whether they can satisfy the requirements.	See Chapters I, II, III.
Wiring of the inverter	Wiring of input and output terminals of the main circuit; wiring of grounding; wiring of switching value control terminal, analog terminal and communication interface, etc.	See Chapter III.
Checking before getting energized	Make sure that the voltage of input power supply is correct; the input power supply loop is connected with a breaker; the inverter has been grounded correctly and reliably; the power cable is connected to the power supply input terminals of inverter correctly (R/L1, S/L2 terminals for single-phase power grid, and R/L1, S/L2, and T/L3 for three-phase power grid); the output terminals U, V, and W of the inverter are connected to the motor correctly; the wiring of control terminals is correct; all the external switches are preset correctly; and the motor is under no load (the mechanical load is disconnected from the motor).	See Chapters I~III
Checking immediately after energized	Check if there is any abnormal sound, fuming or foreign flavor with the inverter. Make sure that the display of keypad panel is normal, without any fault alarm message. In case of any abnormality, switch off the power supply immediately.	See Appendix 1 and Appendix 2.
Inputting the parameters indicated on the motor's nameplate correctly, and measuring the motor stator resistance parameters.	Make sure to input the parameters indicated on the motor nameplate correctly, and measure the motor stator resistance parameters to get the best control performance.	See description of parameter group F800~F830

Setting running control parameters	Set the parameters of the inverter and the motor correctly, which mainly include target frequency, upper and lower frequency limits, acceleration/deceleration time, and direction control command, etc. The user can select corresponding running control mode according to actual applications.	See description of parameter group.
Checking under no load	With the motor under no load, start the inverter with the keypad or control terminal. Check and confirm running status of the drive system. Motor's status: stable running, normal running, correct rotary direction, normal acceleration/deceleration process, free from abnormal vibration, abnormal noise and foreign flavor. Inverter's status: normal display of the data on keypad panel, normal running of the fan, normal acting sequence of the relay, free from the abnormalities like vibration or noise. In case of any abnormality, stop and check the inverter immediately.	See Chapter IV.
Checking under with load	After successful test run under no load, connect the load of drive system properly. Start the inverter with the keypad or control terminal, and increase the load gradually. When the load is increased to 50% and 100%, keep the inverter run for a period respectively, to check if the system is running normally. Carry out overall inspection over the inverter during running, to check if there is any abnormality. In case of any abnormality, stop and check the inverter immediately.	
Checking during running	Check if the motor is running stably, if the rotary direction of the motor is correct, if there is any abnormal vibration or noise when the motor is running, if the acceleration/deceleration process of the motor is stable, if the output status of the inverter and the display of keypad panel is correct, if the blower fan is run normally, and if there is any abnormal vibration or noise. In case of any abnormality, stop the inverter immediately, and check it after switching off the power supply.	

4.3 Illustration of basic operation

Illustration of inverter basic operation: we hereafter show various basic control operation processes by taking a 7.5kW inverter that drives a 7.5kW three-phase asynchronous AC motor as an example.

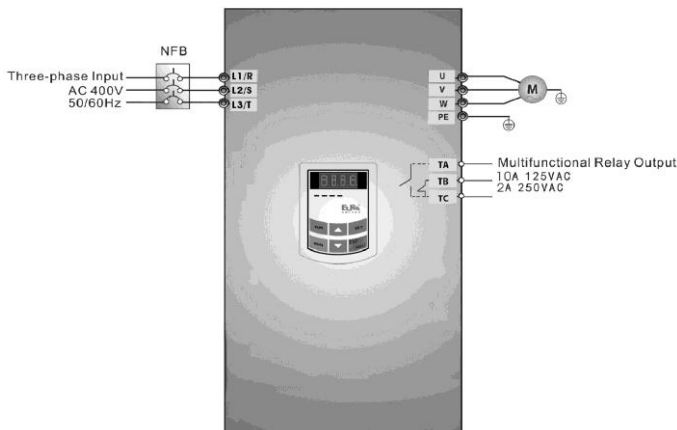

Figure 4-1 Wiring Diagram 1

The parameters indicated on the nameplate of the motor are as follows: 4 poles; rated power, 7.5 kW; rated voltage, 400V; rated current, 15.4A; rated frequency 50.00HZ; and rated rotary speed, 1440rpm.

4.3.1 Operation processes of frequency setting, start, forward running and stop with keypad panel

- (1) Connect the wires in accordance with Figure 4-1. After having checked the wiring successfully, switch on the air switch, and power on the inverter.
- (2) Press the “Fun” key, to enter the programming menu.
- (3) When F137=3, measure the parameters of motor stator resistance parameter. When F137≠3, go to step 4.

Function	Values
F800	1
F801	7.5
F802	400
F803	15.4
F805	1440

Press the “Run” key, to measure the parameters of the motor. After completion of the measurement, and relevant parameters will be stored in F806. For the details of measurement of motor parameters, please refer to “Operation process of measuring the motor parameters” in this manual and Chapter XII of this manual.

- (4) Set functional parameters of the inverter:

Function code	Values
F111	50.00
F200	0
F201	0
F202	0
F203	0

- (5) Press the “Run” key, to start the inverter;
- (6) During running, current frequency of the inverter can be changed by pressing ▲ or ▼;
- (7) Press the “Stop/Reset” key once, the motor will decelerate until it stops running;
- (8) Switch off the air switch, and power off the inverter.

4.3.2 Operation process of setting the frequency with keypad panel, and starting, forward and reverse running, and stopping inverter through control terminals

- (1) Connect the wires in accordance with Figure 4-2. After having checked the wiring successfully, switch on the air switch, and power on the inverter;

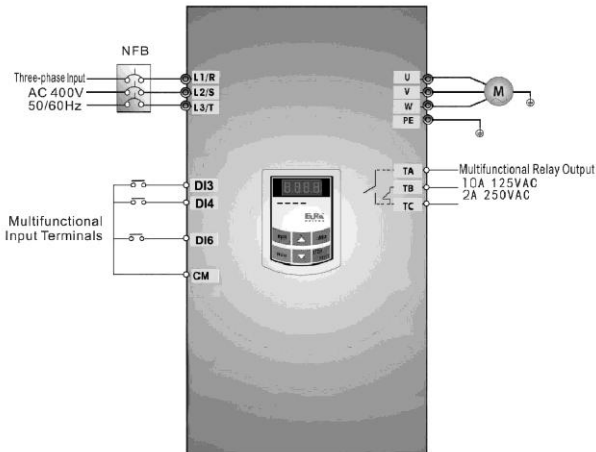

Figure 4-2 Wiring Diagram 2

- (2) Press the “Fun” key, to enter the programming menu.

- (3) Study the parameters of the motor: the operation process is the same as that of example 1.
 (4) Set functional parameters of the inverter:

Function code	Values
F111	50.00
F203	0
F208	1

- (5) Close the switch DI3, the inverter starts forward running;
 (6) During running, current frequency of the inverter can be changed by pressing ▲ or ▼;
 (7) During running, switch off the switch DI3, then close the switch DI4, the running direction of the motor will be changed (Note: The user should set the dead time of forward and reverse running F120 on the basis of the load. If it was too short, OC protection of the inverter may occur.)
 (8) Switch off the switches DI3 and DI4, the motor will decelerate until it stops running;
 (9) Switch off the air switch, and power off the inverter.

4.3.3 Operation process of jogging operation with keypad panel

- (1) Connect the wires in accordance with Figure 4-1. After having checked the wiring successfully, switch on the air switch, and power on the inverter;
 (2) Press the “Fun” key, to enter the programming menu.
 (3) Study the parameters of the motor: the operation process is the same as that of example 1.
 (4) Set functional parameters of the inverter:

Function code	Values
F124	5.00
F125	30
F126	30
F132	1
F202	0

- (5) Press and hold the “Run” key until the motor is accelerated to the jogging frequency, and maintain the status of jogging operation.
 (6) Release the “Run” key. The motor will decelerate until jogging operation is stopped;
 (7) Switch off the air switch, and power off the inverter.

4.3.4 Operation process of setting the frequency with analog terminal and controlling the operation with control terminals

- (1) Connect the wires in accordance with Figure 4-3. After having checked the wiring successfully, switch on the air switch, and power on the inverter. Note: 2K~5K potentiometer may be adopted for setting external analog signals. For the cases with higher requirements for precision, please adopt precise multiturn potentiometer, and adopt shielded wire for the wire connection, with near end of the shielding layer grounded reliably.

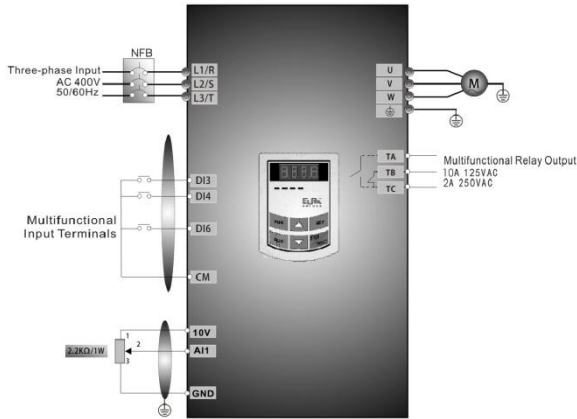
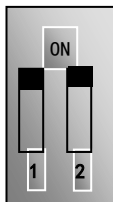

Figure 4-3 Wiring Diagram 3

- (2) Press the “Fun” key, to enter the programming menu.
- (3) Study the parameters of the motor: the operation process is the same as that of example 1.
- (4) Set functional parameters of the inverter:

Function code	Values
F203	1
F208	1

- (5) There is a red two-digit coding switch SW1 near the control terminal block of 30kW inverter and below 30 kW , as shown in Figure 4-4. The function of coding switch is to select the voltage signal (0~5V/0~10V) or current signal of analog input terminal AI2, current channel is default. In actual application, select the analog input channel by F203. And select voltage or current signal by F439. Turn switches 1 to ON and 2 to ON as illustrated in the figure, and select 0~20mA current speed control. Another switches states and mode of control speed are as table 4-2.
- (6) There is a red four-digit coding switch SW1 near the control terminal block of above 37 kW inverter, as shown in Figure 4-5. The function of coding switch is to select the input range (0~5V/0~10V/0~20mA) of analog input terminal AI1 and AI2. In actual application, select the analog input channel through F203. And select voltage or current signal by F438 and F439. AI1 channel default value is 0~10V, AI2 channel default value is 0~20mA. Another switches states and mode of control speed are as table 4-3.
- (7) Close the switch DI3, the motor starts forward running;
- (8) The potentiometer can be adjusted and set during running, and the current setting frequency of the inverter can be changed;
- (9) During running, switch off the switch DI3, then, close DI4, the running direction of the motor will be changed;
- (10) Switch off the switches DI3 and DI4, the motor will decelerate until it stops running;
- (11) Switch off the air switch, and power off the inverter.
- (12) Analog output terminal AO2 can only output current signal, AO1 terminal can output voltage and current signal, the selecting switch is J5, please refer to Fig 4-6, the output relation is shown in table 4-4



SW1

Fig 4-4

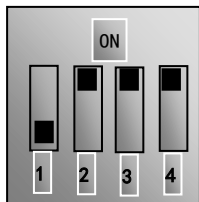

SW1

Fig 4-5

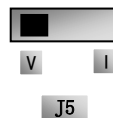

Fig 4-6

Table 4-2 The Setting of Coding Switch and Parameters in the Mode of Analog Speed Control

F203=2, channel AI2 is selected				F203=1, channel AI1 is selected
Parameter	SW1 coding switch			0~10V voltage
F439	Coding Switch 1	Coding Switch 2	Mode of Speed Control	
0	OFF	OFF	0~5V voltage	
0	OFF	ON	0~10V voltage	
1	ON	ON	0~20mA current	

Table 4-3 The Setting of Coding Switch and Parameters in the Mode of Analog Speed Control

Para.	Set F203 to 1, to select channel AI1				Set F203 to 2, to select channel AI2			
	Coding Switch SW1		Toggle switch S1	Analog signal range	Coding Switch SW1		Analog signal range	
F438	Switch 1	Switch 3			F439	Switch 2		Switch 4
0	OFF	OFF	+	0~5V voltage	0	OFF	OFF	0~5V voltage
0	OFF	ON	+	0~10V voltage	0	OFF	ON	0~10V voltage
1	ON	ON	+	0~20mA current	1	ON	ON	0~20mA current
0	OFF	ON	-	-10~10V voltage				
	OFF	OFF	-	Reserved				
	ON	ON	-	Reserved				

ON refers to switching the coding switch to the top, OFF refers to switching the coding switch to the bottom

Table 4-4 The relationship between AO1 and J5 and F423

AO1 output		Setting of F423		
		0	1	2
J5	V	0~5V	0~10V	Reserved
	I	Reserved	0~20mA	4~20mA

V. Function Parameters

5.1 Basic parameters

F100	User's Password	Setting range: 0~9999	Mfr's value: 0
------	-----------------	-----------------------	----------------

·When F107=1 with valid password, the user must enter correct user's password after power on or fault reset if you intend to change parameters. Otherwise, parameter setting will not be possible, and a prompt "Err1" will be displayed.

Relating function code: F107 Password valid or not
F108 Setting user's password

F102	Inverter's Rated Current (A)		Mfr's value: Subject to inverter model
F103	Inverter Power (kW)		Mfr's value: Subject to inverter model

·Rated current and rated power can only be checked but cannot be modified.

F105	Software Edition No.		Mfr's value: Subject to inverter model
------	----------------------	--	--

Software Edition No. can only be checked but cannot be modified.

F106	Control mode	Setting range: 0: Sensorless vector control (SVC); 2: VVVF; 3: Vector control 1 6: PMSM sensorless vector control	Mfr's value: 2
------	--------------	---	----------------

0: Sensorless vector control is suitable for the application of high-performance requirement. One inverter can only drive one motor.

2: VVVF control is suitable for common requirement of control precision.

6: PMSM sensorless vector control is suitable for the application of high-performance requirement. One inverter can only drive one motor.

Note:

1. It is necessary to study the parameters of motor before inverter runs in the vector control mode (F106=0, 3 or 6).
2. Under vector control mode (F106=0, 3 or 6), one inverter can only drive one motor and the power of motor should be similar to the power of inverter. Otherwise, control performance will be increased or system cannot work properly.
3. Under vector control mode (F106=0), the max frequency (F111) must be lower than 500.00Hz.
4. The operator may input motor parameters manually according to the motor parameters given by motor manufactures.
5. Usually, the motor will work normally by inverter's default parameters, but the inverter's best control performance will not be acquired. Therefore, in order to get the best control performance, please study the parameters of motor before inverter runs in the vector control mode.
6. In vector control mode and auto torque control mode, F641 must be set to 0 to avoid malfunction and motor damaged.

F107	Password Valid or Not	Setting range: 0: invalid; 1: valid	Mfr's value: 0
F108	Setting User's Password	Setting range: 0~9999	Mfr's value: 8

·When F107 is set to 0, the function codes can be changed without inputting the password. When F107 is set to 1, the function codes can be changed only after inputting the user's password by F100.

·The user can change "User's Password". The operation process is the same as those of changing other

parameters.

· Input the value of F108 into F100, and the user's password can be unlocked.

Note: When password protection is valid, and if the user's password is not entered, F108 will display 0.

F109	Starting Frequency (Hz)	Setting range: 0.00~10.00	Mfr's value: 0.00
F110	Holding Time of Starting Frequency (S)	Setting range: 0.0~999.9	Mfr's value: 0.0

The inverter begins to run from the starting frequency. If the target frequency is lower than starting frequency, F109 is invalid.

The inverter begins to run from the starting frequency. After it keeps running at the starting frequency for the time as set in F110, it will accelerate to target frequency. The holding time is not included in acceleration/deceleration time.

Starting frequency is not limited by the Min frequency set by F112. If the starting frequency set by F109 is lower than Min frequency set by F112, inverter will start according to the setting parameters set by F109 and F110. After inverter starts and runs normally, the frequency will be limited by frequency set by F111 and F112.

Starting frequency should be lower than Max frequency set by F111.

If starting frequency is lower than target frequency set by F113, starting frequency will be invalid.

Note: when speed track is adopted, F109 and F110 are invalid.

F111	Max Frequency (Hz)	Setting range: F113~590.0	Mfr's value: 50.00
F112	Min Frequency (Hz)	Setting range: 0.00~F113	Mfr's value: 0.50

·Max frequency is set by F111.

·Min frequency is set by F112.

·The setting value of min frequency should be lower than target frequency set by F113.

·The inverter begins to run from the starting frequency. During inverter running, if the given frequency is lower than min frequency, then inverter will run at min frequency until inverter stops or given frequency is higher than min frequency.

Max/Min frequency should be set according to the nameplate parameters and running situations of motor. The motor is forbidden running at low frequency for a long time, or else motor will be damaged because of overheat.

F113	Target Frequency (Hz)	Setting range: F112~F111	Mfr's value: 50.00
------	-----------------------	--------------------------	--------------------

·Max frequency is set by F111.

·Min frequency is set by F112.

·The setting value of min frequency should be lower than target frequency set by F113.

F114	First Acceleration Time (S)	Setting range: 0.1~3000	Mfr's value: Subject to inverter model
F115	First Deceleration Time (S)		
F116	Second Acceleration Time (S)		
F117	Second Deceleration Time (S)		
F277	Third Acceleration Time (S)		
F278	Third Deceleration Time (S)		
F279	Fourth Acceleration Time (S)		
F280	Fourth Deceleration Time (S)		

The reference of setting accel/decel time is set by F119.

·When speed track is working, acceleration/deceleration time, min frequency and target frequency are invalid. After speed track is finished, inverter will run to target frequency according to acceleration/deceleration time.

F118	Turnover Frequency (Hz)	Setting range: 15.00~590.0	Mfr's value: 50.00
------	-------------------------	----------------------------	--------------------

· Turnover frequency is the final frequency of V/F curve, and also is the least frequency according to the highest output voltage.

When running frequency is lower than this value, inverter has constant-torque output. When running frequency exceeds this value, inverter has constant-power output.

Note: during the process of speed track, turnover frequency is invalid. After speed track is finished, this function code is valid.

F119 The reference of setting accel/decel time	Setting range: 0: 0~50.00Hz 1: 0~F111	Mfr's value: 0
--	--	----------------

When F119=0, acceleration/ deceleration time means the time for inverter to accelerate/ decelerate from 0Hz (50Hz) to 50Hz (0Hz).

When F119=1, acceleration/ deceleration time means the time for inverter to accelerate/ decelerate from 0Hz (max frequency) to max frequency (0Hz).

F120 Forward / Reverse Switchover dead-Time (S)	Setting range: 0.0~3000	Mfr's value: 0.0
---	-------------------------	------------------

· Within “forward/ reverse switchover dead-time”, this latency time will be cancelled upon inverter receiving “stop” signal. This function is suitable for all the speed control modes except automatic cycle operation.

· This function can ease the current impact in the process of direction switchover.

Note: during the process of speed track, F120 is invalid. After speed track is finished, this function code is valid.

F122 Reverse Running Forbidden	Setting range: 0: invalid; 1: valid	Mfr's value: 0
--------------------------------	-------------------------------------	----------------

When F122=1, inverter will only run forward no matter the state of terminals and the parameters set by F202. Inverter will not run reverse and forward / reverse switchover is forbidden. If reverse signal is given, inverter will stop.

If reverse running locking is valid (F202=1), whatever speed track is valid or not, inverter has no output.

When F122=1, F613=1, F614≥2 and inverter gets forward running command and motor is sliding reverse, if inverter can detect the sliding direction and track to motor speed, then inverter will run to 0.0Hz reverse, then run forward according to the setting value of parameters.

F123 Minus frequency is valid in the mode of combined speed control.	0: Invalid; 1: valid	0
--	----------------------	---

In the mode of combined speed control, if running frequency is minus and F123=0, inverter will run at 0Hz; if F123=1, inverter will run reverse at this frequency. (This function is controlled by F122.)

F124 Jogging Frequency (Hz)	Setting range: F112~F111	Mfr's value: 5.00
F125 Jogging Acceleration Time (S)	Setting range: 0.1~3000	Mfr's value: Subject to inverter model
F126 Jogging Deceleration Time (S)		

There are two types of jogging: keypad jogging and terminal jogging. Keypad jogging is valid only under stopped status (F132 including of displaying items of keypad jogging should be set). Terminal jogging is valid under both running status and stopped status.

Carry out jogging operation through the keypad (under stopped status):

- a. Press the “Fun” key, it will display “HF-0”;
- b. Press the “Run” key, the inverter will run to “jogging frequency” (if pressing “Fun” key again, “keypad jogging” will be cancelled).

· In case of terminal jogging, make “jogging” terminal (such as D11) connected to CM, and inverter will

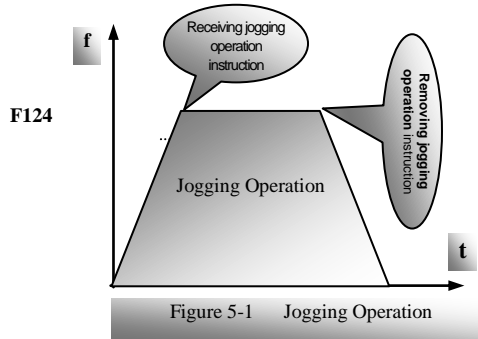

Figure 5-1 Jogging Operation

run to jogging frequency. The rated function codes are from F316 to F323.

- Jogging Acceleration Time: the time for inverter to accelerate from 0Hz to 50Hz.
- Jogging Deceleration Time: the time for inverter to decelerate from 50Hz to 0Hz.

F127/F129	Skip Frequency A,B (Hz)	Setting range: 0.00~590.0	Mfr's value:0.00
F128/F130	Skip Width A,B (Hz)	Setting range: 0.00~2.50	Mfr's value: 0.00

· When jogging function is valid, speed track function is invalid.

· Systematic vibration may occur when the motor is running at a certain frequency. This parameter is set to skip this frequency.

The inverter will skip the point automatically when output frequency is equal to the set value of this parameter.

“Skip Width” is the span from the upper to the lower limits around Skip Frequency. For example, Skip Frequency=20Hz, Skip Width=±0.5Hz, inverter will skip automatically when output is between 19.5~20.5Hz.

Inverter will not skip this frequency span during acceleration/deceleration.

Note: during the process of speed track, skip frequency function is invalid. After speed track is finished, this function is valid.

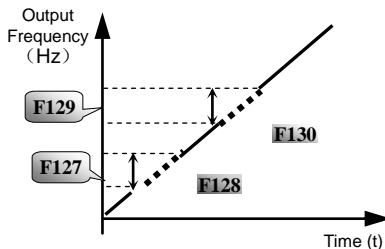

Figure 5-2 Skip Frequency

F131	Running Display Items	0—Current output frequency/function-code 1—Output rotary speed (RPM) 2—Output current (A) 4—Output voltage (V) 8—PN voltage (V) 16—PID feedback value (%) 32—Temperature (°C) 64—Reserved 128—Linear speed 256—PID given value (%) 2048—Output power (KW) 4096— Output torque (%)	Mfr's value: 0+1+2+4+8=15
------	-----------------------	--	------------------------------

· Inverter of 1-phase 0.75kw and below 0.75kW, 3-phase 230V 0.75kw and below 0.75Kw, 3-phase 400V 0.4kW and below 0.4kW have no the function of temperature display.

Selection of one value from 1, 2, 4, 8, 16, 32, 64 and 128 shows that only one specific display item is selected. Should multiple display items be intended, add the values of the corresponding display items and take the total values as the set value of F131, e.g., just set F131 to be 19 (1+2+16) if you want to call “current output rotary speed”, “output current” and “PID feedback value”. The other display items will be covered.

As F131=8191, all display items are visible, of which, “frequency/function-code” will be visible whether or not it is selected.

· Should you intend to check any display item, just press the “Fun” key for switchover.

Refer to the following table for each specific value unit and its indication:

Whatever the value of F131 is set to, corresponding target frequency will flash under stopped status.

Target rotary speed is an integral number. If it exceeds 9999, add a decimal point to it.

Current display A** Voltage display U*** Temperature H***

Linear speed L***. If it exceeds 999, add a decimal point to it. If it exceeds 9999, add two decimal points to it, and the like.

PID feedback value b** PID given value ** output power ** output torque **

F132	Display items of stop	Setting range: 0: Frequency/function-code 1: Keypad jogging 2: Target rotary speed (RPM) 4: PN voltage (V) 8: PID feedback value (%) 16: Temperature (°C) 32: Reserved 64: PID given value (%) 128: Reserved 256: Reserved 512: Setting torque (%)	Mfr's value: 0+2+4=6
F133	Drive ratio of driven system	Setting range: 0.10~200.0	Mfr's value: 1.00
F134	Transmission-wheel radius(M)	0.001~1.000	Mfr's value: 0.001

Calculation of rotary speed and linear speed:

For example, If inverter's max frequency F111=50.00Hz, numbers of motor poles F804=4, drive ratio F133=1.00, transmission-shaft radius R=0.05m, then

Transmission shaft perimeter: $2\pi r = 2 \times 3.14 \times 0.05 = 0.314$ (meter)

Transmission shaft rotary speed: $60 \times \text{operation frequency} / (\text{numbers of poles pairs} \times \text{drive ratio}) = 60 \times 50 / (2 \times 1.00) = 1500 \text{rpm}$

Endmost linear speed: rotary speed \times perimeter = $1500 \times 0.314 = 471$ (meters/second)

F136	Slip compensation	Setting range: 0~10	Mfr's value: 0
------	-------------------	---------------------	----------------

· Under V/F controlling, rotary speed of motor rotor will decrease as load increases. Be assured that rotor rotate speed is near to synchronization rotary speed while motor with rated load, slip compensation should be adopted according to the setting value of frequency compensation.

Note: during the process of speed track, slip compensation function is invalid. After speed track is finished, this function is valid.

F137	Modes of torque compensation	Setting range: 0: Linear compensation; 1: Square compensation; 2: User-defined multipoint compensation 3: Auto torque compensation	Mfr's value: 3
F138	Linear compensation	Setting range: 1~20	Mfr's value: Subject to inverter model
F139	Square compensation	Setting range: 1: 1.5 2: 1.8 3: 1.9 4: 2.0	Mfr's value: 1

To compensate low-frequency torque controlled by V/F, output voltage of inverter while low-frequency should be compensated.

When F137=0, linear compensation is chosen and it is applied on universal constant-torque load;

When F137=1, square compensation is chosen and it is applied on the loads of fan or water pump;

When F137=2, user-defined multipoint compensation is chosen and it is applied on the special loads of spin-drier or centrifuge; This parameter should be increased when the load is heavier, and this parameter should be decreased when the load is lighter.

If the torque is elevated too much, motor is easy to overheat, and the current of inverter will be too high. Please check the motor while elevating the torque.

When F137=3, auto torque compensation is chose and it can compensate low-frequency torque automatically, to diminish motor slip, to make rotor rotary speed close to synchro rotary speed and to restrain motor vibration. Customers should set correctly motor power, rotary speed, numbers of motor poles, motor rated current and stator resistance. Please refer to the chapter “Operation process of measuring motor stator resistance parameters”.

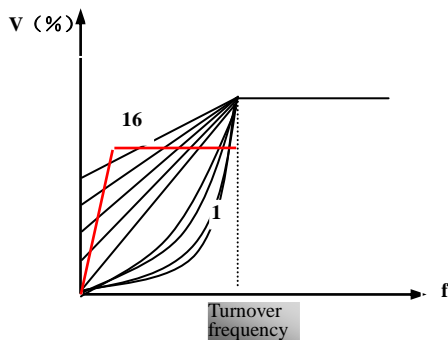

Fig 5-3 Torque Promotion

F140 Voltage compensation point frequency (Hz)	Setting range: 0.00~F142	Mfr's value: 1.00
F141 Voltage compensation point 1 (%)	Setting range: 0~30	Subject to inverter model
F142 User-defined frequency point F2	Setting range: F140~F144	Mfr's value: 5.00
F143 User-defined voltage point V2	Setting range: 0~100%	Mfr's value: 13
F144 User-defined frequency point F3	Setting range: F142~F146	Mfr's value: 10.00
F145 User-defined voltage point V3	Setting range: 0~100%	Mfr's value: 24
F146 User-defined frequency point F4	Setting range: F144~F148	Mfr's value: 20.00
F147 User-defined voltage point V4	Setting range: 0~100%	Mfr's value: 45
F148 User-defined frequency point F5	Setting range: F146~F150	Mfr's value: 30.00
F149 User-defined voltage point V5	Setting range: 0~100%	Mfr's value: 63
F150 User-defined frequency point F6	Setting range: F148~F118	Mfr's value: 40.00
F151 User-defined voltage point V6	Setting range: 0~100%	Mfr's value: 81

Multi-stage V/F curves are defined by 12 parameters from F140 to F151.

The setting value of V/F curve is set by motor load characteristic.

Note: $V_2 < V_3 < V_4 < V_5 < V_6$, $F_2 < F_3 < F_4 < F_5 < F_6$. As low-frequency, if the setting voltage is too high, motor will overheat or be damaged. Inverter will be stalling or occur over-current protection.

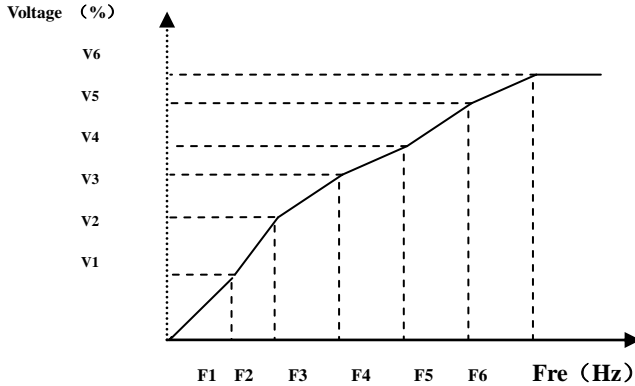

Fig 5-4 Polygonal-Line Type V/F

Note: during the process of speed track, polygonal-line V/F curve function is invalid. After speed track is finished, this function is valid.

F152 Output voltage corresponding to turnover frequency (%)	Setting range: 0~100	Mfr's value: 100
---	----------------------	------------------

This function can meet the needs of some special loads, for example, when the frequency outputs 300Hz and corresponding voltage outputs 200V (supposed voltage of inverter power supply is 400V), turnover frequency F118 should be set to 300Hz and F152 is set to $(200 \div 400) \times 100 = 50$. And F152 should be equal to the integer value 50.

Please note nameplate parameters of motor. If the working voltage is higher than rated voltage or the frequency is higher than rated frequency, motor would be damaged.

F153 Carrier frequency setting	Setting range: Subject to inverter model	Mfr's value: Subject to inverter model
--------------------------------	--	--

Carrier-wave frequency of inverter is adjusted by setting this code function. Adjusting carrier-wave may reduce motor noise, avoid point of resonance of mechanical system, decrease leakage current of wire to earth and the interference of inverter.

When carrier-wave frequency is low, although carrier-wave noise from motor will increase, the current leaked to the earth will decrease. The wastage of motor and the temperature of motor will increase, but the temperature of inverter will decrease.

When carrier-wave frequency is high, the situations are opposite, and the interference will rise.

When output frequency of inverter is adjusted to high frequency, the setting value of carrier-wave should be increased. Performance is influenced by adjusting carrier-wave frequency as below table:

Carrier-wave frequency	Low → High
Motor noise	Loud → Low
Waveform of output current	Bad → Good
Motor temperature	High → Low
Inverter temperature	Low → High
Leakage current	Low → High
Interference	Low → High

F154 Automatic voltage rectification	Setting range: 0: Invalid 1: Valid 2:Invalid during deceleration process	Mfr's value: 0
--------------------------------------	---	----------------

This function is enable to keep output voltage constant automatically in the case of fluctuation of input voltage, but the deceleration time will be affected by internal PI adjustor. If deceleration time is forbidden being changed, please select F154=2.

F155 Digital accessory frequency setting	Setting range: 0~F111	Mfr's value: 0
F156 Digital accessory frequency polarity setting	Setting range: 0 ~ 1	Mfr's value: 0
F157 Reading accessory frequency		
F158 Reading accessory frequency polarity		

Under combined speed control mode, when accessory frequency source is digital setting memory (F204=0), F155 and F156 are considered as initial set values of accessory frequency and polarity (direction).

In the mode of combined speed control, F157 and F158 are used for reading the value and direction of accessory frequency.

For example, when F203=1, F204=0, F207=1, the given analog frequency is 15Hz, inverter is required to run to 20Hz. In case of this requirement, user can push "UP" button to raise the frequency from 15Hz to 20Hz. User can also set F155=5Hz and F156=0 (0 means forward, 1 means reverse). In this way, inverter can be run to 20Hz directly.

F159 Random carrier-wave selection	Setting range: 0: Invalid 1: Valid	Mfr's value: 1
------------------------------------	------------------------------------	----------------

When F159=0, inverter will modulate as per the carrier-wave set by F153. When F159=1, inverter will operate in mode of random carrier-wave modulating.

Note: when random carrier-wave is selected, output torque will increase but noise will be loud. When the carrier-wave set by F153 is selected, noise will be reduced, but output torque will decrease. Please set the value according to the situation.

F160 Recover factory parameters	Setting range: 0: Invalid 1: Valid	Mfr's value: 0
---------------------------------	------------------------------------	----------------

When there is disorder with inverter's parameters and manufacturer values need to be restored, set F160=1. After "Reverting to manufacturer values" is done, F160 values will be automatically changed to 0.

"Reverting to manufacturer values" will not work for the function-codes marked "o" in the "change" column of the parameters table. These function codes have been adjusted properly before delivery. And it is recommended not to change them.

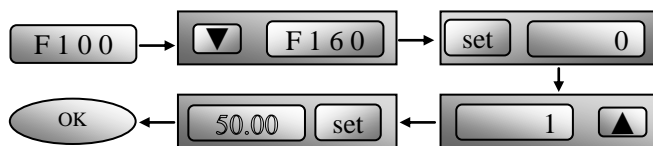

Figure 5-3 Reverting to manufacturer values

5.2 Operation Control

F200 Source of start command	Setting range: 0: Keypad command; 1: Terminal command; 2: Keypad+Terminal; 3: MODBUS; 4: Keypad+Terminal+MODBUS	Mfr's value: 4
F201 Source of stop command	Setting range: 0: Keypad command; 1: Terminal command; 2: Keypad+Terminal; 3: MODBUS; 4: Keypad+Terminal+MODBUS	Mfr's value: 4

·F200 and F201 are the resource of selecting inverter control commands.

·Inverter control commands include: starting, stopping, forward running, reverse running, jogging, etc.

·"Keypad command" refers to the start/stop commands given by the "Run" or "stop/reset" key on the keypad.

·"Terminal command" refers to the start/stop command given by the "Run" terminal defined by F316-F323.

When F200=3 and F201=3, the running command is given by MODBUS communication.

When F200=2 and F201=2, "keypad command" and "terminal command" are valid at the mean time, F200=4 and F201=4 are the same.

F202 Mode of direction setting	Setting range: 0: Forward running locking; 1: Reverse running locking; 2: Terminal setting	Mfr's value: 0
-----------------------------------	---	----------------

·The running direction is controlled by this function code together with other speed control mode which can set the running direction of inverter. When auto-circulation speed is selected by F500=2, this function code is not valid. When F208≠0, this function is invalid.

·When speed control mode without controlling direction is selected, the running direction of inverter is controlled by this function code, for example, keypad controls speed.

·When speed control mode with controlling direction is selected, the running direction of inverter is controlled by both modes. Please refer to the following table:

Direction given by F202	Direction given by other speed control mode	Running direction	Remarks
0	0	0	0 stands for forward running. 1 stands for reverse running.
0	1	1	
1	0	1	
1	1	0	

F203 Main frequency source X	Setting range: 0: Memory of digital given; 1: External analog AI1; 2: External analog AI2; 3: Reserved; 4: Stage speed control; 5: No memory of digital given; 6: Analog AI3; 7: Reserved; 8: Reserved 9: PID adjusting; 10: MODBUS	Mfr's value: 0
---------------------------------	--	----------------

·Main frequency source is set by this function code.

0: Memory of digital given

Its initial value is the value of F113. The frequency can be adjusted through the key “up” or “down”, or through the “up”, “down” terminals.

“Memory of digital given” means after inverter stops, the target frequency is the running frequency before stop. If the user would like to save target frequency in memory when the power is disconnected, please set F220=1, i.e. frequency memory after power-down is valid.

1: External analog AI1; 2: External analog AI2

The frequency is set by analog input terminal AI1 and AI2. The analog signal may be current signal (0-20mA or 4-20mA) or voltage signal (0-5V or 0-10V), which can be chosen by switch code. Please adjust the switch code according to practical situations, refer to fig 4-4, 4-5 and table 4-2, 4-3.

When inverters leave the factory, the analog signal of AI1 channel is DC voltage signal, the range of voltage is 0-10V, and the analog signal of AI2 channel is DC current signal, the range of current is 0-20 mA. If 4-20mA current signal is needed, please set lower limit of analog input F406=2, which input resistor is 500OHM. If some errors exist, please make some adjustments.

4: Stage speed control

Multi-stage speed control is selected by setting stage speed terminals F316-F322 and function codes of multi-stage speed section. The frequency is set by multi-stage terminal or automatic cycling frequency.

5: No memory of digital given

Its initial value is the value of F113. The frequency can be adjusted through the key “up” or “down”, or through the “up”, “down” terminals.

“No memory of digital given” means that the target frequency will restore to the value of F113 after stop no matter the state of F220.

6: Analog AI3

The frequency is set by the potentiometer on the control panel. . F422 should be set to 1.

9: PID adjusting

When PID adjusting is selected, the running frequency of inverter is the value of frequency adjusted by PID. Please refer to instructions of PID parameters for PID given resource, PID given numbers, feedback source, and so on.

10: MODBUS

The main frequency is given by MODBUS communication.

F204 Accessorial frequency source Y	Setting range:	Mfr's value: 0
	0: Memory of digital given; 1: External analog AI1; 2: External analog AI2; 3: Reserved; 4: Stage speed control; 5: PID adjusting; 6: Analog AI3	

·When accessorial frequency Y is given to channel as independent frequency, it has the same function with main frequency source X.

·When F204=0, the initial value of accessorial frequency is set by F155. When accessorial frequency controls speed independently, polarity setting F156 is not valid.

·When F207=1, and F204=0, the initial value of accessorial frequency is set by F155, the polarity of accessorial frequency is set by F156, the initial value of accessorial frequency and the polarity of accessorial frequency can be checked by F157 and F158.

·When the accessorial frequency is given by analog input (AI1, AI2), the setting range for the accessorial frequency is set by F205 and F206.

When the accessorial frequency is given by keypad potentiometer, the main frequency can only select stage speed control and modbus control (F203=4, 10)

· Note: accessorial frequency source Y and main frequency source X cannot be same, i.e., they cannot use the same frequency given channel.

F205 Reference for selecting accessorial frequency source Y range	Setting range: 0: Relative to max frequency; 1: Relative to frequency X	Mfr's value: 0
F206 Accessorial frequency Y range (%)	Setting range: 0~100	Mfr's value: 100

· When combined speed control is adopted for frequency source, F206 is used to confirm the relative object of the setting range for the accessorial frequency.

F205 is to confirm the reference of the accessorial frequency range. If it is relative to main frequency, the range will change according to the change of main frequency X.

F207 Frequency source selecting	Setting range: 0: X; 1: X+Y; 2: X or Y (terminal switchover); 3: X or X+Y (terminal switchover); 4: Combination of stage speed and analog 5: X-Y 6: $X+Y-Y_{MAX} * 50\%$	Mfr's value: 0
---------------------------------	---	----------------

Select the channel of setting the frequency. The frequency is given by combination of main frequency X and accessorial frequency Y.

· When F207=0, the frequency is set by main frequency source.

· When F207=1, X+Y, the frequency is set by adding main frequency source to accessorial frequency source. X or Y can be given by PID.

· When F207=2, main frequency source and accessorial frequency source can be switched over by frequency source switching terminal.

· When F207=3, main frequency given and adding frequency given(X+Y) can be switched over by frequency source switching terminal. X or Y cannot be given by PID.

· When F207=4, stage speed setting of main frequency source has priority over analog setting of accessorial frequency source (only suitable for F203=4 F204=1).

· When F207=5, X-Y, the frequency is set by subtracting accessorial frequency source from main frequency source. If the frequency is set by main frequency or accessorial frequency, PID speed control cannot be selected.

· When F207=6, $X+Y-Y_{MAX} * 50\%$, the frequency is given by both main frequency source and accessorial frequency source. X or Y cannot be given by PID. When F205=0, $Y_{MAX}=F111 * F206$. When F205=1, $Y_{MAX}=X * F206$.

Note:

1. When F203=4 and F204=1, the difference between F207=1 and F207=4 is that when F207=1, frequency source selecting is the addition of stage speed and analog, when F207=4, frequency source selecting is stage speed with stage speed and analog given at the same time. If stage speed given is canceled and analog given still exists, inverter will run by analog given.
2. Frequency given mode can be switched over by selecting F207. For example: switching PID adjusting and normal speed control, switching stage speed and analog given, switching PID adjusting and analog given, and so on.
3. The acceleration/deceleration time of stage speed is set by function code of corresponding stage speed time. When combined speed control is adopted for frequency source, the acceleration/deceleration time is set by F114 and F115.

4. When stage speed control is valid, the accel/decel time of stage speed is executed firstly. After inverter is powered on and stage speed control is invalid, the time of F114 and F115 is executed. If stage speed signal is cancelled in the process of running, the accel/decel time of stage speed is also valid.
5. The mode of automatic cycle speed control is unable to combine with other modes.
6. When F207=2 (main frequency source and accessorial frequency source can be switched over by terminals), if main frequency is not set to be under stage-speed control, accessorial frequency can be set to be under automatic cycle speed control (F204=4, F500=2). Through the defined switchover terminal, the control mode (defined by X) and automatic cycle speed control (defined by Y) can be freely switched.
7. If the settings of main frequency and accessorial frequency are the same, only main frequency will be valid.
8. When F207=6, F205=0 and F206=100, $X+Y \cdot Y_{MAX} * 50\% = X+Y \cdot F111 * 50\%$, and if F207=6, F205=1 and F206=100, then $X+Y \cdot Y_{MAX} * 50\% = X+Y \cdot X * 50\%$.

F208 Terminal two-line/three-line operation control	Setting range: 0: No function; 1: Two-line operation mode 1; 2: Two-line operation mode 2; 3: three-line operation mode 1; 4: three-line operation mode 2; 5: start/stop controlled by direction pulse	Mfr's value: 0
--	--	----------------

·When selecting two-line type or three-line type, F200, F201 and F202 are invalid.

·Five modes are available for terminal operation control.

Note:

In case of stage speed control, set F208 to 0. If F208 \neq 0 (when selecting two-line type or three-line type), F200, F201 and F202 are invalid.

“FWD”, “REV” and “X” are three terminals designated in programming DI1 ~ DI5.

1: Two-line operation mode 1: this mode is the most popularly used two-line mode. The running direction of mode is controlled by FWD, REV terminals.

For example: “FWD” terminal-----“open”: stop, “closed”: forward running;

“REV” terminal-----“open”: stop, “closed”: reverse running;

“CM” terminal-----common port

K1	K2	Running command
0	0	Stop
1	0	Forward running
0	1	Reverse running
1	1	Stop

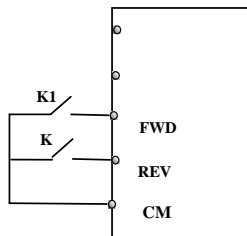

2. Two-line operation mode 2: when this mode is used, FWD is enable terminal, the direction is controlled by REV terminal.

For example: “FWD” terminal-----“open”: stop, “closed”: running;

“REV” terminal-----“open”: forward running, “closed”: reverse running;

“CM” terminal-----common port

K1	K2	Running command
0	0	Stop
0	1	Stop
1	0	Forward running
1	1	Reverse running

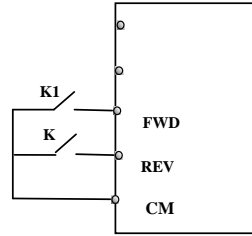

3. Three-line operation mode 1:

In this mode, X terminal is enable terminal, the direction is controlled by FWD terminal and REV terminal. Pulse signal is valid. Stopping command is enable by opening X terminal.

SB3: stop button

SB2: forward button

SB1: reverse button

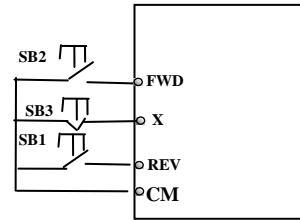

4. Three-line operation mode 2:

In this mode, X terminal is enable terminal, running command is controlled by FWD terminal. The running direction is controlled by REV terminal, and stopping command is enable by opening X terminal.

SB1: Running button

SB2: Stop button

K1: direction switch. Open stands for forward running; close stands for reverse running.

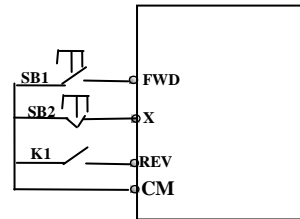

5. Start/stop controlled by direction pulse:

“FWD” terminal—(impulse signal: forward/stop)

“REV” terminal—(impulse signal: reverse/stop)

“CM” terminal—common port

Note: when pulse of SB1 triggers, inverter will run forward. When the pulse triggers again, inverter will stop running.

When pulse of SB2 triggers, inverter will run reverse. When the pulse triggers again, inverter will stop running.

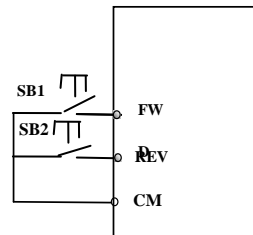

F209	Selecting the mode of stopping the motor	Setting range: 0: stop by deceleration time; 1: free stop	Mfr's value: 0
------	--	--	----------------

When the stop signal is input, stopping mode is set by this function code:

F209=0: stop by deceleration time

Inverter will decrease output frequency according to setting acceleration/deceleration curve and decelerating time, after frequency decreases to 0, inverter will stop. This is common used stopping type.

F209=1: free stop

After stop command is valid, inverter will stop output. Motor will free stop by mechanical inertia.

F210 Frequency display accuracy	Setting range: 0.01~2.00	Mfr's value: 0.01
---------------------------------	--------------------------	-------------------

When inverter is running or RUN light is sparkling, under keypad speed control or terminal UP/DOWN speed control, frequency display accuracy is set by this function code and the range is from 0.01 to 10.00. For example, when F210=0.5, UP/DOWN terminal is pressed at one time, frequency will increase or decrease by 0.5Hz.

When the setpoint is digital given, UP/DOWN terminal can adjust the speed at any time. The accuracy is set by F210.

F211 Speed of digital control (Hz/s)	Setting range: 0.01~100.0	Mfr's value: 5.00
--------------------------------------	---------------------------	-------------------

When UP/DOWN terminal is pressed, frequency will change at the setting rate. The Mfr's value is 5.00Hz/s. F211=50Hz/F114. For example, if F114=5.0, F211=50Hz/5s=10(Hz/s).

F212 Direction memory	Setting range: 0: Invalid 1: Valid	Mfr's value: 0
-----------------------	------------------------------------	----------------

· This function is valid when three-line operation mode 1 (F208=3) is valid.

· When F212=0, after inverter is stopped, resetted and repowered on, the running direction is not memorized.

· When F212=1, after inverter is stopped, resetted and repowered on, if inverter starts running but no direction signal, inverter will run according the memory direction.

F213 Auto-starting after repowered on	Setting range: 0: invalid; 1: valid	Mfr's value: 0
---------------------------------------	-------------------------------------	----------------

F214 Auto-starting after reset	Setting range: 0: invalid; 1: valid	Mfr's value: 0
--------------------------------	-------------------------------------	----------------

Whether or not to start automatically after repowered on is set by F213

F213=1, auto-starting after repowered on is valid. When inverter is power off and then powered on again, it will run automatically after the time set by F215 and according to the running mode before power-down. If F220=0 frequency memory after power-down is not valid, inverter will run by the setting value of F113.

F213=0, after repower-on, inverter will not run automatically unless running command is given to inverter.

Whether or not to start automatically after fault resetting is set by F214

When F214=1, if fault occurs, inverter will reset automatically after delay time for fault reset (F217). After resetting, inverter will run automatically after the auto-starting delay time (F215).

If frequency memory after power-down (F220) is valid, inverter will run at the speed before power-down. Otherwise, inverter will run at the speed set by F113.

In case of fault under running status, inverter will reset automatically and auto-start. In case of fault under stopped status, the inverter will only reset automatically.

When F214=0, after fault occurs, inverter will display fault code, it must be reset manually.

F215 Auto-starting delay time	Setting range: 0.1~3000.0	Mfr's value: 60.0
-------------------------------	---------------------------	-------------------

F215 is the auto-starting delay time for F213 and F214. The range is from 0.1s to 3000.0s.

F216 Times of auto-starting in case of repeated faults	Setting range: 0~5	Mfr's value: 0
--	--------------------	----------------

F217 Delay time for fault reset	Setting range: 0.0~10.0	Mfr's value: 3.0
---------------------------------	-------------------------	------------------

F219 EEPROM write operation	Setting range: 0: enabled to write 1: only RAM	Mfr's value: 1
-----------------------------	--	----------------

F216 sets the most times of auto-starting in case of repeated faults. If starting times are more than the setting value of this function code, inverter will not reset or start automatically after fault. Inverter will run after running command is given to inverter manually.

F217 sets delay time for fault reset. The range is from 0.0 to 10.0S which is time interval from fault to resetting.

When F219=1 (address 2001H is not operated by PC/PLC), the function code is modified by communication, and it is not saved in the EEPROM. It means there is no memory when power down. When F219=0 (address 2001H is not operated by PC/PLC), the function code is modified by communication, and it is saved in the

EEPORM. It means there is memory when power down.

F220	Frequency memory after power-down	Setting range: 0: invalid; 1: valid	Mfr's value: 0
------	-----------------------------------	-------------------------------------	----------------

F220 sets whether or not frequency memory after power-down is valid.

This function is valid for F213 and F214. Whether or not to memory running state after power-down or malfunction is set by this function.

The function of frequency memory after power-down is valid for main frequency and accessorial frequency that is given by digital. Because the accessorial frequency of digital given has positive polarity and negative polarity, it is saved in the function codes F155 and F156.

Table 5-1 Combination of Speed Control

F203 \ F204	0. Memory of digital setting	1 External analog AI1	2 External analog AI2	4 Terminal stage speed control	5 PID adjusting	6 Keypad potentiometer AI3
0 Memory of Digital setting	○	●	●	●	●	○
1 External analog AI1	●	○	●	●	●	○
2 External analog AI2	●	●	○	●	●	○
4 Terminal Stage speed control	●	●	●	○	●	●
5 Digital setting	○	●	●	●	●	○
6 Keypad potentiometer AI3	●	●	●	●	●	○
9 PID adjusting	●	●	●	●	○	○
10 MODBUS	●	●	●	●	●	●

●: Inter-combination is allowable.

○: Combination is not allowable.

The mode of automatic cycle speed control is unable to combine with other modes. If the combination includes the mode of automatic cycle speed control, only main speed control mode will be valid.

ill output a signal.

F224 when target frequency is lower than Min frequency	Setting range: 0: stop 1: run at min frequency	Mfr's value: 0
--	---	----------------

·F224=0, when target frequency is lower than Min frequency, inverter will stop.

·F224=1, when target frequency is lower than Min frequency, inverter will run at Min frequency.

F226 Action of skipping frequency	Setting range: 0: no action during accelerating 1: no action during decelerating 2. valid at any time	Mfr's value: 0
-----------------------------------	--	----------------

·F226=0, inverter will not skip the F127/F129 during accelerating.

F226=1, inverter will not skip F127/129 during decelerating. It only works during running with stable speed or acceleration.

F226=2, it works at accelerating, decelerating and running with stable speed.

5.3. Multifunctional Input and Output Terminals

5.3.1 Digital multifunctional output terminals

F300	Relay token output	Setting range: 0~40	Mfr's value: 1
F301	DO1 token output		Mfr's value: 14
F302	DO2 token output	Refer to table 5-2 for detailed instructions.	Mfr's value: 5

E800 inverter has one multifunctional relay output terminal. Inverters of 30kW and below 30kW have one multifunctional digital output terminals (without DO2 terminal).

Table 5-2 Instructions for digital multifunctional output terminal

Value	Function	Instructions
0	no function	Output terminal has no functions.
1	inverter fault protection	When inverter works wrong, ON signal is output.
2	over latent frequency 1	Please refer to instructions from F307 to F309.
3	over latent frequency 2	Please refer to instructions from F307 to F309.
4	free stop	Under free stop status, after stop command is given, ON signal is output until inverter completely stops.
5	in running status 1	Indicating that inverter is running and ON signal is output.
6	DC braking	Indicating that inverter is in the status of DC braking and ON signal is output.(the function is invalid for 30kw and above 30kw)
7	acceleration/deceleration time switchover	Indicating that inverter is in the status of acceleration/deceleration time switchover
8	Reserved	
9	Reserved	
10	inverter overload pre-alarm	After inverter overloads, ON signal is output after the half time of protection timed, ON signal stops outputting after overload stops or overload protection occurs.
11	motor overload pre-alarm	After motor overloads, ON signal is output after the half time of protection timed, ON signal stops outputting after overload stops or overload protection occurs.
12	stalling	During accel/decel process, inverter stops accelerating/decelerating because inverter is stalling, and ON signal is output.
13	Inverter is ready to run	When inverter is powered on. Protection function is not in action and inverter is ready to run, then ON signal is output.
14	In running status 2	Indicating that inverter is running and ON signal is output. When inverter is running at 0HZ, it seems as the running status, and ON signal is output.
15	frequency arrival output	Indicating inverter runs to the setting target frequency, and ON signal is output. See F312.
16	overheat pre-alarm	When testing temperature reaches 80% of setting value, ON signal is output. When overheat protection occurs or testing value is lower than 80%of setting value, ON signal stops outputting.
17	over latent current output	When output current of inverter reaches the setting overlatent current, ON signal is output. See F310 and F311.
18	Analog line disconnection	Indicating inverter detects analog input lines disconnection, and ON signal is output. Please refer to F741.

	protection	
19	Under-load 1 pre-alarm	Please refer to FA26 and FA27.
20	Zero current detecting output	When inverter output current has fallen to zero current detecting value, and after the setting time of F755, ON signal is output. Please refer to F754 and F755.
21	DO1 Output controlled by PC/PLC	1 means output is valid. 0 means output is invalid.
22	DO2 Output controlled by PC/PLC	
23	TA\TC Output controlled by PC/PLC	
24	Watchdog output token	The token output is valid when inverter trips into Err6.
25-29	Reserved	
30	General pump is running	Indicating some general pumps are running.
31	Converter pump is running	Indicating some converter pumps are running.
32	Over-limit pressure token	Indicating the max limit value when PID adjusting is valid and negative feedback is selected, and feedback pressure is higher than max pressure set by FA03

F304	S curve beginning stage proportion (%)	Setting range: 2.0~50.0	30.0
F305	S curve ending stage proportion (%)	Setting range: 2.0~50.0	30.0
F306	Accel/decel mode	Setting range: 0: Straight-line 1: S curve	0

Please refer to Fig 5-9 about S curve accel/decel:

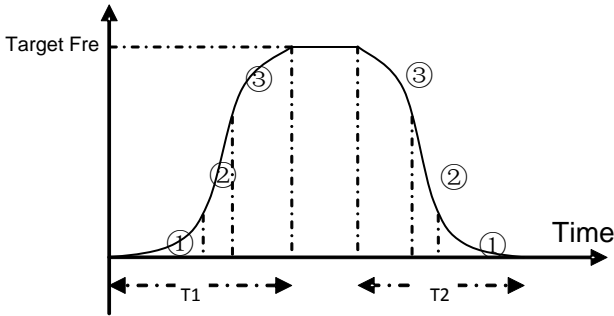

Fig 5-9 S curve acceleration /deceleration

T1 is the acceleration time from present frequency to target frequency.

T2 is the deceleration time from present frequency to target frequency.

During the acceleration process, in the ① stage, the acceleration slope is bigger gradually, in the ② stage, the acceleration slope is constant, in the ③ stage, the acceleration slope is weaker gradually.

F307	Characteristic frequency 1 (Hz)	Setting range: F112~F111	Mfr's value: 10.00
F308	Characteristic frequency 2 (Hz)		Mfr's value: 50.00

F309 Characteristic frequency width (%)	Setting range: 0~100	Mfr's value: 50
---	----------------------	-----------------

When F300 and F301=2,3 and token characteristic frequency is selected, this group function codes set characteristic frequency and its width.

For example: setting F301=2, F307=10, F309=10, when running frequency is greater than or equal to F307, DO1 will be in action. When running frequency is lower than $(10-10*10\%)=9\text{Hz}$, DO1 will be disconnected.

F310 Characteristic current (A)	Setting range: 0~5000.0	Mfr's value: Rated current
---------------------------------	-------------------------	----------------------------

F311 Characteristic current width (%)	Setting range: 0~100	Mfr's value: 10
---------------------------------------	----------------------	-----------------

When F300 and F302=17 and token characteristic current is selected, this group function codes set characteristic current and its width.

For example: setting F301=17, F310=100, F311=10, when current of inverter is greater than or equal to F310, DO1 will be in action. When inverter current is lower than $(100-100*10\%)=90\text{A}$, DO1 will be disconnected.

F312 Frequency arrival threshold (Hz)	Setting range: 0.00~5.00	Mfr's value: 0.00
---------------------------------------	--------------------------	-------------------

When F300=15 and F301=15, threshold range is set by F312.

For example: when F301=15, target frequency is 20HZ and F312=2, the running frequency reaches 18Hz (20-2), ON signal is output by DO1 until the running frequency reaches target frequency.

5.3.2 Digital multifunctional input terminals

F316 DI1 terminal function setting	Setting range: 0: no function; 1: running terminal; 2: stop terminal;	Mfr's value: 11
F317 DI2 terminal function setting	3: multi-stage speed terminal 1; 4: multi-stage speed terminal 2; 5: multi-stage speed terminal 3;	Mfr's value: 9
F318 DI3 terminal function setting	6: multi-stage speed terminal 4; 7: reset terminal;	Mfr's value: 15
F319 DI4 terminal function setting	8: free stop terminal; 9: external emergency stop terminal; 10: acceleration/deceleration forbidden terminal;	Mfr's value: 16
F320 DI5 terminal function setting	11: forward run jogging; 12: reverse run jogging; 13: UP frequency increasing terminal; 14: DOWN frequency decreasing terminal;	Mfr's value: 7
F321 DI6 terminal function setting	15: "FWD" terminal; 16: "REV" terminal; 17: three-line type input "X" terminal;	Mfr's value: 8
F322 DI7 terminal function setting	18: acceleration/deceleration time switchover 1; 19: Reserved; 20: Speed/torque switchover	Mfr's value: 0

F323 DI8 terminal function setting	21: frequency source switchover terminal; 30: Water lack signal; 31: Signal of water 32: Fire pressure switchover; 33: Emergency fire control 34: Acceleration / deceleration switchover 2 37: Common-open PTC heat protection 38: Common-close PTC heat protection 53: Watchdog 54: Frequency reset 61: Start-stop terminal	Mfr's value: 2
------------------------------------	--	----------------

This parameter is used for setting the corresponding function for multifunctional digital input terminal.

Both free stop and external emergency stop of the terminal have the highest priority.

Table 5-3 Instructions for digital multifunctional input terminal

Value	Function	Instructions
0	No function	Even if signal is input, inverter will not work. This function can be set by undefined terminal to prevent mistake action.
1	Running terminal	When running command is given by terminal or terminals combination and this terminal is valid, inverter will run. This terminal has the same function with "run" key in keypad.
2	Stop terminal	When stop command is given by terminal or terminals combination and this terminal is valid, inverter will stop. This terminal has the same function with "stop" key in keypad.
3	Multistage speed terminal 1	15-stage speed is realized by combination of this group of terminals. See table 5-4.
4	Multistage speed terminal 2	
5	Multistage speed terminal 3	
6	Multistage speed terminal 4	
7	Reset terminal	This terminal has the same function with "reset" key in keypad. Long-distance malfunction reset can be realized by this function.
8	Free stop terminal	Inverter closes off output and motor stop process is not controlled by inverter. This mode is often used when load has big inertia or there are no requirements for stop time. This mode has the same function with free stop of F209.
9	External emergency stop terminal	When external malfunction signal is given to inverter, malfunction will occur and inverter will stop.
10	Acceleration/deceleration forbidden terminal	Inverter will not be controlled by external signal (except for stop command), and it will run at the current output frequency.
11	forward run jogging	Forward jogging running and reverse jogging running. Refer to F124, F125 and F126 for jogging running frequency, jogging acceleration/deceleration time.
12	reverse run jogging	
13	UP frequency increasing terminal	When frequency source is set by digital given, the setting frequency can be adjusted which rate is set by F211.
14	DOWN frequency decreasing terminal	
15	"FWD" terminal	When start/stop command is given by terminal or terminals combination, running direction of inverter is controlled by external terminals.
16	"REV" terminal	

17	Three-line input “X” terminal	“FWD”, “REV”, “CM” terminals realize three-line control. See F208 for details.
18	acceleration/deceleration time switchover 1	Please refer to Table 5-4.
21	frequency source switchover terminal	When F207=2, main frequency source(X) and accessorial frequency source(Y) can be switched over by frequency source switching terminal. When F207=3, X and (X + Y) can be switched over by frequency source switching terminal.
30	Water lack signal	When PID control is valid and FA26=1, this function is valid. While lack of water, inverter will be in the protection state.
31	Signal of water	When PID control is valid and FA26=1, this function is valid. If water is enough, inverter will reset automatically.
32	Fire pressure switchover	When PID control is valid and this terminal is valid, the setting value of PID switches into fire pressure given (FA58).
33	Emergency fire control	When emergency fire mode (FA59) is valid, inverter will be in emergency fire mode.
34	Acceleration / deceleration switchover 2	Please refer to Table 5-4.
37	Common-open PTC heat protection	When this function is valid, common-open heat relay is externally connected. When common-open contact is closed and inverter is in the running status, inverter will trip into OH1.
38	Common-close PTC heat protection	When this function is valid, common-close heat relay is externally connected. When common-close contact is open and inverter is in the running status, inverter will trip into OH1.
53	Watchdog	During the time set by F326 elapses without an impulse being registered, inverter will trip into Err6, and inverter will stop according to stop mode set by F327.
54	Frequency reset	In the application 4, if the function is valid, target frequency will change to the value set by F113.
61	Start-stop terminal	When the function is invalid, it is stop terminal. When the function is valid, it is start terminal. This function is limited by F200 and F201.

Table 5-4 Accel/decel selection

Accel/decel switchover 2 (34)	Accel/decel switchover 1 (18)	Present accel/decel time	Related parameters
0	0	The first accel/decel time	F114, F115
0	1	The second accel/decel time	F116, F117
1	0	The third accel/decel time	F277, F278
1	1	The fourth accel/decel time	F279, F280

Table 5-5 Instructions for multistage speed

K4	K3	K2	K1	Frequency setting	Parameters
0	0	0	0	None	None
0	0	0	1	Multi-stage speed 1	F504/F519/F534/F549/F557/F565
0	0	1	0	Multi-stage speed 2	F505/F520/F535/F550/F558/F566
0	0	1	1	Multi-stage speed 3	F506/F521/F536/F551/F559/F567

0	1	0	0	Multi-stage speed 4	F507/F522/F537/F552/F560/F568
0	1	0	1	Multi-stage speed 5	F508/F523/F538/F553/F561/F569
0	1	1	0	Multi-stage speed 6	F509/F524/F539/F554/F562/F570
0	1	1	1	Multi-stage speed 7	F510/F525/F540/F555/F563/F571
1	0	0	0	Multi-stage speed 8	F511/F526/F541/F556/F564/F572
1	0	0	1	Multi-stage speed 9	F512/F527/F542/F573
1	0	1	0	Multi-stage speed 10	F513/F528/F543/F574
1	0	1	1	Multi-stage speed 11	F514/F529/F544/F575
1	1	0	0	Multi-stage speed 12	F515/F530/F545/F576
1	1	0	1	Multi-stage speed 13	F516/F531/F546/F577
1	1	1	0	Multi-stage speed 14	F517/F532/F547/F578
1	1	1	1	Multi-stage speed 15	F518/F533/F548/F579

Note: K4 is multi-stage speed terminal 4, K3 is multi-stage speed terminal 3, K2 is multi-stage speed terminal 2, K1 is multi-stage speed terminal 1. And 0 stands for OFF, 1 stands for ON.

F324 Free stop terminal logic	Setting range: 0: positive logic (valid for low level); 1: negative logic (valid for high level)	Mfr's value: 0
F325 External emergency stop terminal logic		Mfr's value: 0
F326 Watchdog time	Setting range: 0.0: Invalid 0.1~3000	Mfr's value: 10.0
F327 Stop mode	Setting range: 0: Free to stop 1: Deceleration to stop	Mfr's value : 0
F328 Terminal filtering times	Setting range: 1~100	Mfr's value: 20

When multi-stage speed terminal is set to free stop terminal (8) or external emergency stop terminal (9), logic level is set by this group of function codes. When F324=0 and F325=0, positive logic and low level is valid, when F324=1 and F325=1, negative logic and high level is valid.

When F326=0.0, watchdog function is invalid.

When F327=0, and during the time set by F326 elapses without an impulse being registered, inverter will free to stop and it will trip into Err6, and digital output token is valid.

When F327=1, and during the time set by F326 elapses without an impulse being registered, inverter will deceleration to stop, then inverter will trip into Err6, and digital output token is valid.

Diagnostics and simulation functions

F330 Diagnostics of DIX terminal	Read only
----------------------------------	-----------

F330 is used to display the diagnostics of DIX terminals.

Please refer to Fig 5-11 about the DIX terminals diagnostics in the first digitron.

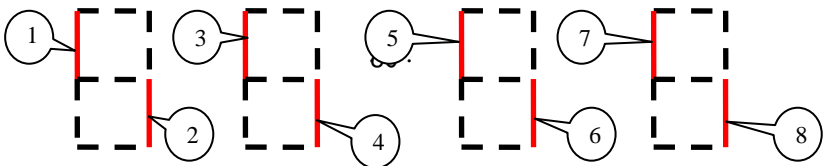

Fig 5-11 Status of digital input terminal

The dotted line means this part of digitron is red.

For example, in the first digitron, the upper part of digitron is red, it means DI1 terminal is invalid. The lower part of digitron is red, it means DI2 is valid. The four digitrons stands for the status of DI1-DI8 terminals

Analog input monitoring

F331 Monitoring AI1		Read only
F332 Monitoring AI2		Read only
F333 Monitoring AI3		Read only

The value of analog is displayed by 0~4095.

Relay/Digital output simulation

F335	Relay output simulation	Setting range: 0: Output active 1: Output inactive.	Mfr's value: 0
F336	DO1 output simulation		Mfr's value: 0
F337	DO2 output simulation		Mfr's value: 0

Take an example of DO1 output simulation, when inverter is in the stop status and enter F336, press the UP key, the DO1 terminal is valid. Relax the UP key, DO1 remains valid status. After quitting F336, DO1 will revert to initial output status.

Analog output simulation

F338	AO1 output simulation	Setting range: 0~4095	Mfr's value: 0
F339	AO2 output simulation	Setting range: 0~4095	Mfr's value: 0

When inverter is in the stop status, and enter F338 or F339, press the UP key, the output analog will increase, and when press the DOWN key, the output analog will decrease. If relax the key, analog output remains stable. After quitting the parameters, AO1 and AO2 will revert to initial output status.

F340 Selection of terminal negative logic	Setting range: 0: Invalid 1: DI1 negative logic 2: DI2 negative logic 4: DI3 negative logic 8: DI4 negative logic 16: DI5 negative logic 32: DI6 negative logic 64: DI6 negative logic 128: DI8 negative logic	Mfr's value: 0
---	--	----------------

For example: if user wants to set DI1 and DI4 to negative logic, please set F340=1+8=9.

F343	Delay time of DI1 ON	Setting range: 0.00~99.99	Mfr's value: 0.00
F344	Delay time of DI2 ON	Setting range: 0.00~99.99	Mfr's value: 0.00
F345	Delay time of DI3 ON	Setting range: 0.00~99.99	Mfr's value: 0.00
F346	Delay time of DI4 ON	Setting range: 0.00~99.99	Mfr's value: 0.00
F347	Delay time of DI5 ON	Setting range: 0.00~99.99	Mfr's value: 0.00
F348	Delay time of DI6 ON	Setting range: 0.00~99.99	Mfr's value: 0.00
F351	Delay time of DI1 OFF	Setting range: 0.00~99.99	Mfr's value: 0.00

F352	Delay time of DI2 OFF	Setting range: 0.00~99.99	Mfr's value: 0.00
F353	Delay time of DI3 OFF	Setting range: 0.00~99.99	Mfr's value: 0.00
F354	Delay time of DI4 OFF	Setting range: 0.00~99.99	Mfr's value: 0.00
F355	Delay time of DI5 OFF	Setting range: 0.00~99.99	Mfr's value: 0.00
F356	Delay time of DI6 OFF	Setting range: 0.00~99.99	Mfr's value: 0.00

5.4 Analog Input and Output

E800 series inverters have 2 analog input channels and 2 analog output channels.

F400	Lower limit of AI1 channel input	Setting range: 0.00~F402	Mfr's value: 0.04
F401	Corresponding setting for lower limit of AI1 input	Setting range: 0~F403	Mfr's value: 1.00
F402	Upper limit of AI1 channel input	Setting range: F400~10.00V	Mfr's value: 10.00
F403	Corresponding setting for upper limit of AI1 input	Setting range: Max (1.00, F401) ~2.00	Mfr's value: 2.00
F404	AI1 channel proportional gain K1	Setting range: 0.0~10.0	Mfr's value: 1.0
F405	AI1 filtering time constant	Setting range: 0.1~10.00	Mfr's value: 0.10

In the mode of analog speed control, sometimes it requires adjusting coincidence relation among upper limit and lower limit of input analog, analog changes and output frequency, to achieve a satisfactory speed control effect.

·Upper and lower limit of analog input are set by F400 and F402.

For example: when F400=1, F402=8, if analog input voltage is lower than 1V, system judges it as 0. If input voltage is higher than 8V, system judges it as 10V (Suppose analog channel selects 0-10V). If Max frequency F111 is set to 50Hz, the output frequency corresponding to 1-8V is 0-50Hz.

·The filtering time constant is set by F405.

The greater the filtering time constant is, the more stable for the analog testing. However, the precision may decrease to a certain extent. It may require appropriate adjustment according to actual application.

·Channel proportional gain is set by F404.

If 1V corresponds to 10Hz and F404=2, then 1V will correspond to 20Hz.

·Corresponding setting for upper / lower limit of analog input are set by F401 and F403.

If Max frequency F111 is 50Hz, analog input voltage 0-10V can correspond to output frequency from -50Hz to 50Hz by setting this group function codes. Please set F401=0 and F403=2, then 0V corresponds to -50Hz, 5V corresponds to 0Hz and 10V corresponds to 50Hz. The unit of corresponding setting for upper / lower limit of input is in percentage (%). If the value is greater than 1.00, it is positive; if the value is less than 1.00, it is negative. (e.g. F401=0.5 represents -50%).

If the running direction is set to forward running by F202, then 0-5V corresponding to the minus frequency will cause reverse running, or vice versa.

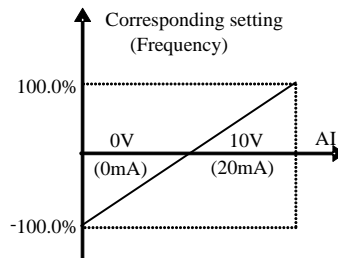
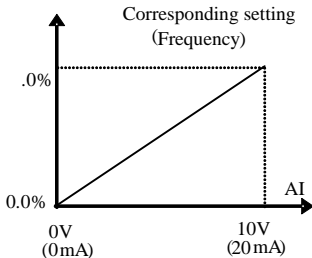

Fig 5-12 correspondence of analog input to setting

The unit of corresponding setting for upper / lower limit of input is in percentage (%). If the value is greater than 1.00, it is positive; if the value is less than 1.00, it is negative. (e.g. F401=0.5 represents -50%). The corresponding setting benchmark: in the mode of combined speed control, analog is the accessorial frequency and the setting benchmark for range of accessorial frequency which relates to main frequency (F205=1) is "main frequency X"; corresponding setting benchmark for other cases is the "max frequency", as illustrated in the right figure:

$$A = (F401-1) * \text{setting value}$$

$$B = (F403-1) * \text{setting value}$$

$$C = F400 \quad D = F402$$

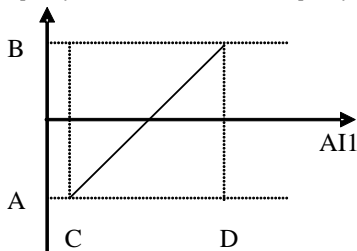

F406	Lower limit of AI2 channel input	Setting range: 0.00~F408	Mfr's value: 0.04
F407	Corresponding setting for lower limit of AI2 input	Setting range: 0~F409	Mfr's value: 1.00
F408	Upper limit of AI2 channel input	Setting range: F406~10.00V	Mfr's value: 10.00
F409	Corresponding setting for upper limit of AI2 input	Setting range: Max (1.00, F407) ~2.00	Mfr's value: 2.00
F410	AI2 channel proportional gain K2	Setting range: 0.0~10.0	Mfr's value: 1.0
F411	AI2 filtering time constant	Setting range: 0.1~10.00	Mfr's value: 0.10
F412	Lower limit of AI3 channel input	Setting range: 0.00~F414	Mfr's value: 0.05
F413	Corresponding setting for lower limit of AI3 input	Setting range: 0~F415	Mfr's value: 1.00
F414	Upper limit of AI3 channel input	Setting range: F412~10.0V	Mfr's value: 10.00
F415	Corresponding setting for upper limit of AI3 input	Setting range: Max (1.00, F413) ~2.00	Mfr's value: 2.00
F416	AI3 channel proportional gain K1	Setting range: 0.0~10.0	Mfr's value: 1.0
F417	AI3 filtering time constant	Setting range: 0.1~10.00	Mfr's value: 0.10

The function of AI2 and AI3 is the same with AI1.

F418	AI1 channel 0Hz voltage dead zone	Setting range: 0.00~1.00	Mfr's value: 0.00
F419	AI2 channel 0Hz voltage dead zone	Setting range: 0.00~1.00	Mfr's value: 0.00
F420	AI3 channel 0Hz voltage dead zone	Setting range: 0~0.50V (Positive-Negative)	Mfr's value: 0.00

Analog input voltage 0-5V can correspond to output frequency -50Hz-50Hz (2.5V corresponds to 0Hz) by setting the function of corresponding setting for upper / lower limit of analog input. The group function codes of F418, F419 and F420 set the voltage range corresponding to 0Hz. For example, when F418=0.5, F419=0.5 and F420=0.5, the voltage range from (2.5-0.5=2) to (2.5+0.5=3) corresponds to 0Hz. So if F418=N, F419=N and F420=N, then 2.5±N should correspond to 0Hz. If the voltage is in this range, inverter will output 0Hz. 0HZ voltage dead zone will be valid when corresponding setting for lower limit of input is less than 1.00.

F421 Panel selection	Setting range: 1: Auto switchover between remote control keypad and local keypad 2: Local keypad+ remote keypad	Mfr's value: 1
F422 Potentiometer selection	Setting range: 0: Potentiometer in local panel 1: Potentiometer in remote control panel	Mfr's value: 0

When F421 is set to 0, local keypad panel is working. When F421 is set to 1, remote control keypad panel is working, and local keypad panel will be invalid for saving energy. For 30kw and below 30kw inverters, local keypad will be valid after removing remote control keypad.

F422 is used to select potentiometer.

If F421=1, local keypad panel is valid, so even if F422=0, the potentiometer in remote control panel does not work.

When F160 is set to 1, the values of F421 and F422 can not be reverted to Mfr's values.

The remote control panel is connected by 8-cores net cable.

F423 AO1 output range	Setting range: 0: 0-5V; 1: 0-10V or 0-20mA 2: 4-20mA	Mfr's value: 1
F424 AO1 lowest corresponding frequency	Setting range: 0.0~F425	Mfr's value: 0.05
F425 AO1 highest corresponding frequency	Setting range: F424~F111	Mfr's value: 50.00
F426 AO1 output compensation	Setting range: 0~120%	Mfr's value: 100

· AO1 output range is selected by F423. When F423=0, AO1 output range selects 0-5V, and when F423=1, AO1 output range selects 0-10V or 0-20mA. When F423=2, AO1 output range selects 4-20mA (When AO1 output range selects current signal, please turn the switch J5 to 'I' position, below 15 kW and 15 kW inverters do not have this function)

· Correspondence of output voltage range (0-5V or 0-10V) to output frequency is set by F424 and F425. For example, when F423=0, F424=10 and F425=120, analog channel AO1 outputs 0-5V and the output frequency is 10-120Hz.

· AO1 output compensation is set by F426. Analog excursion can be compensated by setting F426.

F427 AO2 output range	Setting range: 0: 0~20mA; 1: 4~20 mA	Mfr's value: 0
F428 AO2 lowest corresponding frequency	Setting range: 0.0~F429	Mfr's value: 0.05
F429 AO2 highest corresponding frequency	Setting range: F428~F111	Mfr's value: 50.00
F430 AO2 output compensation	Setting range: 0~120%	Mfr's value: 100

The function of AO2 is the same as AO1, but AO2 will output current signal, current signal of 0-20mA and 4-20mA could be selected by F427.

F431 AO1 analog output signal selecting	Setting range: 0: Running frequency; 1: Output current; 2: Output voltage; 3: Analog AI1 4: Analog AI2 5: Reserved 6: Output torque 7: Given by PC/PLC 8: Target frequency	Mfr's value: 0
F432 AO2 analog output signal selecting		Mfr's value: 1

· Token contents output by analog channel are selected by F431 and F432. Token contents include running frequency, output current and output voltage.

·When output current is selected, analog output signal is from 0 to twofold rated current.

·When output voltage is selected, analog output signal is from 0V to rated output voltage (230V or 400V).

F433	Corresponding current for full range of external voltmeter	Setting range: 0.01~5.00 times of rated current	Mfr's value: 2.00
F434	Corresponding current for full range of external ammeter		Mfr's value: 2.00

·In case of F431=1 and AO1 channel for token current, F433 is the ratio of measurement range of external voltage type ammeter to rated current of the inverter.

·In case of F432=1 and AO2 channel for token current, F434 is the ratio of measurement range of external current type ammeter to rated current of the inverter.

For example: measurement range of external ammeter is 20A, and rated current of the inverter is 8A, then, $F433=20/8=2.50$.

F437	Analog filter width	Setting range: 1~100	Mfr's value:10
------	---------------------	----------------------	----------------

The greater the setting value of F437 is, the steadier the detecting analog is, but the response speed will decrease. Please set it according to the actual situations.

F438	Input signal of AI1 channel	Setting range: 0: voltage 1: current	Mfr's value: 0
F439	Input signal of AI2 channel	Setting range: 0: voltage 1: current	Mfr's value: 1

When F438=0, AI1 channel is voltage signal input, when F438=1, AI1 channel is current signal input.

When F439=0, AI2 channel is voltage signal input, when F439=1, AI2 channel is current signal input.

F460	AI1 channel input mode	Setting range: 0: straight line mode 1: folding line mode	Mfr's value: 0
F461	AI2 channel input mode	Setting range: 0: straight line mode 1: folding line mode	Mfr's value: 0
F462	AI1 insertion point A1 voltage value	Setting range: F400~F464	Mfr's value: 2.00
F463	AI1 insertion point A1 setting value	Setting range: F401~F465	Mfr's value: 1.20
F464	AI1 insertion point A2 voltage value	Setting range: F462~F466	Mfr's value: 5.00
F465	AI1 insertion point A2 setting value	Setting range: F463~F467	Mfr's value: 1.50
F466	AI1 insertion point A3 voltage value	Setting range: F464~F402	Mfr's value: 8.00
F467	AI1 insertion point A3 setting value	Setting range: F465~F403	Mfr's value: 1.80
F468	AI2 insertion point B1 voltage value	Setting range: F406~F470	Mfr's value: 2.00
F469	AI2 insertion point B1 setting value	Setting range: F407~F471	Mfr's value: 1.20
F470	AI2 insertion point B2 voltage value	Setting range: F468~F472	Mfr's value: 5.00
F471	AI2 insertion point B2 setting value	Setting range: F469~F473	Mfr's value: 1.50
F472	AI2 insertion point B3 voltage value	Setting range: F470~F412	Mfr's value: 8.00
F473	AI2 insertion point B3 setting value	Setting range: F471~F413	Mfr's value: 1.80

When analog channel input mode selects straight-line, please set it according to the parameters from F400 to F429. When folding line mode is selected, three points A1(B1), A2(B2), A3(B3) are inserted into the straight line, each of which can set the according frequency to input voltage. Please refer to the following figure:

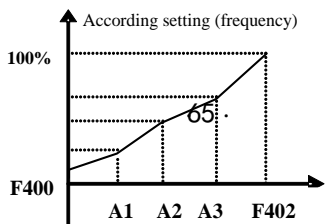

F400 and F402 are lower/upper limit of analog AI1 input. When F460=1, F462=2.00V, F463=1.4, F111=50, F203=1, F207=0, then A1 point corresponding frequency is $(F463-1) * F111=20\text{Hz}$, which means 2.00V corresponding to 20Hz. The other points can be set by the same way.

AI2 channel has the same setting way as AI1.

5.5 Multi-stage Speed Control

The function of multi-stage speed control is equivalent to a built-in PLC in the inverter. This function can set running time, running direction and running frequency.

E800 series inverter can realize 15-stage speed auto circulating and 8-stage speed auto circulating. During the process of speed track, multi-stage speed control is invalid. After speed track is finished, inverter will run to target frequency according to the setting value of parameters.

F500 Stage speed type	Setting range: 0: 3-stage speed; 1: 15-stage speed; 2: Max 8-stage speed auto circulating	Mfr's value: 1
F580 Stage-speed mode selection	Setting range: 0: mode 1(0000 means invalid, 0001 means the first speed, and so on.) 1: mode 2 (0000 means the first speed, 0001 means the second speed, and so on. 1111 means invalid).	Mfr's value: 0

In case of multi-stage speed control (F203=4), the user must select a mode by F500. When F500=0, 3-stage speed is selected. When F500=1, 15-stage speed is selected. When F500=2, max 8-stage speed auto circulating is selected. When F500=2, "auto circulating" is classified into "2-stage speed auto circulating", "3-stage speed auto circulating", ... "8-stage speed auto circulating", which is to be set by F501.

Table 5-5 Selection of Stage Speed Running Mode

F203	F500	Mode of Running	Description
4	0	3-stage speed control	The priority in turn is stage-1 speed, stage-2 speed and stage-3 speed. It can be combined with analog speed control. If F207=4, "3-stage speed control" is prior to analog speed control.
4	1	15-stage speed control	It can be combined with analog speed control. If F207=4, "15-stage speed control" is prior to analog speed control.
4	2	Max 8-stage speed auto circulating	Adjusting the running frequency manually is not allowable. "2-stage speed auto circulating", "3-stage speed auto circulating", ... "8-stage speed auto circulating" may be selected through setting the parameters.
F501	Selection of Stage Speed Under Auto-circulation Speed Control		Setting range: 2~8 Mfr's value: 7
F502	Selection of Times of Auto-circulation Speed Control		Setting range: 0~9999 (when the value is set to 0, the inverter will carry out infinite circulating) Mfr's value: 0
F503	Status After Auto-circulation Running Finished.		Setting range: 0: Stop 1: Keep running at last-stage speed Mfr's value: 0

· If running mode is auto-circulation speed control (F203=4 and F500=2), please set the related parameters by F501~F503.

· That the inverter runs at the preset stage speed one by one under the auto-circulation speed control is called as "one time".

· If F502=0, inverter will run at infinite auto circulation, which will be stopped by "stop" signal.

· If F502>0, inverter will run at auto circulation conditionally. When auto circulation of the preset times is finished continuously (set by F502), inverter will finish auto-circulation running conditionally. When

inverter keeps running and the preset times is not finished, if inverter receives “stop command”, inverter will stop. If inverter receives “run command” again, inverter will auto circulate by the setting time by F502.

·If F503=0, then inverter will stop after auto circulation is finished. If F503=1, then inverter will run at the speed of the last-stage after auto-circulation is finished as follows:

e.g., F501=3, then inverter will run at auto circulation of 3-stage speed;

F502=100, then inverter will run 100 times of auto circulation;

F503=1, inverter will run at the speed of the last stage after the auto-circulation running is finished.

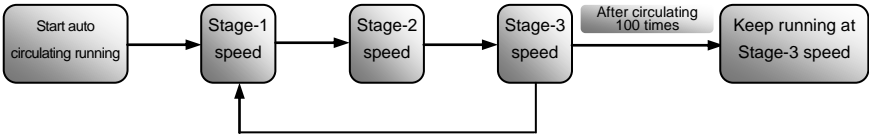

Figure 5-11 Auto-circulating Running

Then the inverter can be stopped by pressing “stop” or sending “stop” signal through terminal during auto-circulation running.

F504	Frequency setting for stage 1 speed (Hz)	Setting range: F112~F111	Mfr's value: 5.00
F505	Frequency setting for stage 2 speed (Hz)		Mfr's value: 10.00
F506	Frequency setting for stage 3 speed (Hz)		Mfr's value: 15.00
F507	Frequency setting for stage 4 speed (Hz)		Mfr's value: 20.00
F508	Frequency setting for stage 5 speed (Hz)		Mfr's value: 25.00
F509	Frequency setting for stage 6 speed (Hz)		Mfr's value: 30.00
F510	Frequency setting for stage 7 speed (Hz)		Mfr's value: 35.00
F511	Frequency setting for stage 8 speed (Hz)		Mfr's value: 40.00
F512	Frequency setting for stage 9 speed (Hz)		Mfr's value: 5.00
F513	Frequency setting for stage 10 speed (Hz)		Mfr's value: 10.00
F514	Frequency setting for stage 11 speed (Hz)		Mfr's value: 15.00
F515	Frequency setting for stage 12 speed (Hz)		Mfr's value: 20.00
F516	Frequency setting for stage 13 speed (Hz)		Mfr's value: 25.00
F517	Frequency setting for stage 14 speed (Hz)		Mfr's value: 30.00
F518	Frequency setting for stage 15 speed (Hz)		Mfr's value: 35.00
F519~F533	Acceleration time setting for the speeds from Stage 1 to Stage 15 (S)	Setting range: 0.1~3000S	Mfr's value: subject to inverter's model
F534~F548	Deceleration time setting for the speeds from Stage 1 to Stage 15 (S)	Setting range: 0.1~3000S	
F549~F556	Running directions of stage speeds from Stage 1 to Stage 8	Setting range: 0: forward running; 1: reverse running	

F573~F579 Running directions of stage speeds from stage 9 to stage 15	Setting range: 0: forward running; 1: reverse running	Mfr's value: 0
F557~564 Running time of stage speeds from Stage 1 to Stage 8 (S)	Setting range: 0.1~3000S	Mfr's value: 1.0S
F565~F572 Stop time after finishing stages from Stage 1 to Stage 8 (S)	Setting range: 0.0~3000S	Mfr's value: 0.0S

5.6 Auxiliary Functions

F600 DC Braking Function Selection	Setting range: 0: Invalid; 1: braking before starting; 2: braking during stopping; 3: braking during starting and stopping	Mfr's value: 0
F601 Initial Frequency for DC Braking	Setting range: 0.20~5.00	Mfr's value: 1.00
F602 DC Braking current before Starting	Setting range: 0~250 for 30kW and below 30kW 0~200 for above 30kW	Mfr's value: 50
F603 DC Braking current during Stop		Mfr's value: 100
F604 Braking Lasting Time Before Starting	Setting range: 0.0~30.0	Mfr's value: 0.5
F605 Braking Lasting Time During Stopping		

· When F600=0, DC braking function is invalid.

· When F600=1, braking before starting is valid. After the right starting signal is input, inverter starts DC braking. After braking is finished, inverter will run from the initial frequency.

In some application occasion, such as fan, motor is running at a low speed or in a reverse status, if inverter starts immediately, OC malfunction will occur. Adopting “braking before starting” will ensure that the fan stays in a static state before starting to avoid this malfunction.

During braking before starting, if “stop” signal is given, inverter will stop by deceleration time.

When F600=2, DC braking during stopping is selected, after output frequency declines to initial frequency for DC braking, the rotating motor is stop by DC braking.

During the process of braking during stopping, if “start” signal is given, DC braking is finished and inverter will start.

If “stop” signal is given during the process of braking during stopping and inverter has no response, DC braking during stopping still goes on.

The function of DC braking before starting is invalid during the process of speed tracing.

· Parameters related to “DC Braking”: F601, F602, F604 and F605, interpreted as follows:

- F601: Initial frequency of DC-braking. DC braking will start to work as inverter's output frequency is lower than this value.
- F602: DC braking current. The bigger value will result in a quick braking. However, motor will overheat with too big value.
- F604: Braking duration before starting. The time lasted for DC braking before inverter starts.
- F605: Braking duration when stopping. The time lasted for DC braking while inverter stops.

DC braking, as shown in Figure 5-11

Note: during DC braking, because motor does not have auto-cold effect cause by rotating, it is in the state of easy over-heat. Please do not set DC braking voltage too high and do not set DC braking time to long.

F607 Selection of Stalling Adjusting Function	Setting range: 0~2:Reserved	Mfr's value: 3
---	--------------------------------	----------------

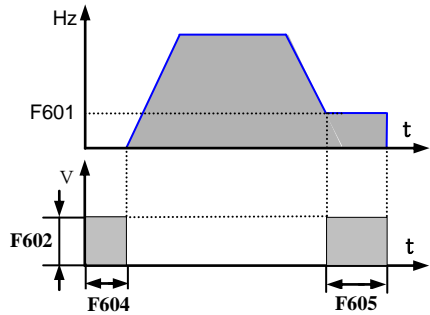

Figure 5-11 DC Braking

		3: Voltage/current control 4: Voltage control 5: Current control	
F608	Stalling Current Adjusting (%)	Setting range: 60~200	Mfr's value: 160
F609	Stalling Voltage Adjusting (%)	Setting range: 110~200	Mfr's value: 1-phase: 130 3-phase: 140

Initial value of stalling current adjusting is set by F608, when the present current is higher than rated current of inverter*F608, stalling current adjusting function is valid.

During the process of acceleration, if output current is higher than initial value of stalling current adjusting, inverter will not accelerate until the output current is lower than initial value of stalling current adjusting.

In case of stalling during stable speed running, the frequency will drop.

F607 is used to set selection of stalling adjusting function.

Voltage control: when motor stops quickly or load changes suddenly, DC bus voltage will be high. Voltage control function can adjust deceleration time and output frequency to avoid OE.

When braking resistor or braking unit is used, please do not use voltage control function. Otherwise, the deceleration time will be changed.

Current control: when motor accelerates quickly or load changed suddenly, inverter may trip into OC. Current control function can adjust accel/decel time or decrease output frequency to control proper current value. It is only valid in VF control mode and vector control mode 1. In SVC control mode, current is controlled by F822 at speed mode.

Note: (1) Voltage/current control is not suitable for lifting application.

(2) This function will change accel/decel time. Please use this function properly.

Initial value of stalling voltage adjusting is set by F609.

F611	Dynamic Braking threshold	Setting range: 200~1000	Mfr's value: subject to model
F612	Dynamic braking duty ratio (%)	Setting range: 0~100	Mfr's value: 80

Initial voltage of dynamic braking threshold is set by F611, which of unit is V. When DC bus voltage is higher than the setting value of this function, dynamic braking starts, braking unit starts working. After DC bus voltage is lower than the setting value, braking unit stops working.

The value of F611 should be set according to input voltage. When the input voltage is 400V, F611 should be set to 700V, when input voltage is 460V, F611 should be set to 770V. The lower the dynamic braking threshold is, the better dynamic braking effect is. But the heat of braking resistor is more serious. The higher the dynamic braking threshold is, the worse dynamic braking effect is. And at the process of braking, inverter will easily trip to OE.

Dynamic braking duty ratio is set by F612, the range is 0~100%. The value is higher, the braking effect is better, but the braking resistor will get hot.

F613	Speed track	Setting range: 0: invalid 1: valid 2: valid at the first time	Mfr's value: 0
------	-------------	---	----------------

When F613=0, the function of speed track is invalid.

When F613=1, the function of speed track is valid.

After inverter tracks motor speed and rotating direction, inverter will begin running according to the tracked frequency, to start the rotating motor smoothly. This function is suitable for the situation of auto-starting after re-powered on, starting after reset, auto-starting when running command valid but direction signal lost and auto-starting when running command invalid.

When F613=2, the function is valid at the first time after inverter is re-power on.

When F106=6, the function of speed track is invalid.

F614 Speed track mode	Setting range: 0: Speed track from frequency memory 1: Speed track from max frequency 2: Speed track from zero	Mfr's value: 0
-----------------------	---	----------------

When F614 is set to 0, inverter will track speed down from frequency memory.

When F614 is set to 1, inverter will track speed down from max frequency.

When F614 is set to 2, inverter will track speed up from 0Hz.

F615 Speed track rate	Setting range: 1~100	Mfr's value: 20
-----------------------	----------------------	-----------------

It is used to select the rotation velocity speed track when the rotation tracking restart mode is adopted. The larger the parameter is, the faster the speed track is. But if this parameter is too large, it likely results in unreliable tracking.

F618 Delay time of speed track (S)	Setting range: 0.5~60.0	Mfr's value: 1.5
------------------------------------	-------------------------	------------------

F622 Dynamic braking mode	Setting range: 0: Fixed duty ratio 1: Auto duty ratio	Mfr's value: 1
---------------------------	--	----------------

When F622=0, fixed duty ratio is valid. When bus-line voltage reaches energy consumption brake point set by F611, braking module will start dynamic braking according to F612.

When F622=1, auto duty ratio is valid. When bus-line voltage reaches dynamic braking threshold set by F611, braking module will start dynamic braking according to duty ratio which is adjusted by the bus-line voltage. The higher bus-line voltage is, the greater duty ratio is, and the better braking effect is. But braking resistor will get hotter.

F631 VDC adjustment selection	Setting range: 0: invalid 1: valid 2,3: reserved	Mfr's value: 0
F632 Target voltage of VDC adjustor (V)	Setting range: 200~800	Mfr's value: subject to model

When F631=1, VDC adjustment function is valid. During motor running process, the PN bus voltage will raise suddenly because of load mutation, over-voltage protection will occur. VDC adjustment is used to control voltage steady by adjusting output frequency or reducing braking torque.

If the DC bus voltage is higher than the setting value of F632, VDC adjustor will automatically adjust the bus voltage same as the value of F632.

When F106=6, the VDC function is invalid.

Note: 30kW and above 30kW inverters do not have VDC function.

F638 Parameter copy function	Setting range 0: forbid to copy 1: copy mode 1(rated voltage and power rating is same) 2: copy mode 2(ignore rated voltage and power rating)	Mfr's value: 1
------------------------------	---	----------------

F639 Parameter copy code		Mfr's value: subject to model
--------------------------	--	-------------------------------

If the copy code is different, it is forbidden to copy parameters for different inverters.

The below is the error list during copying parameter.

Item	Description	note
Er71 timeout error	Inverter doesn't receive valid data during copying	

Er72	running error	When copying parameter, inverter is running.	
Er73	password error	Inverter's password is not entered during copying.	
Er74	mismatching error	Copy code, power rating or rated voltage does not match.	
Er75	forbid to copy	F638=0	

F640	Parameter copy type	Setting range: 0: Copy all parameters 1: Copy parameters (except motor parameters from F801 to F810/F844)	Mfr's value: 1
F641	Inhibition of current oscillation at low frequency	Setting range: 30kw and below 30kw: 0: Invalid 1: Valid 37kW and above 37Kw: 0~100	Subject to inverter model

When F641=0, inhibition function is invalid.

In the V/F control mode, if inhibition of current oscillation is valid, the following parameters are needed to be set.

- (1) F106=2 (V/F control mode) and F137≤2;
- (2) F613=0, the speed track function is invalid.

Note 1. When F641=1, one inverter can only drive one motor one time.

2. When F641=1, please set motor parameters (F801~F805, F844) correctly.
3. When inhibition oscillation function is invalid, and inverter runs without motor, output voltage may be unbalanced. This is normal situation. After inverter runs with motor, output voltage will be balanced.

5.7. Malfunction and Protection

F700 Selection of terminal free stop mode	Setting range: 0: free stop immediately; 1: delayed free stop	Mfr's value: 0
F701 Delay time for free stop and programmable terminal action	Setting range: 0.0~60.0	Mfr's value: 0.0

“Selection of free stop mode” can be used only for the mode of “free stop” controlled by the terminal. The related parameters setting is F201=1, 2, 4 and F209=1.

When “free stop immediately” is selected, delay time (F701) will be invalid and inverter will free stop immediately.

· “Delayed free stop” means that upon receiving “free stop” signal, the inverter will execute “free stop” command after waiting some time instead of stopping immediately. Delay time is set by F701. During the process of speed track, the function of delayed free stop is invalid.

F702 Fan control mode	0: controlled by temperature 1: Running when inverter is powered on. 2: controlled by running status 3: Fan runs periodically	Mfr's value: 2
-----------------------	--	----------------

· For E1 structure inverters, if F702=0, the function is reserved.

· When F702=0, fan will run if radiator's temperature is up to setting temperature.

· When F702=2, fan will run when inverter begins running. When inverter stops, fan will run according to the temperature of radiator.

· To control fan's running can increase the life of fan.

· When F702=3, fan is controlled by temperature. When the temperature is lower, fan will run 1 minute every 24 hours.

F704 Inverter Overloading pre-alarm Coefficient (%)	Setting range: 50~100	Mfr's value: 80
F705 Motor Overloading pre-alarm Coefficient (%)	Setting range: 50~100	Mfr's value: 80
F706 Inverter Overloading Coefficient (%)	Setting range: 100~150	Mfr's value: 120
F707 Motor Overloading Coefficient (%)	Setting range: 20~100	Mfr's value: 100

· Inverter overloading coefficient: the ratio of overload-protection current and rated current, whose value shall be subject to actual load.

· Motor overloading coefficient (F707): when inverter drives lower power motor, please set the value of F707 by below formula in order to protect motor

$$\text{Motor Overloading Coefficient} = \frac{\text{Actual motor current}}{\text{Rated current of inverter}} \times 100\%$$

Please set F707 according to actual situation. The lower the setting value of F707 is, the faster the overload protection speed. Please refer to Fig 5-14.

For example: 7.5 kW inverter drives 5.5 kW motor, $F707 = \frac{5.5}{7.5} \times 100\% \approx 70\%$. When the actual current of motor reaches 140% of inverter rated current, inverter overload protection will display after 1 minute.

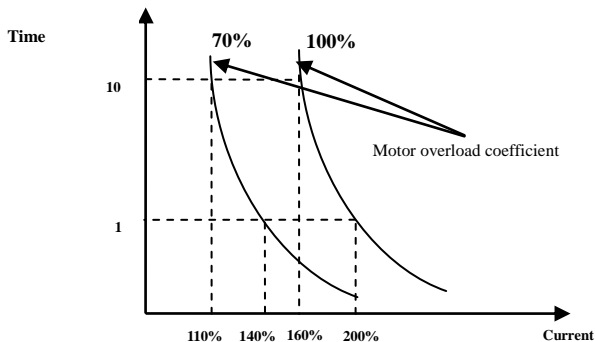

Fig 5-19 Motor overload coefficient

When the output frequency is lower than 10Hz, the heat dissipation effect of common motor will be worse. So when running frequency is lower than 10Hz, the threshold of motor overload value will be reduced. Please refer to Fig 5-15 (F707=100%):

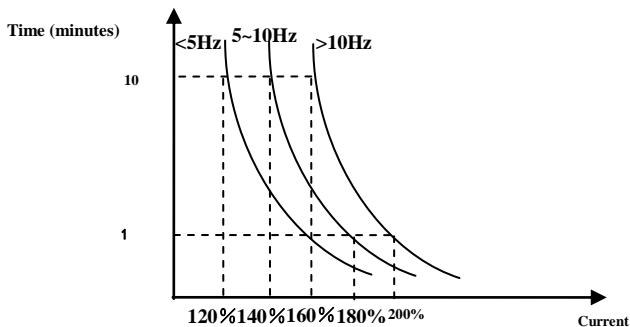

Fig 5-20 Motor overload protection value

F708	Record of The Latest Malfunction Type	Setting range: 2: over current (OC) 3: over voltage (OE) 4: input phase loss (PF1) 5: inverter overload (OL1) 6: under voltage (LU) 7: overheat (OH) 8: motor overload (OL2) 11: external malfunction (ESP) 12: current fault before running (Err3) 13. studying parameters without motor (Err2) 15: Current sampling fault (Err4) 16: over current 1 (OC1) 17: output phase loss (PF0)	
F709	Record of Malfunction Type for Last but One		
F710	Record of Malfunction Type for Last but Two		

		23: PID parameters are set wrong (Err5) 32: PMSM distuning fault (PCE) 45: Communication timeout (CE) 49: Watchdog (Err6)	
F711	Fault Frequency of The Latest Malfunction		
F712	Fault Current of The Latest Malfunction		
F713	Fault PN Voltage of The Latest Malfunction		
F714	Fault Frequency of Last Malfunction but One		
F715	Fault Current of Last Malfunction but One		
F716	Fault PN Voltage of Last Malfunction but One		
F717	Fault Frequency of Last Malfunction but Two		
F718	Fault Current of Last Malfunction but Two		
F719	Fault PN Voltage of Last Malfunction but Two		
F720	Record of overcurrent protection fault times		
F721	Record of overvoltage protection fault times		
F722	Record of overheat protection fault times		
F723	Record of overload protection fault times		
F724	Input phase loss	Setting range: 0: invalid; 1: valid	Mfr's value: 1
F725	Under-voltage	Setting range: 1: Manual reset 2: Auto reset	Mfr's value: 2
F726	Overheat	Setting range: 0: invalid; 1: valid	Mfr's value: 1
F727	Output phase loss	Setting range: 0: invalid; 1: valid	Subject to inverter model
F728	Input phase loss filtering constant	Setting range: 0.1~60.0	Mfr's value: 0.5
F730	Overheat protection filtering constant	Setting range: 0.1~60.0	Mfr's value: 5.0
F732	Voltage threshold of under-voltage protection	Setting range: 100~450	Mfr's value: subject to model

“Under-voltage” refers to too low voltage at AC input side.

“Input phase loss” refers to phase loss of three-phase power supply, 7.5 kW and below 7.5 kW inverters have no this function.

“Output phase loss” refers to phase loss of inverter three-phase wirings or motor wirings.

If inverter trips into the status of under-voltage in the running status,

When F725=1, inverter will reset by manual after bus voltage returns to normal.

When F725=2, inverter will reset automatically after bus voltage returns to normal.

F737	Over-current 1 protection	Setting range: 0:Invalid 1: Valid	Mfr's value: 1
F738	Over-current 1 protection coefficient	Setting range: 0.50~3.00	Mfr's value: 2.5
F739	Over-current 1 protection record		

·F738= OC 1 value/inverter rated current

·In running status, F738 is not allowed to modify. When over-current occurs, OC1 is displayed

F741 Analog disconnected protection	Setting range: 0: Invalid 1: Stop and AErr displays. 2: Stop and AErr does not display. 3: Inverter runs at the min frequency. 4: Reserved.	Mfr's value: 0
F742 Threshold of analog disconnected protection (%)	Setting range: 1~100	Mfr's value: 50

When the values of F400 and F406 are lower than 0.01V, analog disconnected protection is invalid. Analog channel AI3 has no disconnected protection.

When F741 is set to 1, 2 or 3, the values of F400 and F406 should be set to 1V-2V, to avoid the error protection by interference.

Analog disconnected protection voltage=analog channel input lower limit * F742. Take the AI1 channel for the example, if F400=1.00, F742=50, then disconnection protection will occur when the AI1 channel voltage is lower than 0.5V.

F745 Threshold of pre-alarm overheat (%)	Setting range: 0~100	Mfr's value: 80
F747 Carrier frequency auto-adjusting	Setting range: 0: Invalid 1: Valid	Mfr's value: 1

When the temperature of radiator reaches the value of 95℃ X F745 and multi-function output terminal is set to 16 (Please refer to F300~F302), it indicates inverter is in the status of overheat.

When F747=1, the temperature of radiator reaches 86℃, inverter carrier frequency will adjust automatically, to decrease the temperature of inverter. This function can avoid overheat malfunction.

When F159=1, random carrier frequency is selected, F747 is invalid.

F753 Selection of overload protection	Setting range: 0: Normal motor 1: variable frequency motor	Mfr's value: 1
---------------------------------------	--	----------------

When F753=0, because heat dissipation effect of normal motor is bad in low speed, the electronic thermal protection value will be adjusted properly. It means overload protection threshold of motor will be decreased when running frequency is lower than 30Hz.

When F753=1, because heat dissipation effect of variable frequency motor is not influenced by speed, there is no need to adjust the protection value.

F754 Zero-current threshold (%)	Setting range: 0~200	Mfr's value: 5
F755 Duration time of zero-current	Setting range: 0.0~60.0	Mfr's value: 0.5

When the output current is fallen to zero-current threshold, and after the duration time of zero-current, ON signal is output.

5.8 Parameters of the Motor

F800	Motor's parameters tuning	Setting range: 0: Invalid; 1: Rotating tuning; 2: stationary tuning	Mfr's value: 0
F801	Rated power (kW)	Setting range: 0.1~1000	
F802	Rated voltage (V)	Setting range: 1~440	
F803	Rated current (A)	Setting range: 0.2~6553.5	
F804	Number of motor poles	Setting range: 2~100	Mfr's value: 4
F805	Rated rotary speed (rpm/min)	Setting range: 1~30000	
F810	Motor rated frequency (Hz)	Setting range: 1.00~590.0	Mfr's value: 50.00
F870	PMSM back electromotive force (mV/rpm)	Setting range: 0.1~999.9 (valid value between lines)	Subject to inverter model
F871	PMSM D-axis inductance (mH)	Setting range: 0.01~655.35	
F872	PMSM Q-axis inductance (mH)	Setting range: 0.01~655.35	
F873	PMSM stator resistance (Ω)	Setting range: 0.001~65.535 (phase resistor)	

Please set the parameters in accordance with those indicated on the nameplate of the motor.

Excellent control performance of vector control requires accurate parameters of the motor. Accurate parameter tuning requires correct setting of rated parameters of the motor.

In order to get the excellent control performance, please configure the motor in accordance with adaptable motor of the inverter. In case of too large difference between the actual power of the motor and that of adaptable motor for inverter, the inverter's control performance will decrease remarkably.

F800=0, parameter tuning is invalid. But it is still necessary to set the parameters F801~F803, F805 and F810 correctly according to those indicated on the nameplate of the motor.

After being powered on, it will use default parameters of the motor (see the values of F806-F809) according to the motor power set in F801. This value is only a reference value in view of Y series 4-pole asynchronous motor. For PMSM, please input motor parameters to F870~F873 manually.

F800=1, rotating tuning.

In order to ensure dynamic control performance of the inverter, select "rotating tuning" after ensuring that the motor is disconnected from the load. Please set F801-805 and F810 correctly prior to running testing.

Operation process of rotating tuning: Press the "Run" key on the keypad to display "TEST", and it will tune the motor's parameter of two stages. After that, the motor will accelerate according to acceleration time set at F114 and maintain it for a certain period. The motor will then decelerate to 0 according to the time set at F115. After auto-checking is completed, relevant parameters of the IM motor will be stored in function codes F806~F809. And relevant parameters of PMSM will be stored in F870~F873. F800 will turn to 0 automatically

F800=2, stationary tuning.

It is suitable for the cases where it is impossible to disconnect the motor from the load.

Press the "Run" key, and the inverter will display "TEST", and it will tune the motor's parameter of two stages. The motor's stator resistance, rotor resistance and leakage inductance will be stored in F806-F809 automatically (the motor's mutual inductance uses default value generated according to the power). For PMSM, electric parameters are stored to F870~F873. F870 is theory value, user can ask the accurate

back electromotive force from manufacture. And F800 will turn to 0 automatically. The user may also calculate and input the motor's mutual inductance value manually according to actual conditions of the motor. With regard to calculation formula and method, please call us for consultation.

When tuning the motor's parameter, motor is not running but it is powered on. Please do not touch motor during this process.

***Note:**

1. No matter which tuning method of motor parameter is adopted, please set the information of the motor (F801-F805) correctly according to the nameplate of the motor. If the operator is quite familiar with the motor, the operator may input all the parameters (F806-F809) of the motor manually.

2. Parameter F804 can only be checked, not be modified.

3. Incorrect parameters of the motor may result in unstable running of the motor or even failure of normal running. Correct tuning of the parameters is a fundamental guarantee of vector control performance.

Each time when F801 rated power of the motor is changed, the parameters of the motor (F806-F809) will be refreshed to default settings automatically. Therefore, please be careful while amending this parameter.

The motor's parameters may change when the motor heats up after running for a long time. If the load can be disconnected, we recommend auto-checking before each running.

* F870(back electromotive force of PMSM, unit = 0.1mV/1rpm, it is back electromotive force value between lines), it is forbidden to revert to Mfr's value by F160.

* F871(PMSM D-axis inductance, unit = 0.01 mH), it is forbidden to revert to Mfr's value by F160.

* F872(PMSM Q-axis inductance, unit = 0.01 mH), it is forbidden to revert to Mfr's value by F160.

* F873(PMSM Stator resistance, unit = m-ohm, 0.001 ohm), it is forbidden to revert to Mfr's value by F160.

* F870-F873 are motor parameters of PMSM, they are not shown in the motor nameplate. User can get them by auto tuning or asking manufacture.

F806	Stator resistance (Ω)	Setting range: 0.001~65.53Ω (for 30kw and below 30kw) 0.1~6553mΩ (For above 30kw)	Subject to inverter model
F807	Rotor resistance (Ω)	Setting range: 0.001~65.53Ω (for 30kw and below 30kw) 0.1~6553mΩ (For above 30kw)	
F808	Leakage inductance (mH)	Setting range: 0.01~655.3mH (for 30kw and below 30kw) 0.001~65.53mH (for above 30kw)	
F809	Mutual inductance (mH)	Setting range: 0.01~655.3mH (for 30kw and below 30kw) 0.001~65.53mH (for above 30kw)	
F844	Motor no-load current (A)	Setting range: 0.1~F803	

The set values of F806~F809 will be updated automatically after normal completion of parameter tuning of the motor.

If it is impossible to measure the motor at the site, input the parameters manually by referring to the known parameters of a similar motor.

F844 can be got automatically by rotating tuning.

If the no-load current is higher when motor is running, please decrease the value of F844.

If running current or start current is higher when motor is running with load, please increase the value of F844.

Take a 3.7kW inverter for the example: all data are 3.7kW, 400V, 8.8A, 1440rpm, 50Hz, and the load is disconnected. When F800=1, the operation steps are as following:

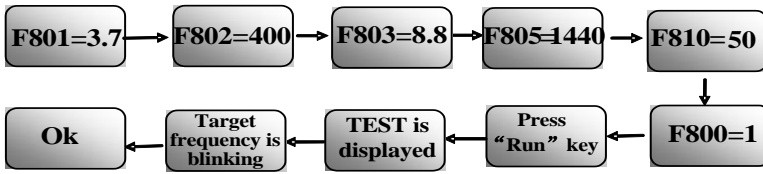

F812	Pre-exciting time (S)	Setting range: 0.00~30.00	Mfr's value: 0.3
------	-----------------------	---------------------------	------------------

F813	Rotary speed loop KP1		Subject to inverter model
F814	Rotary speed loop KI1		
F815	Rotary speed loop KP2		
F816	Rotary speed loop KI2		
F817	PID switching frequency 1	Setting range: 0~F818	
F818	PID switching frequency 2	Setting range: F817~F111	

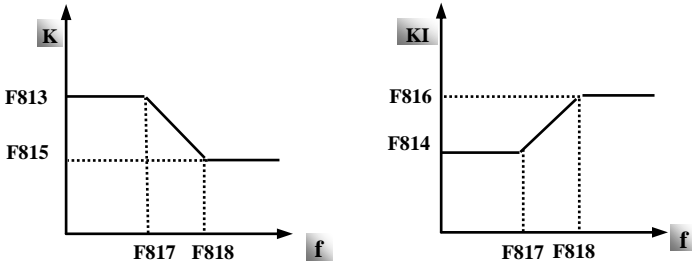

Fig 6-22 PID parameter

Dynamic response of vector control speed can be adjusted through adjusting proportional and storage gains of speed loop. Increasing KP and decreasing KI can speed up dynamic response of speed loop. However, if proportional gain or storage gain is too large, it may give rise to oscillation.

Recommended adjusting procedures:

Make fine adjustment of the value on the basis of manufacturer value if the manufacturer setting value cannot meet the needs of practical application. Be cautious that amplitude of adjustment each time should not be too large.

In the event of weak loading capacity or slow rising of rotary speed, please decrease the value of KP first under the precondition of ensuring no oscillation. If it is stable, please increase the value of KI properly to speed up response.

In the event of oscillation of current or rotary speed, decrease KP and increase KI properly.

Note: Improper setting of KP and KI may result in violent oscillation of the system, or even failure of normal operation. Please set them carefully.

F876	PMSM injection current without load (%)	Setting range: 0.0~100.0	Mfr's value: 20.0
F877	PMSM injection current compensation without load (%)	Setting range: 0.0~50.0	Mfr's value: 0.0

F878 PMSM cut-off point of injection current compensation without load (%)	Setting range: 0.0~50.0	Mfr's value: 10.0
F880 PMSM PCE detection time (S)	Setting range: 0.0~10.0	Mfr's value: 0.2

F876, F877 and F879 are the percent of rated current. F878 is the percent of rated frequency.

For example:

When F876=20, if F877=10 and F878=0, the injection current without load is 20% of rated current.

When F876=20, if F877=10 and F878=10, and rated frequency is 50Hz, injection current without load will decrease by a linear trend from 30 (F876+F877). When inverter runs to 5Hz (5Hz=rated frequency X F878%), injection current will decrease to 20, and 5Hz is cut-off point of injection current compensation without load.

5.9 Communication Parameter

F900 Communication Address	1~255: single inverter address 0: broadcast address	Mfr's value: 1
F901 Communication Mode	1: ASCII 2: RTU	Mfr's value: 2
F902 Stop bits	Setting range: 1~2	Mfr's value: 2
F903 Parity Check	0: Invalid 1: Odd 2: Even	Mfr's value: 0
F904 Baud Rate	Setting range: 0: 1200; 1: 2400; 2: 4800; 3: 9600; 4: 19200 5: 38400 6: 57600	Mfr's value: 3

F904=9600 is recommended for baud rate, which makes run steady.

F905 Communication timeout period	Setting range: 0~3000	Mfr's value:0
-----------------------------------	-----------------------	---------------

When F905 is set to 0.0, the function is invalid. When F905 \neq 0.0, if the inverter has not received effective command from PC/PLC during the time set by F905, inverter will trip into CE.

5.10 PID Parameters

5.10.1 Internal PID adjusting and constant pressure water supply

Internal PID adjusting control is used for single pump or double pump automatic constant-pressure water supply, or used for simple close-loop system with convenient operation.

The usage of pressure meter:

As FA02=1: channel AI1

“10V” connect with the power supply of pressure meter, if the power supply of pressure meter is 5V, please supply a 5V power.

“AI1” connect with the pressure signal port of pressure meter

“GND” connect with the grounding of pressure meter

As FA02=2: channel AI2

“10V” connect with the power supply of pressure meter, if the power supply of pressure meter is 5V, please supply a 5V power.

“AI2” connect with the pressure signal port of pressure meter

“GND” connect with the grounding of pressure meter

For current type sensor, two-line 4-20mA signal is inputted to inverter, please connect CM to GND, and 24V is connected to power supply of sensor.

5.10.2 Parameters

FA00 Water supply mode	Setting range: 0: Single pump (PID control mode) 1: Fixed mode 2: Timing interchanging	Mfr's value: 0
------------------------	---	----------------

When FA00=0 and single pump mode is selected, the inverter only controls one pump. The control mode can be used in the closed-loop control system, for example, pressure, flow.

When FA00=1, one motor is connected with converter pump or general pump all the time.

When FA00=2, two pumps are interchanging to connect with inverter for a fixed period of time, this function should be selected. The duration time is set by FA25.

FA01 PID adjusting target given source	Setting range: 0: FA04 1: AI1 2: AI2 3: AI3	Mfr's value: 0
--	--	----------------

When FA01=0, PID adjusting target is given by FA04 or MODBUS.

When FA01=1, PID adjusting target is given by external analog AI1.

When FA01=2, PID adjusting target is given by external analog AI2.

When FA01=3, PID adjusting target is given by external analog AI3.

FA02 PID adjusting feedback given source	Setting range: 1: AI1 2: AI2	Mfr's value: 1
--	------------------------------	----------------

When FA02=1, PID adjusting feedback signal is given by external analog AI1.

When FA02=2, PID adjusting feedback signal is given by external analog AI2.

FA03 Max limit of PID adjusting (%)	Setting range: FA04~100.0	Mfr's value: 100.0
FA04 Digital setting value of PID adjusting (%)	Setting range: FA05~FA03	Mfr's value: 50.0
FA05 Min limit of PID adjusting (%)	Setting range: 0.1~FA04	Mfr's value: 0.0

When negative feedback adjusting is valid, if pressure is higher than max limit of PID adjusting, pressure protection will occur. If inverter is running, it will free stop, and “nP” is displayed. When positive feedback adjusting is valid, if pressure is higher than Max limit, it indicates that feedback pressure is too low, inverter should accelerate or a linefrequency should be added to increase the displacement.

When FA01=0, the value set by FA04 is digital setting reference value of PID adjusting.

When positive feedback adjusting is valid, if pressure is higher than min limit of PID adjusting, pressure protection will occur. If inverter is running, it will free stop, and “nP” is displayed. When negative feedback adjusting, if pressure is higher than min limit, it indicates that feedback pressure is too low, inverter should accelerate or a linefrequency should be added to increase the displacement.

For example: if the range of pressure meter is 0-1.6MPa, then setting pressure is $1.6*70\%=1.12\text{MPa}$, and the max limit pressure is $1.6*90\%=1.44\text{MPa}$, and the min limit pressure is $1.6*5\%=0.08\text{MPa}$.

FA06 PID polarity	Setting range: 0: Positive feedback 1: Negative feedback	Mfr's value: 1
-------------------	---	----------------

When FA06=0, the higher feedback value is, the higher the motor speed is. This is positive feedback.

When FA06=1, the lower the feedback value is, the higher the motor speed is. This is negative feedback.

FA07 Dormancy function selection	Setting range: 0: Valid 1: Invalid	Mfr's value: 1
----------------------------------	------------------------------------	----------------

When FA07=0, if inverter runs at the min frequency FA09 for a period time set by FA10, inverter will stop.

When FA07=1, the dormancy function is invalid.

FA09 Min frequency of PID adjusting (Hz)	Setting range: Max(F112, 0.1)~F111	Mfr's value: 5.00
--	------------------------------------	-------------------

The min frequency is set by FA09 when PID adjusting is valid.

FA10 Dormancy delay time (S)	Setting range: 0.0~500.0	Mfr's value: 15.0
------------------------------	--------------------------	-------------------

When FA07=0, inverter runs at min frequency FA09 for a period time set by FA10, inverter will free stop and enter into the dormancy status, "SLP" is displayed.

FA11 Wake delay time (S)	Setting range: 0.0~3000	Mfr's value: 3.0
--------------------------	-------------------------	------------------

After the wake delay time, if the pressure is lower than min limit pressure (Negative feedback), inverter will begin running immediately, or else, inverter will be in the dormancy status.

FA12 Max frequency of PID	Setting range: FA09-F111	Mfr's value: 50.00
---------------------------	--------------------------	--------------------

FA18 Whether PID adjusting target is changed	Setting range: 0: Invalid 1: Valid	Mfr's value: 1
--	------------------------------------	----------------

When FA18=0 and FA01≠0, PID adjusting target cannot be changed.

FA19 Proportion Gain P	Setting range: 0.00~10.00	Mfr's value: 0.30
------------------------	---------------------------	-------------------

FA20 Integration time I (S)	Setting range: 0.1~100.0	Mfr's value: 0.3
-----------------------------	--------------------------	------------------

FA21 Differential time D (S)	Setting range: 0.0~10.0	Mfr's value: 0.0
------------------------------	-------------------------	------------------

FA22 PID sampling period (S)	Setting range: 0.1~10.0	Mfr's value: 0.1
------------------------------	-------------------------	------------------

Increasing proportion gain, decreasing integration time and increasing differential time can increase the dynamic response of PID closed-loop system. But if P is too high, I is too low or D is too high, system will not be steady.

PID adjusting period is set by FA22. It affects PID adjusting speed.

The following is PID adjusting arithmetic.

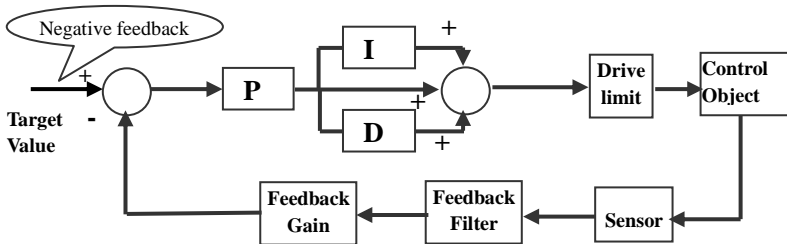

FA23 PID negative frequency output	Setting range: 0: Invalid 1: valid 2: only output negative frequency	Mfr's value: 0
------------------------------------	---	----------------

When FA23=0, PID output frequency is FA09~FA12.

When FA23=1, PID output frequency is -FA12~FA12, - means reverse direction.

When FA23=2, PID output frequency is -FA12~0. - means reverse direction.

FA24 Switching Timing unit setting	Setting range: 0: hour 1: minute	Mfr's value: 0
------------------------------------	----------------------------------	----------------

FA25 Switching Timing Setting	1~9999	Mfr's value: 100
Switching time is set by F525. The unit is set by F524.		
FA26 Under-load protection mode	Setting Range 0: No protection 1: Protection by contactor 2: Protection by PID 3: Protection by current	Mfr's value: 0
FA27 Current threshold of under-load protection (%)	Setting range: 10~150	Mfr's value: 80
FA66 Duration time of under-load protection	Setting range: 0~60	Mfr's value: 20

Note: the percent of under-load protection current corresponds to motor rated current.

Under-load protection is used to save energy. For some pumps device, when the output power is too low, the efficiency will get worse, so we suggest that the pumps should be closed.

During the running process, if the load decreases to zero suddenly, it means the mechanical part is broken. For example, belt is broken or water pump is dried up. Under-load protection must occur.

When FA26=1, water signal and lack water signal is controlled by two input terminals. When the lack water terminal is valid, inverter will enter into the protection status, and EP1 is displayed. When the water terminal is valid, inverter will deactivate EP1 fault automatically.

When FA26=2, PID adjusting frequency runs to max frequency, if inverter current is lower than the product FA27 and rated current, inverter will enter PID under-load protection status immediately, and EP2 is displayed.

When FA26=3, if inverter current is lower than the product of FA27 and rated current, after duration time of FA66, inverter will enter under-load protection, and EP3 is displayed.

FA28 Waking time after protection (min)	1~3000	Mfr's value: 60
---	--------	-----------------

After the duration time of FA28, inverter will judge that whether the under-load protection signal disappears.

After resetting malfunction, inverter will run again. Or else inverter will wait until malfunction is reset. User can reset the inverter by pressing "stop/reset", inverter will stop.

FA29 PID dead time (%)	0.0~10.0	Mfr's value: 2.0
FA30 Running Interval of restarting converter pump (S)	2.0~999.9	Mfr's value: 20.0
FA31 Delay time of starting general pumps (S)	0.1~999.9	Mfr's value: 30.0
FA32 Delay time of stopping general pumps (S)	0.1~999.9	Mfr's value: 30.0

FA29, PID dead time has two functions. First, setting dead time can restrain PID adjustor oscillation. The greater this value is, the lighter PID adjustor oscillation is. But if the value of FA29 is too high, PID adjusting precision will decrease. For example: when FA29=2.0% and FA04=70, PID adjusting will not invalid during the feedback value from 68 to 72.

Second, FA29 is set to PID dead time when starting and stopping general pumps by PID adjusting. When negative feedback adjusting is valid, if feedback value is lower than value FA04-FA29 (which equal to set value MINUS dead-time value), inverter will delay the set time of FA31, and then start the general pump. If feedback value is higher than value FA04+FA29 (which equal to set value PLUS dead-time value), inverter will delay the set time of FA32, then stop the general pump.

·When starting general pump or interchange time is over, inverter will free stop. After starting general pump, inverter will delay the set time of FA30, and restart converter pump.

·When inverter drives two pumps and negative feedback adjusting, if the frequency already reach the max value and after the delay time (FA31), the pressure value is still lower than the value, then the inverter will stop output immediately and motor will freely stop. At the same time, the general pump will be started. After the general pump is fully run, if the present pressure is higher than the set value, inverter will low down the output to the min frequency. After delaying the set time (FA32), inverter will stop the general pump and start converter pump.

·When inverter drives two pumps and positive feedback adjusting, if the frequency already reach the max value and after the delay time (FA31), the pressure value still higher than the value, then the inverter will stop output

immediately and motor will freely stop. At the same time the general pump will be started. After the general pump runs, if the present pressure is lower than the set value, inverter will low down the output to the min frequency. After delaying the set time (FA32), inverter will stop the general pump and start converter pump.

FA33 stop mode when constant pressure water supply	0: free stop 1: deceleration to stop	Mfr's value: 0
--	---	----------------

FA33 is used to set the stop mode after inverter stops converter pump or trips into nP and EP.

FA36 Whether No.1 relay is available	0: unavailable 1: available	Mfr's value: 0
FA37 Whether No.2 relay is available	0: unavailable 1: available	Mfr's value: 0

No 1 relay corresponds to the terminal DO1 in the control PCB, No 2 relay corresponds to the terminal TA/TC

FA47 The sequence of starting No 1 relay	Setting range: 1~20	Mfr's value: 20
FA48 The sequence of starting No 2 relay	Setting range: 1~20	Mfr's value: 20

The sequence of starting relays is set by FA47~FA48. The setting value of FA47 and FA48 must be different with each other, or else "Err5" is displayed in the keypad.

FA58 Fire pressure given value (%)	Setting range: 0.0~100.0	Mfr's value: 80.0
------------------------------------	--------------------------	-------------------

FA58 is also called second pressure, when the fire control terminal is valid, pressure target value will switch into second pressure value.

FA59 Emergency fire mode	Setting range: 0: Invalid 1: Emergency fire mode 1 2: Emergency fire mode 2	Mfr's value: 0
--------------------------	---	----------------

When emergency fire mode is valid and emergency fire terminal is valid, inverter will be forbidden operating and protecting (When OC and OE protection occur, inverter will reset automatically and start running). And inverter will run at the frequency of FA60 or target frequency until inverter is broken.

Emergency fire mode 1: when the terminal is valid, inverter will run at target frequency.

Emergency fire mode 2: when the terminal is valid, inverter will run at the frequency of FA60.

FA60 Running frequency of emergency fire	Setting range: F112~F111	Mfr's value: 50.0
--	--------------------------	-------------------

When the emergency fire mode 2 is valid and the fire terminal is valid, inverter will run at the frequency set by FA60.

FA62 when fire emergency control terminal is invalid	Setting range: 0~1	Mfr's value: 0
--	--------------------	----------------

When FA62=0, inverter keeps working at fire emergency mode.

When FA62=1, inverter will quit from fire emergency mode.

5.11 Torque control parameters

FC00 Speed/torque control selection	0: Speed control 1: Torque control 2: Terminal switchover	Mfr's value: 0
-------------------------------------	---	----------------

0: speed control. Inverter will run by setting frequency, and output torque will automatically match with the torque of load, and output torque is limited by max torque (set by manufacture.)

1: Torque control. Inverter will run by setting torque, and output speed will automatically match with the speed of load, and output speed is limited by max speed (set by FC23 and FC25). Please set the proper torque and speed limited.

2: Terminal switchover. User can set DIX terminal as torque/speed switchover terminal to realize switchover between torque and speed. When the terminal is valid, torque control is valid. When the terminal is invalid, speed control is valid.

FC02 Torque accel/decel time (S)	0.1~100.0	Mfr's value: 1.0
----------------------------------	-----------	------------------

The time is for inverter to run from 0% to 100% of rated torque.

FC06 Torque given channel	0: Digital given (FC09) 1: Analog input AI1 2: Analog input AI2 3: Analog input AI3 4, 5: Reserved	Mfr's value: 0
---------------------------	--	----------------

When FC06=4, only DI1 terminal can be selected because only DI1 terminal has the pulse input function.

FC07 Torque given coefficient	0~3.000	Mfr's value: 3.000
FC09 Torque given command value (%)	0~300.0	Mfr's value: 100.0

FC07: when input given torque reaches max value, FC07 is the ratio of inverter output torque and motor rated torque. For example, if FC06=1, F402=10.00, FC07=3.00, when AI1 channel output 10V, the output torque of inverter is 3 times of motor rated torque.

FC14 Offset torque given channel	0: Digital given (FC17) 1: Analog input AI1 2: Analog input AI2 3: Analog input AI3 4, 5: Reserved	Mfr's value: 0
FC15 Offset torque coefficient	0~0.500	Mfr's value: 0.500
FC16 Offset torque cut-off frequency (%)	0~100.0	Mfr's value: 10.00
FC17 Offset torque command value (%)	0~50.0	Mfr's value: 10.00

· Offset torque is used to output larger start torque which equals to setting torque and offset torque when motor drives big inertia load. When actual speed is lower than the setting frequency by FC16, offset torque is given by FC14. When actual speed is higher than the setting frequency by FC16, offset torque is 0.

· When FC14≠0, and offset torque reaches max value, FC15 is the ratio of offset torque and motor rated torque. For example: if FC14=1, F402=10.00 and FC15=0.500, when AI1 channel outputs 10V, offset torque is 50% of motor rated torque.

FC22 Forward speed limited channel	0: Digital given (FC23) 1: Analog input AI1 2: Analog input AI2 3: Analog input AI3 4, 5: Reserved	Mfr's value: 0
FC23 Forward speed limited (%)	0~100.0	Mfr's value: 10.0

FC24 Reverse speed limited channel	0: Digital given (FC25) 1: Analog input AI1 2: Analog input AI2 3: Analog input AI3 4, 5: Reserved	Mfr's value: 0
FC25 Reverse speed limited (%)	0~100.0	Mfr's value: 10.0

Speed limited FC23/FC25: if given speed reaches max value, they are used to set percent of inverter output frequency and max frequency F111.

FC28	Electric torque limit channel	0: Digital given (FC30) 1: Analog input AI1 2: Analog input AI2 3: Analog input AI3 4, 5: Reserved	0
FC29	Electric torque limit coefficient	0~3.000	3.000
FC30	Electric torque limit (%)	0~300.0	200.0
FC33	Braking torque limit channel	0: Digital given (FC35) 1: Analog input AI1 2: Analog input AI2 3: Analog input AI3 4, 5: Reserved	0
FC34	Braking torque limit coefficient	0~3.000	3.000
FC35	Braking torque limit (%)	0~300.0	200.0

When motor is in the electric status, output torque limit channel is set by FC28. When FC28 does not equal to 0, limit torque is set by FC29. When FC28= 0, limit torque is set by FC30.

When motor is in the Braking status, Braking torque limit channel is set by FC31. When FC33 does not equal to 0, limit torque is set by FC34. When FC33= 0, limit torque is set by FC35.

Appendix 1 Trouble Shooting

When malfunction occurs to inverter, don't run by resetting immediately. Check any causes and get it removed if there is any.

Take counter measures by referring to this manual in case of any malfunctions on inverter. Should it still be unsolved, contact the manufacturer. Never attempt any repairing without due authorization.

Table 1-1 Inverter's Common Cases of Malfunctions

Fault	Description	Causes	Countermeasures
Err0	Prohibition modify function code	* prohibition modify the function code during running process.	* Please modify the function code in stopped status.
Err1	Wrong password	*Enter wrong password when password is valid * Do not enter password when modifying function code.	* Please enter the correct password.
2: O.C.	Over-current	* too short acceleration time	*prolong acceleration time;
16: OC1	Over-current 1	* short circuit at output side * locked rotor with motor	*whether motor cable is broken; *check if motor overloads;
67: OC2	Over-current 2	* Too heavy load. * parameter tuning is not correct.	*reduce V/F compensation value * measure parameter correctly.
3: O.E.	DC Over-Voltage	*supply voltage too high; *load inertia too big *deceleration time too short; *motor inertia rise again * bad effect of dynamic braking *parameter of rotary speed loop PID is set abnormally.	*check if rated voltage is input; *add braking resistance(optional); *increase deceleration time * Enhancing the dynamic braking effect *set the parameter of rotary speed loop PID correctly. * Change to VF control for centrifugal fan.
4: P.F1.	Input Phase loss	*phase loss with input power	*check if power input is normal; *check if parameter setting is correct.
5: O.L1	Inverter Overload	* load too heavy	*reduce load; *check drive ratio; *increase inverter's capacity
6: L.U.	Under-Voltage Protection	*input voltage on the low side	*check if supply voltage is normal *check if parameter setting is correct.
7: O.H.	Radiator Overheat	*environment temperature too high; *radiator too dirty *install place not good for ventilation; *fan damaged * Carrier wave frequency or compensation curve is too high.	*improve ventilation; *clean air inlet and outlet and radiator; *install as required; *change fan * Decrease carrier wave frequency or compensation curve.
8: O.L2	Motor Overload	* load too heavy	*reduce load; *check drive ratio; *increase motor's capacity
11: ESP	External fault	*External emergency-stop terminal is valid.	*Check external fault.
12: Err3	Current malfunction before running	*Current alarm signal exists before running.	*check if control board is connected with power board well. *ask for help from manufacture.

13: Err2	Parameters tuning wrong	* Do not connect motor when measuring parameters	*please connect motor correctly.
15: Err4	Current zero excursion malfunction	*Flat cable is loosened. *Current detector is broken.	*check the flat cable. *ask for help from manufacture.
17: PF0	Output Phase loss	* Motor is broken * Motor wire is loose. * Inverter is broken	* check if wire of motor is loose. * check if motor is broken.
18: Aerr	Line disconnected	* Analog signal line disconnected * Signal source is broken.	* Change the signal line. * Change the signal source.
19: EP3 20: EP/EP2	Inverter under-load	* Water pump dries up. * Belt is broken. * Equipment is broken.	* Supply water for pump * Change the belt. * Repair the equipment.
22: nP	Pressure control	* Pressure is too high when negative feedback. * Pressure is too low when positive feedback.	* Decrease the min frequency of PID.
23: Err5	PID parameters are set wrong.	* PID parameters are set wrong.	* Set the parameters correctly.
24: SLP	Dormancy protection	* Inverter enters into the dormancy status.	* Reset inverter to normal status after pressure is normal.
32: PCE	PMSM distuning fault	*motor parameters measurement is wrong. *load is too heavy.	* Measure motor parameters correctly. * Decrease the load.
35: OH1	PTC overheat protection	*external relay protection.	*check external heat protection equipment.
44: Er44	Master loses slave's response	*communication fault between master and slave	* check wiring. *check baud rate *check communication parameters setting
45: CE	Communication timeout error	Communication fault	*PC/PLC does not send command at fixed time *Check whether the communication line is connected reliably.
47: EEEP	EEPROM read/write fault	*interference around *EEPROM is damaged.	* remove interferences *contact manufacturer.
49: Err6	Watchdog fault	Watchdog timeout	*please check watchdog signal
53: CE 1	Keypad disconnection protection	*Keypad disconnection	*Check communication line

No P.F1 protection for single-phase and three-phase under 7.5 kW.

Table 1-2 **Motor Malfunction and Counter Measures**

Malfunction	Items to Be Checked	Counter Measures
Motor not Running	Wiring correct? Setting correct? Too big with load? Motor is damaged? Malfunction protection occurs?	Get connected with power; Check wiring; Checking malfunction; Reduce load; Check against Table 1-1

Wrong Direction of Motor Running	U, V, W wiring correct? Parameters setting correct?	To correct wiring Setting the parameters correctly.
Motor Turning but Speed Change not Possible	Wiring correct for lines with given frequency? Correct setting of running mode? Too big with load?	To correct wiring; To correct setting; Reduce load
Motor Speed Too High or Too Low	Motor's rated value correct? Drive ratio correct? Inverter parameters are set uncorrected? Check if inverter output voltage is abnormal?	Check motor nameplate data; Check the setting of drive ratio; Check parameters setting; Check V/F Characteristic value
Motor Running Unstable	Too big load? Too big with load change? Phase loss? Motor malfunction.	Reduce load; reduce load change, increase capacity; Correct wiring.
Power Trip	Wiring current is too high?	Check input wiring; Selecting matching air switch; Reduce load; checking inverter malfunction.

Appendix 2 Products & Structures

E800 series inverter has its power range between 0.2~450 kW. Refer to Tables 2-1 and 2-2 for main data.

Inverter should operate under the rated output current, with overload permitted for a short time. However, it shall not exceed the allowable values at working time.

Table 2-1 **Product Summary of E800**

Model	Applicable motor (kW)	Rated Current Output	Structure Code	Cooling Mode	Remarks
E800-0002S2	0.2	1.5	E1	Air-Cooling	Single-Phase 230V Plastic Housing
E800-0004S2	0.4	2.5	E1	Air-Cooling	
E800-0005S2	0.55	3.5	E1	Air-Cooling	
E800-0007S2	0.75	4.5	E1	Air-Cooling	
E800-0011S2	1.1	5.0	E1	Air-Cooling	
E800-0015S2	1.5	7.0	E1	Air-Cooling	
E800-0022S2	2.2	10.0	E2	Air-Cooling	
E800-0007T2	0.75	4.5	E1	Air-Cooling	Three-Phase 230V Plastic Housing
E800-0015T2	1.5	7.0	E1	Air-Cooling	
E800-0022T2	2.2	10.0	E2	Air-Cooling	
E800-0002T3	0.2	0.6	E1	Air-Cooling	Three-phase 400V Plastic Housing
E800-0004T3	0.4	1	E1	Air-Cooling	
E800-0005T3	0.55	1.5	E1	Air-Cooling	
E800-0007T3	0.75	2.0	E1	Air-Cooling	
E800-0011T3	1.1	3.0	E1	Air-Cooling	
E800-0015T3	1.5	4.0	E1	Air-Cooling	
E800-0022T3	2.2	6.5	E2	Air-Cooling	
E800-0030T3	3.0	7.0	E2	Air-Cooling	
E800-0040T3	4.0	9.0	E2	Air-Cooling	
E800-0055T3	5.5	12.0	E2	Air-Cooling	
E800-0075T3	7.5	17.0	E4	Air-Cooling	
E800-0110T3	11	23.0	E5	Air-Cooling	
E800-0150T3	15	32.0	E5	Air-Cooling	
E800-0185T3	18.5	38.0	E6	Air-Cooling	
E800-0220T3	22	44.0	E6	Air-Cooling	
E800-0300T3	30	60	E6	Air-Cooling	
E800-0370T3	37	75	E7	Air-Cooling	
E800-0450T3	45	90	E7	Air-Cooling	

E800-0550T3	55	110	C4	Air-Cooling	Three-phase 400V Metal cabinet
E800-0750T3	75	150	C5	Air- Cooling	
E800-0900T3	90	180	C6	Air- Cooling	
E800-1100T3	110	220	C6	Air- Cooling	
E800-1320T3	132	265	C6	Air- Cooling	
E800-1600T3	160	320	C7	Air- Cooling	
E800-1800T3	180	360	C8	Air- Cooling	
E800-2000T3	200	400	C8	Air-Cooling	
E800-2200T3	220	440	C9	Air- Cooling	
E800-2500T3	250	480	CA	Air- Cooling	
E800-2800T3	280	530	CA	Air- Cooling	
E800-3150T3	315	580	CA1	Air- Cooling	
E800-3550T3	355	640	CA1	Air- Cooling	
E800-4000T3	400	690	CB	Air- Cooling	
E800-4500T3	450	770	CB	Air- Cooling	

Table 2-2 E800 Types of Product Structure

Structure Code	External Dimension [A×B(B1)×H(H1)] ^{note1}	Mounting Size(W×L)	Mounting Bolt	Remarks
E1	80×135 (142) ×138 (153)	70×128	M4	Plastic Housing
E2	106×150 (157) ×180 (195)	94×170	M4	
E3	106×170 (177) ×180 (195)	94×170	M4	
E4	138×152 (159) ×235 (248)	126×225	M5	
E5	156×170 (177) ×265 (280)	146×255	M5	
E6	205×196 (202) ×340 (358)	194×330	M5	
E7	265×235 (242) ×435 (465)	235×412	M6	
C4	315×234×480	274×465	M6	Metal Housing
C5	360×265×555	320×530	M8	
C6	410×300×630	370×600	M10	
C7	516×326×765	360×740	M10	
C8	560×342×910	390×882	M10	
C9	400×385×1310	280×1282	M10	
CA	535×380×1340	470×1310	M10	
CA1	600×380×1340	545×1310	M10	
CB	600×380×1593	545×1563	M10	

Note 1: the unit is mm.

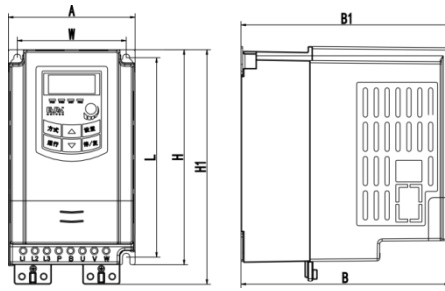

Plastic Profile

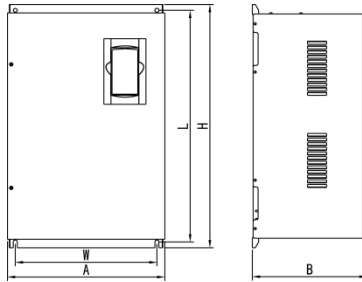

Metal Housing Profile

Appendix 3 Selection of Braking Resistance

Inverter model	Applicable motor power (kW)	Min resistor (Ω)	Min resistor power	Recommended resistor/power
E800-0004S2	0.4	80	200W	150 Ω /300W
E800-0007S2	0.75			
E800-0015S2	1.5			80 Ω /500W
E800-0022S2	2.2			
E800-0002T2	0.2	80	200W	150 Ω /300W
E800-0004T2	0.4			
E800-0007T2	0.75			
E800-0015T2	1.5			80 Ω /500W
E800-0022T2	2.2			
E800-0007T3	0.75	145	80W	300 Ω /300W
E800-0015T3	1.5	95	150W	150 Ω /300W
E800-0022T3	2.2	95	250W	
E800-0030T3	3.0	90	300W	90 Ω /1.5KW
E800-0040T3	4.0	90	400W	
E800-0055T3	5.5	90	550W	
E800-0075T3	7.5	90	750W	
E800-0110T3	11	50	1.1kW	50 Ω /1.5KW
E800-0150T3	15	30	1.5kW	30 Ω /3KW
E800-0185T3	18.5	30	2.0kW	
E800-0220T3	22	30	2.2kW	
E800-0300T3	30	25	3.0kW	
E800-0370T3	37	25	4.0kW	
E800-0450T3	45	15	4.0kW	15 Ω /4KW

Note: in the occasion of large inertia load, if the braking resistor heat is serious, please adopt the larger power of resistor than recommended resistor.

Appendix 4 Communication Manual

I. General

Modbus is a serial and asynchronous communication protocol. Modbus protocol is a general language applied to PLC and other controlling units. This protocol has defined an information structure which can be identified and used by a controlling unit regardless of whatever network they are transmitted.

You can read reference books or ask for the details of MODBUS from manufactures.

Modbus protocol does not require a special interface while a typical physical interface is RS485.

II. Modbus Protocol

2.1 Transmission mode

2.1.1 Format

1) ASCII mode

Start	Address	Function	Data				LRC check		End	
: (0X3A)	Inverter Address	Function Code	Data Length	Data 1	...	Data N	High-order byte of LRC	Low-order byte of LRC	Return (0X0D)	Line Feed (0X0A)

2) RTU mode

Start	Address	Function	Data	CRC check		End
T1-T2-T3-T4	Inverter Address	Function Code	N data	Low-order byte of CRC	High-order byte of CRC	T1-T2-T3-T4

2.1.2 ASCII Mode

In ASCII mode, one Byte (hexadecimal format) is expressed by two ASCII characters.

For example, 31H (hexadecimal data) includes two ASCII characters '3(33H)', '1(31H)'.

Common characters, ASCII characters are shown in the following table:

Characters	'0'	'1'	'2'	'3'	'4'	'5'	'6'	'7'
ASCII Code	30H	31H	32H	33H	34H	35H	36H	37H
Characters	'8'	'9'	'A'	'B'	'C'	'D'	'E'	'F'
ASCII Code	38H	39H	41H	42H	43H	44H	45H	46H

2.1.3 RTU Mode

In RTU mode, one Byte is expressed by hexadecimal format. For example, 31H is delivered to data packet.

2.2 Baud rate

Setting range: 1200, 2400, 4800, 9600, 19200, 38400, 57600

2.3 Frame structure:

ASCII mode

Byte	Function
1	Start Bit (Low Level)
7	Data Bit
0/1	Parity Check Bit (None for this bit in case of no checking. Otherwise 1 bit)
1/2	Stop Bit (1 bit in case of checking, otherwise 2 bits)

2) RTU mode

Byte	Function
1	Start Bit (Low Level)
8	Data Bit
0/1	Parity Check Bit (None for this bit in case of no checking. Otherwise 1 bit)
1/2	Stop Bit (1 bit in case of checking, otherwise 2 bits)

2.4 Error Check

2.4.1 ASCII mode

Longitudinal Redundancy Check (LRC): It is performed on the ASCII message field contents excluding the ‘colon’ character that begins the message, and excluding the CRLF pair at the end of the message. The LRC is calculated by adding together successive 8-bit bytes of the message, discarding any carries, and then two’s complementing the result.

A procedure for generating an LRC is:

1. Add all bytes in the message, excluding the starting ‘colon’ and ending CRLF. Add them into an 8-bit field, so that carries will be discarded.
2. Subtract the final field value from FF hex (all 1’s), to produce the ones-complement.
3. Add 1 to produce the twos-complement.

2.4.2 RTU Mode

Cyclical Redundancy Check (CRC): The CRC field is two bytes, containing a 16-bit binary value. The CRC is started by first preloading a 16-bit register to all 1’s. Then a process begins of applying successive 8-bit bytes of the message to the current contents of the register. Only the eight bits of data in each character are used for generating the CRC. Start and stop bits, and the parity bit, do not apply to the CRC.

A procedure for generating a CRC-16 is:

1. Load a 16-bit register with FFFF hex (all 1’s). Call this the CRC register.
2. Exclusive OR the first 8-bit byte of the message with the high-order byte of the 16-bit CRC register, putting the result in the CRC register.
3. Shift the CRC register one bit to the right (toward the LSB), zero-filling the MSB. Extract and examine the LSB.
4. (If the LSB was 0): Repeat Step 3 (another shift).
(If the LSB was 1): Exclusive OR the CRC register with the polynomial value A001 hex (1010 0000 0000 0001).
5. Repeat Steps 3 and 4 until 8 shifts have been performed. When this is done, a complete 8-bit byte will have been processed.

When the CRC is appended to the message, the low-order byte is appended first, followed by the

high-order byte.

2.4.3 Protocol Converter

It is easy to turn a RTU command into an ASCII command followed by the lists:

- 1) Use the LRC replacing the CRC.
- 2) Transform each byte in RTU command into a corresponding two byte ASCII. For example: transform 0x03 into 0x30, 0x33 (ASCII code for 0 and ASCII code for 3).
- 3) Add a 'colon' (:) character (ASCII 3A hex) at the beginning of the message.
- 4) End with a 'carriage return – line feed' (CRLF) pair (ASCII 0D and 0A hex).

So we will introduce RTU Mode in followed part. If you use ASCII mode, you can use the up lists to convert.

2.5 Command Type & Format

2.5.1 The listing below shows the function codes.

code	name	description
03	Read Holding Registers	Read the binary contents of holding registers in the slave. (Less than 10 registers once time)
06	Preset Single Register	Preset a value into holding register

2.5.2 Address and meaning

The part introduces inverter running, inverter status and related parameters setting.

Description of rules of function codes parameters address:

- 1) Use the function code as parameter address

General Series:

High-order byte: 01~0A (hexadecimal)

Low-order byte: 00~50 (max range) (hexadecimal) Function code range of each partition is not the same. The specific range refers to manual.

For example: parameter address of F114 is 010E (hexadecimal).

parameter address of F201 is 0201 (hexadecimal).

Note: in this situation, it allows to read six function codes and write only one function code. Some function codes can only be checked but cannot be modified; some function codes can neither be checked nor be modified; some function codes can not be modified in run state; some function codes can not be modified both in stop and run state.

In case parameters of all function codes are changed, the effective range, unit and related instructions shall refer to user manual of related series of inverters. Otherwise, unexpected results may occur.

- 2) Use different parameters as parameter address

(The above address and parameters descriptions are in hexadecimal format, for example, the decimal digit 4096 is represented by hexadecimal 1000).

1. Running status parameters

Parameters Address	Parameter Description (read only)
1000	Output frequency
1001	Output voltage

1002	Output current																										
1003	Pole numbers/ control mode, high-order byte is pole numbers, low-order byte is control mode.																										
1004	Bus-line voltage																										
1005 ---E800	<p>Drive ratio/inverter status High-order byte is drive ratio, low-order byte is inverter status Inverter status:</p> <table> <tr> <td>0X00: Standby mode</td> <td>0X01: Forward running</td> </tr> <tr> <td>0X02: Reverse running</td> <td>0X04: Over-current (OC)</td> </tr> <tr> <td>0X05: DC over-current (OE)</td> <td>0X06: Input Phase loss (PF1)</td> </tr> <tr> <td>0X07: Frequency Over-load (OL1)</td> <td>0X08: Under-voltage (LU)</td> </tr> <tr> <td>0X09: Overheat (OH)</td> <td>0X0A: Motor overload (OL2)</td> </tr> <tr> <td>0X0B: Interference (Err)</td> <td>0X0C: LL</td> </tr> <tr> <td>0X0D: External Malfunction (ESP)</td> <td>0X0E: Err3</td> </tr> <tr> <td>0X0F: Err2</td> <td>0X11: Err4</td> </tr> <tr> <td></td> <td>0X12: OC1</td> </tr> <tr> <td colspan="2">0X13: Output phase-loss (PF0)</td> </tr> <tr> <td colspan="2">0X19: PID parameters are set wrong (Err5)</td> </tr> <tr> <td colspan="2">0X2F: communication timeout (CE)</td> </tr> <tr> <td colspan="2">0X30: Speed track fault (FL) 0X33: Watchdog (Err6)</td> </tr> </table>	0X00: Standby mode	0X01: Forward running	0X02: Reverse running	0X04: Over-current (OC)	0X05: DC over-current (OE)	0X06: Input Phase loss (PF1)	0X07: Frequency Over-load (OL1)	0X08: Under-voltage (LU)	0X09: Overheat (OH)	0X0A: Motor overload (OL2)	0X0B: Interference (Err)	0X0C: LL	0X0D: External Malfunction (ESP)	0X0E: Err3	0X0F: Err2	0X11: Err4		0X12: OC1	0X13: Output phase-loss (PF0)		0X19: PID parameters are set wrong (Err5)		0X2F: communication timeout (CE)		0X30: Speed track fault (FL) 0X33: Watchdog (Err6)	
0X00: Standby mode	0X01: Forward running																										
0X02: Reverse running	0X04: Over-current (OC)																										
0X05: DC over-current (OE)	0X06: Input Phase loss (PF1)																										
0X07: Frequency Over-load (OL1)	0X08: Under-voltage (LU)																										
0X09: Overheat (OH)	0X0A: Motor overload (OL2)																										
0X0B: Interference (Err)	0X0C: LL																										
0X0D: External Malfunction (ESP)	0X0E: Err3																										
0X0F: Err2	0X11: Err4																										
	0X12: OC1																										
0X13: Output phase-loss (PF0)																											
0X19: PID parameters are set wrong (Err5)																											
0X2F: communication timeout (CE)																											
0X30: Speed track fault (FL) 0X33: Watchdog (Err6)																											
1006	Percentage of output torque																										
1007	Temperature of inverter radiator																										
1008	PID given value																										
1009	PID feedback value																										

Reading parameter address	Function	Remarks
100A	Read integer power value	The integer power value is read by PC.
100B	DI terminal status	DI1~DI8—bit0~bit7
100C	Terminal output status	bit0-OUT1 bit1-OUT2 bit2-fault relay
100D	AI1	0~4095 read input analog digital value
100E	AI2	0~4095 read input analog digital value
100F	AI3	0~4095 read input analog digital value
1010	Reserved	
1011	Reserved	
1012	Reserved	
1013	Present-stage speed value	Monitoring in which stage speed inverter is. 0000 Stage speed1 0001 stage speed 2 0010 Stage speed 3 0011 Stage speed 4 0100 Stage speed 5 0101 Stage speed 6 0110 Stage speed 7 0111 Stage speed 8 1000 Stage speed 9 1001 Stage speed 10 1010 Stage speed 11 1011 Stage speed 12 1100 Stage speed 13 1101 Stage speed 14 1110 Stage speed 15 1111 None
1014	Reserved	
1015	Monitoring analog output percent, AO1	(0~100.00)
1016	Monitoring analog output percent, AO2	(0~100.00)
1017	Monitoring current speed.	
1018	Read accurate power value, and correct the power to 1 decimal place.	
101A	Output current(when the current is too high, data overflow from 1002)	
101B	101A: high 16 bits of output current 101B: low 16 bits of output current	
101D	Inverter is ready. 0: Invalid 1: Valid	

2. Control commands

Parameters Address	Parameters Description (write only)
2000 ^{Note 1}	Command meaning: 0001: Forward running (no parameters) 0002: Reverse running (no parameters) 0003: Deceleration stop 0004: Free stop 0005: Forward jogging start 0006: Forward jogging stop 0007: Reserved 0008: Run (no directions) 0009: Fault reset 000A: Forward jogging stop 000B: Reverse jogging stop
2001 ^{Note 2}	Lock parameters 0001: Relieve system locked (remote control locked) 0002: Lock remote control (any remote control commands are no valid before unlocking) 0003: RAM and eeprom are permitted to be written. 0004: Only RAM is permitted to be written, eeprom is prohibited being written.

2002	AO1 output percent is set by PC/PLC. Setting range: 0~1000 Token output analog 0~100.0%
2003	AO2 output percent is set by PC/PLC. Setting range: 0~1000 Token output analog 0~100.0%
2004	Reserved
2005	Multi-function output terminal DO1 1 means token output is valid. 0 means token output is invalid.
2006	Multi-function output terminal DO2 1 means token output is valid. 0 means token output is invalid.
2007	Relay output terminal 1 means token output is valid. 0 means token output is invalid.

Note1: It is not each model that has the commands set by 2000.

Note2: It is default setting that parameter modification by PC/PLC is only written to RAM. If customer want to write it into EEPROM, please unlock firstly (2001=0003, F219=0).

3. Illegal Response When Reading Parameters

Command Description	Function	Data
Slave parameters response	The highest-order byte changes into 1.	Command meaning: 0001: Illegal function code 0002: Illegal address 0003: Illegal data 0004: Slave fault ^{note 3}

Note 3: Illegal response 0004 appears below two cases:

1. Do not reset inverter when inverter is in the malfunction state.
2. Do not unlock inverter when inverter is in the locked state.

2.5.3 Additional Remarks

Expressions during communication process:

Parameter Values of Frequency=actual value X 100 (General Series)

Parameter Values of Time=actual value X 10

Parameter Values of Current=actual value X 10

Parameter Values of Voltage=actual value X 1

Parameter Values of Power (100A) =actual value X 1

Parameter Values of Power (1018) =actual value X 10

Parameter Values of Drive Ratio=actual value X 100

Parameter Values of Version No. =actual value X 100

Instruction: Parameter value is the value sent in the data package. Actual value is the actual value of inverter. After PC/PLC receives the parameter value, it will divide the corresponding coefficient to get

the actual value.

NOTE: Take no account of radix point of the data in the data package when PC/PLC transmits command to inverter. The valid value is range from 0 to 65535.

III Function Codes Related to Communication

Function Code	Function Definition	Setting Range	Mfr's Value
F200	Source of start command	0: Keypad command; 1: Terminal command; 2: Keypad+ Terminal; 3:MODBUS; 4: Keypad+ Terminal+ MODBUS	4
F201	Source of stop command	0: Keypad command; 1: Terminal command; 2: Keypad+ Terminal; 3:MODBUS; 4: Keypad+ Terminal+ MODBUS	4
F203	Main frequency source X	0: Digital setting memory; 1: External analog AI1; 2: External analog AI2; 3: Reserved; 4: Stage speed control; 5: No memory by digital setting; 6: External analog AI3 7~8: Reserved; 9: PID adjusting 10: MODBUS	0
F900	Inverter Address	1~255	1
F901	Modbus Mode Selection	1: ASCII mode 2: RTU mode	2
F903	Parity Check	0: Invalid 1: Odd 2: Even	0
F904	Baud Rate	0: 1200 1: 2400 2: 4800 3: 9600 4: 19200 5: 38400 6: 57600	3

Please set functions code related to communication consonant with the PLC/PC communication parameters, when inverter communicates with PLC/PC.

IV Physical Interface

4.1 Interface instruction

Communication interface of RS485 is located on the most left of control terminals, marked underneath with A+ and B-

4.2 Structure of Field Bus

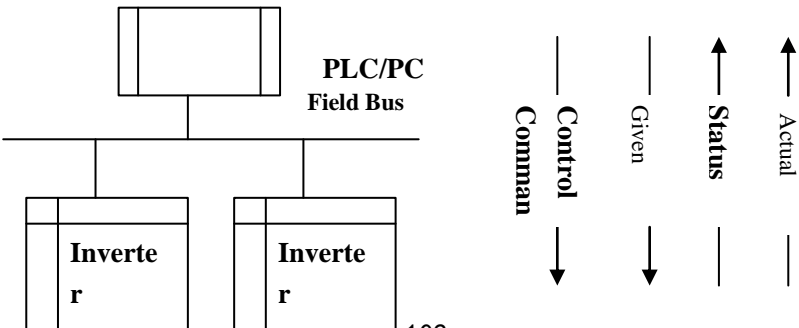

RS485 Half-duplex communication mode is adopted for E800 series inverter. Daisy chain structure is adopted by 485 Bus-line. Do not use 'spur' lines or a star configuration. Reflect signals which are produced by spur lines or star configuration will interfere in 485 communications.

Please note that for the same time in half-duplex connection, only one inverter can have communication with PC/PLC. Should two or more than two inverters upload data at the same time, then bus competition will occur, which will not only lead to communication failure, but higher current to certain elements as well.

3. Grounding and Terminal

Terminal resistance of $120\ \Omega$ will be adopted for terminal of RS485 network, to diminish the reflection of signals. Terminal resistance shall not be used for intermediate network.

No direct grounding shall be allowed for any point of RS485 network. All the equipment in the network shall be well grounded via their own grounding terminal. Please note that grounding wires will not form closed loop in any case.

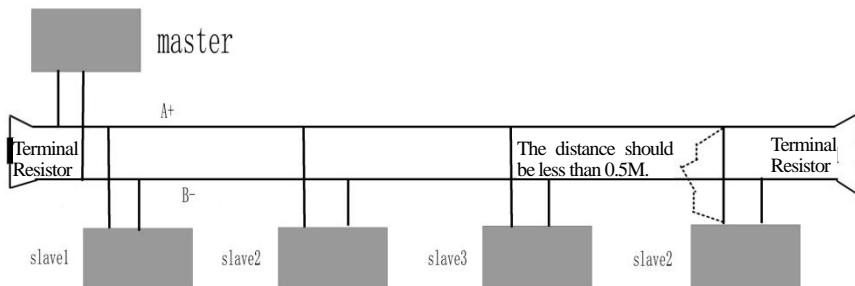

Connecting Diagram of Terminal Resistance

Please think over the drive capacity of PC/PLC and the distance between PC/PLC and inverter when wiring. Add a repeaters if drive capacity is not enough.



All wiring connections for installation shall have to be made when the inverter is disconnected from power supply.

V. Examples

Eg1: In RTU mode, change acc time (F114) to 10.0s in NO.01 inverter.

Query

Address	Function	Register Address Hi	Register Address Lo	Preset Data Hi	Preset Data Lo	CRC Lo	CRC Hi
01	06	01	0E	00	64	E8	1E

Function code F114

Value: 10.0S

Normal Response

Address	Function	Register Address Hi	Register Address Lo	Response Data Hi	Response Data Lo	CRC Lo	CRC Hi
01	06	01	0E	00	64	E8	1E

Function code F114

Normal Response

Abnormal Response

Address	Function	Abnormal code	CRC Lo	CRC Hi
01	86	04	43	A3

The max value of function code is 1. Slave fault

Eg 2: Read output frequency, output voltage, output current and current rotate speed from NO.2 inverter.

Host Query

Address	Function	First Register Address Hi	First Register Address Lo	Register count Hi	Register count L0	CRC Lo	CRC Hi
02	03	10	00	00	04	40	FA

Communication Parameters Address 1000H

Slave Response:

Address	Function	Byte Count	Data Hi	Data Lo	Data Hi	Data Lo	Data Hi	Data Lo	Data Hi	Data Lo	Crc Lo	Crc Hi
02	03	08	13	88	01	90	00	3C	02	00	82	F6

Output Frequency Output Voltage Output Current Numbers of Pole Pairs Control Mode

NO.2 Inverter's output frequency is 50.00Hz, output voltage is 400V, output current is 6.0A, numbers of pole pairs are 2 and control mode keypad control.

Eg 3: NO.1 Inverter runs forwardly.

Host Query:

Address	Function	Register Hi	Register Lo	Write status Hi	Write status Lo	CRC Lo	CRC Hi
01	06	20	00	00	01	43	CA

Communication parameters address 2000H

Forward running

Slave Normal Response:

Address	Function	Register Hi	Register Lo	Write status Hi	Write status Lo	CRC Lo	CRC Hi
01	06	20	00	00	01	43	CA

Normal Response

Slave Abnormal Response:

Address	Function	Abnormal Code	CRC Lo	CRC Hi
01	86	01	83	A0

The max value of function code is 1. Illegal function code (assumption)

Eg4: Read the value of F113, F114 from NO.2 inverter

Host Query:

Address	Function	Register Address Hi	Register Address Lo	Register Count Hi	Register Count L0	CRC Lo	CRC Hi
---------	----------	---------------------	---------------------	-------------------	-------------------	--------	--------

02	03	01	0D	00	02	54	07
----	----	----	----	----	----	----	----

Communication Parameter Address F10DH

Numbers of Read Registers

Slave Normal Response:

Address	Function	Byte count	The first parameters status Hi	The first parameters status Lo	The second parameters status Hi	The second parameters status Lo	CRC Lo	CRC Hi
02	03	04	03	E8	00	78	49	61

The actual value is 10.00.

The actual value is 12.00.

Slave Abnormal Response:

Address	Function Code	Abnormal Code	CRC Lo	CRC Hi
02	83	08	B0	F6

The max value of function code is 1.

Parity check fault

Appendix 5 Reference wiring of water system

1. Fixed mode of 1 inverter driving 2 pumps

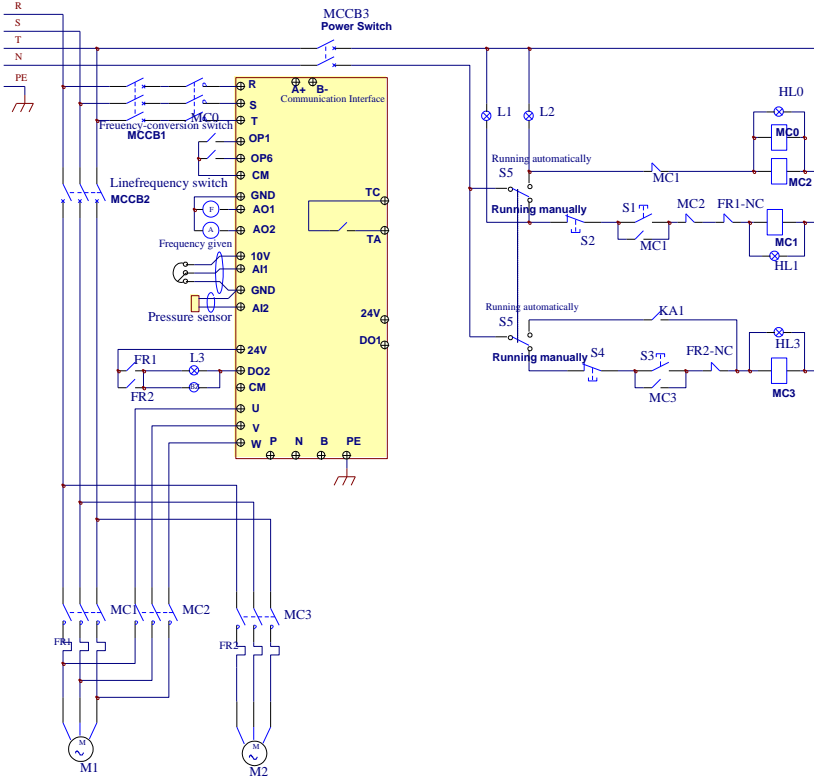

Instructions of wiring:

- Please connect the wiring according to above wiring, after checking the wiring and close MCCB3.
- Please set F208=1, F203=9, FA00=1, FA36=1, FA37=1, FA47=1, FA48=2, FA04=pressure percentage, FA03=channel limit pressure, and FA05.
- In manual status, please close power-frequency switch MCCB2. When pressing S1, pump M1 starts working. When pressing S2, M1 stops working. When pressing S3, M2 starts working. When pressing S4, M2 stops working.
- In automatic status, please close converter-frequency switch MCCB1 and power-frequency switch MCCB2.
 - When inverter is powered on, inverter will run forward by short-connecting DI3 terminal (or run reverse by short-connecting DI4 terminal), M1 will work at power frequency status.
 - If the pressure is not high enough, inverter will accelerate to max frequency. If the pressure is still not high enough after duration time FA31, inverter will free stop and pump M2 will start working at power frequency status. After the duration time of FA30, inverter will start working and M1 works at converter frequency status.
 - When two pumps work at the same time, if pressure is too high, inverter will decelerate to min frequency. If the pressure is still too high after the duration time FA32, M2 will stop working.

- If one pump M1 works at converter frequency status and inverter works at the min frequency, inverter will free stop after the duration time FA10, inverter will enter into dormancy status and nP is displayed.

2. Rotating mode of 1 inverter driving 2 pumps

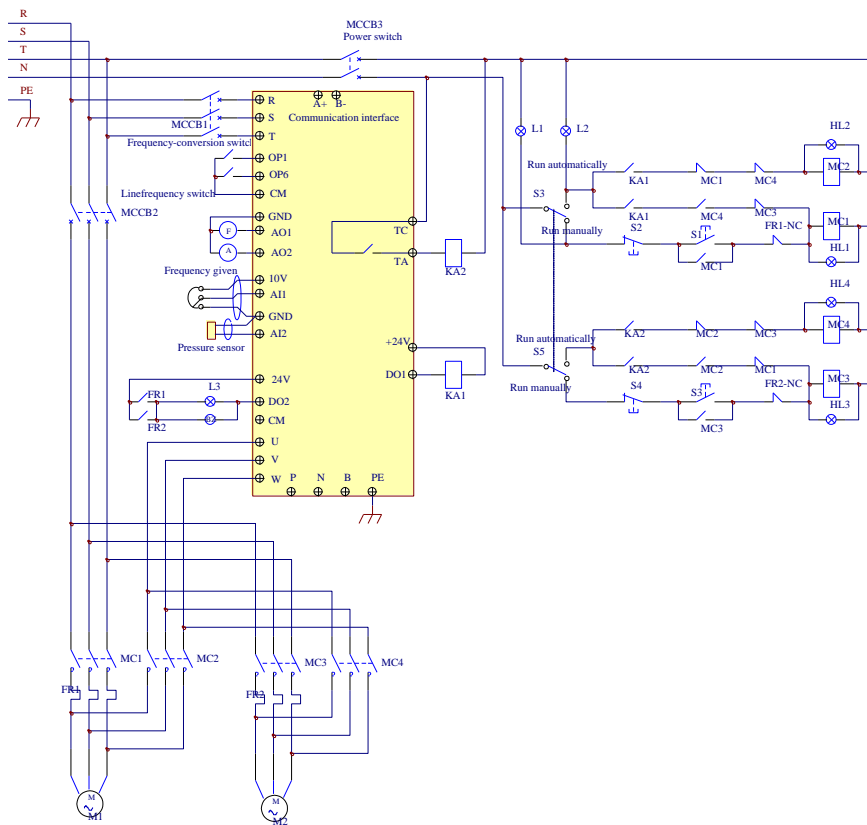

Instructions of wiring:

- (2) Please connect the wiring according to above wiring, after checking the wiring and close MCCB3.
 - (3) Please set F208=1, F203=9, FA00=2, FA36=1, FA37=1, FA47=1, FA48=2, FA04=pressure percentage, FA03=channel limit pressure, and FA05
 - (4) In manual status, please close power-frequency switch MCCB2. When pressing S1, pump M1 starts working. When pressing S2, M1 stops working. When pressing S3, M2 starts working. When pressing S4, M2 stops working.
- In automatic status, please close converter-frequency switch MCCB1 and power-frequency switch MCCB2.
 - When inverter is powered on, KA1 is "action", and inverter will run forward by short-connecting DI3 terminal, KA2 makes M1 start working at converter frequency status. If the pressure is not high enough, inverter will accelerate to max frequency. If the pressure is still not high enough after duration time FA31, inverter will free stop and pump M2 will start working at power frequency status. After the

duration time of FA30, inverter will start working and M1 works at converter frequency status.

- After the duration time FA25, all pumps will free stop, then KA2 is “action”, M2 is converter pump. If the pressure is not high enough, inverter will accelerate to max frequency. If the pressure is still not high enough after duration time FA31, inverter will free stop and KA1 makes M1 start working at power frequency status. After the duration time of FA30, inverter will start working and M2 works at converter frequency status.

- When two pumps work at the same time, if pressure is too high, inverter will decelerate to min frequency. If the pressure is still too high after the duration time FA32, general pump will stop working.

- If one pump works at converter frequency status and inverter works at the min frequency, inverter will free stop after the duration time FA10, inverter will enter into dormancy status and nP is displayed.

Appendix 6 Zoom Table of Function Code

Basic parameters: F100-F160

Function Code	Function Definition	Setting Range	Mfr's Value	Change
F100	User's Password	0~9999		√
F102	Inverter's Rated Current (A)		Subject to inverter model	○*
F103	Inverter Power (kW)		Subject to inverter model	○*
F105	Software Edition No.		Subject to inverter model	△
F106	Control mode	0: Sensorless vector control (SVC); 2: V/F; 3: Vector control 1 6: PMSM sensorless vector control	2	×
F107	Password Valid or Not	0: invalid; 1: valid	0	√
F108	Setting User's Password	0~9999	8	√
F109	Starting Frequency (Hz)	0.0~10.00	0.0	√
F110	Holding Time of Starting Frequency (S)	0.0~999.9	0.0	√
F111	Max Frequency (Hz) _v	F113~590.0	50.00	√
F112	Min Frequency (Hz)	0.00Hz~F113	0.50	√
F113	Target Frequency (Hz)	F111~F112	50.00	√
F114	1 st Acceleration Time	0.1~3000S	Subject to inverter model	√
F115	1 st Deceleration Time	0.1~3000S		√
F116	2 nd Acceleration Time	0.1~3000S		√
F117	2 nd Deceleration Time	0.1~3000S		√
F118	Turnover Frequency	1.00~590.0		50.00
F119	Reference of setting accel/decel time	0: 0~50.00 1: 0~F111	0	×
F120	Forward/Reverse Switchover dead-Time	0.0~3000	0.0	√
F122	Reverse Running Forbidden	0: invalid; 1: valid	0	×
F123	Minus frequency is valid in the mode of combined speed control.	0: Invalid; 1: valid	0	×
F124	Jogging Frequency	F112~F111	5.00	√
F125	Jogging Acceleration Time	0.1~3000	Subject to inverter model	√
F126	Jogging Deceleration Time	0.1~3000		√
F127	Skip Frequency A	0.00~590.0	0.00	√
F128	Skip Width A	0.00~2.50	0.00	√
F129	Skip Frequency B	0.00~590.0	0.00	√

F130	Skip Width B	0.00~2.50	0.00	√
F131	Running Display Items	0—Present output frequency / function code 1—Current output rotary speed 2—Output current 4—Output voltage 8—PN voltage 16—PID feedback value 32—Temperature 64—Reserved 128—Linear speed 256—PID given value 128—Linear speed 256—PID given value 2048—Output power 4096—Output torque	0+1+2+4+8=15	√
F132	Display items of stop	0: frequency / function code 1: Keypad jogging 2: Target rotary speed 4: PN voltage 8: PID feedback value 16: Temperature 32: Reserved 64: PID given value 128: Reserved 256: Reserved 512: Setting torque	2+4=6	√
F133	Drive Ratio of Driven System	0.10~200.0	1.0	√
F134	Transmission-wheel radius	0.001~1.000	0.001	√
F135	Reserved			
F136	Slip compensation	0~10	0	×
F137	Modes of torque compensation	0: Linear compensation; 1: Square compensation; 2: User-defined multipoint compensation 3: Auto torque compensation	3	×
F138	Linear compensation	1~20	Subject to inverter model	×
F139	Square compensation	1: 1.5; 2: 1.8; 3: 1.9; 4: 2.0	1	×
F140	Voltage compensation point frequency	0~F142	1.00	×
F141	Voltage compensation point 1 (%)	0~100	4	×
F142	User-defined frequency point 2	F140~F144	5.00	×
F143	User-defined voltage point 2	0~100	13	×

F144	User-defined frequency point 3	F142~F146	10.00	×
F145	User-defined voltage point 3	0~100%	24	×
F146	User-defined frequency point 4	F144~F148	20.00	×
F147	User-defined voltage point 4	0~100%	45	×
F148	User-defined frequency point 5	F146~F150	30.00	×
F149	User-defined voltage point 5	0~100%	63	×
F150	User-defined frequency point 6	F148~F118	40.00	×
F151	User-defined voltage point 6	0~100%	81	×
F152	Output voltage corresponding to turnover frequency	10~100%	100	×
F153	Carrier frequency setting	Subject to inverter model	Subject to inverter model	×
F154	Automatic voltage rectification	0: Invalid 1: Valid 2:Invalid during deceleration process	0	×
F155	Digital accessorial frequency setting	0~F111	0	×
F156	Digital accessorial frequency polarity setting	0 ~ 1	0	×
F157	Reading accessorial frequency			Δ
F158	Reading accessorial frequency polarity			Δ
F159	Random carrier-wave frequency selection	0: Control speed normally; 1: Random carrier-wave frequency	1	×
F160	Reverting to manufacturer values	0: Not reverting to manufacturer values; 1: Reverting to manufacturer values	0	×

Running control mode: F200-F230

F200	Source of start command	0: Keypad command; 1: Terminal command; 2: Keypad+Terminal; 3:MODBUS; 4: Keypad+Terminal+MODBUS	4	×
F201	Source of stop command	0: Keypad command; 1: Terminal command; 2: Keypad+Terminal; 3:MODBUS; 4: Keypad+Terminal+MODBUS	4	×
F202	Mode of direction setting	0: Forward running locking; 1: Reverse running locking; 2: Terminal setting	0	×

F203	Main frequency source X	0: Digital setting memory; 1: External analog AI1; 2: External analog AI2; 3: Reserved; 4: Stage speed control; 5: No memory by digital setting; 6: Analog AI3; 8: Reserved; 9: PID adjusting; 10: MODBUS	0	×
F204	Accessorial frequency source Y	0: Digital setting memory; 1: External analog AI1; 2: External analog AI2; 3: Reserved; 4: Stage speed control; 5: PID adjusting; 6: Analog AI3	0	×
F205	Reference for selecting accessorial frequency source Y range	0: Relative to max frequency; 1: Relative to frequency X	0	×
F206	Accessorial frequency Y range	0~100%	100	×
F207	Frequency source selecting	0: X; 1: X+Y; 2: X or Y (terminal switchover); 3: X or X+Y (terminal switchover); 4: Combination of stage speed and analog 5: X-Y 6: X+Y-Y _{MAX} *50%	0	×
F208	Terminal two-line/three-line operation control	0: No function; 1: two-line type 1; 2: two-line type 2; 3: three-line operation control 1; 4: three-line operation control 2; 5: start/stop controlled by direction pulse	0	×
F209	Selecting the mode of stopping the motor	0: stop by deceleration time; 1: free stop	0	×
F210	Frequency display accuracy	0.01~2.00	0.01	√
F211	Speed of digital control	0.01~100.00	5.00	√
F212	Direction memory	0: Invalid 1: Valid	0	√
F213	Auto-starting after repowered on	0: invalid; 1: valid	0	√
F214	Auto-starting after reset	0: invalid; 1: valid	0	√
F215	Auto-starting delay time	0.1~3000.0	60.0	√
F216	Times of auto-starting in case of repeated faults	0~5	0	√
F217	Delay time for fault reset	0.0~10.0	3.0	√
F218-	Reserved			
F219	EEPROM write operation	0: enabled to write 1: Only RAM	1	√
F220	Frequency memory after power-down	0: invalid; 1: valid	0	√
F224	When target frequency is lower than Min frequency	0: stop 1: run at min frequency	0	×
F226	Skip frequency mode	0: no action during accelerating 1: no action during decelerating 2: valid at any time		

F277	Third Acceleration Time (S)	Setting range: 0.1~3000	Subject inverter model	√
F278	Third Deceleration Time (S)			√
F279	Fourth Acceleration Time (S)			√
F280	Fourth Deceleration Time (S)			√

Multifunctional Input and Output Terminals: F300-F330

F300	Relay token output	0: no function; 1: inverter fault protection; 2: over latent frequency 1; 3: over latent frequency 2; 4: free stop; 5: inverter running status 1; 6: DC braking; 7: acceleration/deceleration time switchover; 8-9: Reserved 10: inverter overload pre-alarm; 11: motor overload pre-alarm; 12: stalling;	1	√
F301	DO1 token output	13: Inverter is ready to run 14: inverter running status 2; 15: frequency arrival output; 16: Over heat pre-alarm 17: over latent current output 18: Analog line disconnection protection 19: Under-load protection output 20: Zero current detecting output 21: OUT1 controlled by communication 22: OUT2 controlled by communication 23: TA, TC fault relay output controlled by communication	14	√
F302	DO2 token output	24: Watchdog output token 30: General pump is running 31: Converter pump is running 32: Over-limit pressure token	5	
F304	S curve beginning stage proportion	2.0~50.0	30.0	√
F305	S curve ending stage proportion	2.0~50.0	30.0	√
F306	Accel/decel mode	0: Straight-line 1: S curve	0	×
F307	Characteristic frequency 1	F112~F111	10.00	√
F308	Characteristic frequency 2	F112~F111	50.00	√
F309	Characteristic frequency width	0~100	50	√
F310	Characteristic current	0~1000	Rated current	√
F311	Characteristic current hysteresis loop width	0~100	10	√
F312	Frequency arrival threshold	0.00~5.00	0.00	√

F316	DI1 terminal function setting	0: no function; 1: running terminal; 2: stop terminal;	11	√
F317	DI2 terminal function setting	3: multi-stage speed terminal 1; 4: multi-stage speed terminal 2; 5: multi-stage speed terminal 3; 6: multi-stage speed terminal 4;	9	√
F318	DI3 terminal function setting	7: reset terminal; 8: free stop terminal;	15	√
F319	DI4 terminal function setting	9: external emergency stop terminal; 10: acceleration/deceleration forbidden terminal;	16	√
F320	DI5 terminal function setting	11: forward run jogging; 12: reverse run jogging; 13: UP frequency increasing terminal;	7	√
F321	DI6 terminal function setting	14: DOWN frequency decreasing terminal; 15: "FWD" terminal; 16: "REV" terminal;	8	√
F322	DI7 terminal function setting	17: three-line type input "X" terminal; 18: accel/decel time switchover 1; 19: Reserved;	0	√
F323	DI8 terminal function setting	20: Speed/torque switchover 21: frequency source switchover terminal; 30: Water lack signal; 31: Signal of water 32: Fire pressure switchover; 33: Emergency fire control 34: Accel / decel switchover 2 37: Common-open PTC heat protection 38: Common-close PTC heat protection 53: Watchdog 54: Frequency reset 61: Start-stop terminal	2	√
F324	Free stop terminal logic	0: positive logic (valid for low level); 1: negative logic (valid for high level)	0	×
F325	External emergency stop terminal logic		0	×
F326	Watchdog time	0: Invalid 0.1-3000	10.0	√
F327	Stop mode	0: Free to stop 1: Deceleration to stop	0	×
F328	Terminal filter times	1~100	20	√
F329	Reserved			
F330	Diagnostics of DIX terminal			√
F331	Monitoring AI1		Read only	
F332	Monitoring AI2		Read only	
F333	Monitoring AI3		Read only	
F335	Relay output simulation	Setting range:	0	×
F336	DO1 output simulation	0: Output active.	0	×
F337	DO2 output simulation	1: Output inactive.	0	×
F338	AO1 output simulation	Setting range: 0~4095	0	×
F339	AO2 output simulation	Setting range: 0~4095	0	×

F340	Selection of terminal negative logic	0: Invalid 1: DI1 negative logic 2: DI2 negative logic 4: DI3 negative logic 8: DI4 negative logic 16: DI5 negative logic 32: DI6 negative logic 64: DI6 negative logic 128: DI8 negative logic	0	√
F343	Delay time of DI1 ON	0.00~99.99	0.00	√
F344	Delay time of DI2 ON	0.00~99.99	0.00	√
F345	Delay time of DI3 ON	0.00~99.99	0.00	√
F346	Delay time of DI4 ON	0.00~99.99	0.00	√
F347	Delay time of DI5 ON	0.00~99.99	0.00	√
F348	Delay time of DI6 ON	0.00~99.99	0.00	√
F351	Delay time of DI1 OFF	0.00~99.99	0.00	√
F352	Delay time of DI2 OFF	0.00~99.99	0.00	√
F353	Delay time of DI3 OFF	0.00~99.99	0.00	√
F354	Delay time of DI4 OFF	0.00~99.99	0.00	√
F355	Delay time of DI5 OFF	0.00~99.99	0.00	√
F356	Delay time of DI6 OFF	0.00~99.99	0.00	√

Analog Input and Output: F400-F480

F400	Lower limit of AI1 channel input (V)	0.00~F402	0.04	√
F401	Corresponding setting for lower limit of AI1 input	0~F403	1.00	√
F402	Upper limit of AI1 channel input(V)	F400~10.00	10.00	√
F403	Corresponding setting for upper limit of AI1 input	0.00~2.00	2.00	√
F404	AI1 channel proportional gain K1	0.0~10.0	1.0	√
F405	AI1 filtering time constant	0.01~10.0	0.10	√
F406	Lower limit of AI2 channel input	0.00~F408	0.04	√
F407	Corresponding setting for lower limit of AI2 input	0~F409	1.00	√
F408	Upper limit of AI2 channel input	F406~10.00V	10.00	√
F409	Corresponding setting for upper limit of AI2 input	0.00~2.00	2.00	√
F410	AI2 channel proportional gain K2	0.0~10.0	1.0	√
F411	AI2 filtering time constant	0.01~10.00	0.10	√
F412	Lower limit of AI3 channel input	0.00~F414	0.05	○
F413	Corresponding setting for lower limit of AI3 input	0~F415	1.00	√
F414	Upper limit of AI3 channel input	F412~10.0	10.0	○
F415	Corresponding setting for upper limit of AI3 input	Max (1.00, F413) ~2.00	2.00	√
F416	AI3 channel proportional gain K1	0.0~10.0	1.0	√
F417	AI3 filtering time constant	0.1~10.00	0.1	√
F418	AI1 channel 0Hz voltage dead zone	0.00~1.00	0.00	√
F419	AI2 channel 0Hz voltage dead zone	0.00~1.00	0.00	√
F420	AI3 channel 0Hz voltage dead zone	0~0.50V (Positive-Negative)	0.00	√
F421	Panel selection	1: Auto switchover between remote control keypad and local keypad 2: Local keypad+ remote keypad	1	○√
F422	Potentiometer selection	0: Potentiometer in local panel 1: Potentiometer in remote control panel	0	√
F423	AO1 output range	0: 0~5V; 1: 0~10V or 0-20mA 2: 4-20mA	1	√
F424	AO1 lowest corresponding frequency	0.0~F425	0.05	√
F425	AO1 highest corresponding frequency	F424~F111	50.00	√
F426	AO1 output compensation	0~120	100	√
F427	AO2 output range	0: 0~20mA; 1: 4~20mA	0	√
F428	AO2 lowest corresponding frequency	0.0~F429	0.05	√
F429	AO2 highest corresponding frequency	F428~F111	50.00	√
F430	AO2 output compensation	0~120	100	√

F431	AO1 analog output signal selecting	0: Running frequency; 1: Output current; 2: Output voltage; 3: Analog AI1 4: Analog AI2 5: Reserved 6: Output torque 7: PC/PLC 8: Target frequency	0	√
F432	AO2 analog output signal selecting		1	√
F433	Corresponding current for full range of external voltmeter	0.01~5.00 times of rated current	2	×
F434	Corresponding current for full range of external ammeter		2	×
F435-F436	Reserved			
F437	Analog filter width	1~100	10	√
F438	Input signal of AI1 channel	Setting range: 0: voltage 1: current	0	×
F439	Input signal of AI2 channel	Setting range: 0: voltage 1: current	1	×
F460	AI1 channel input mode	0: straight line mode 1: folding line mode	0	×
F461	AI2 channel input mode	0: straight line mode 1: folding line mode	0	×
F462	AI1 insertion point A1 voltage value	F400~F464	2.00	×
F463	AI1 insertion point A1 setting value	F401~F465	1.20	×
F464	AI1 insertion point A2 voltage value	F462~F466	5.00V	×
F465	AI1 insertion point A2 setting value	F463~F467	1.50	×
F466	AI1 insertion point A3 voltage value	F464~F402	8.00	×
F467	AI1 insertion point A3 setting value	F465~F403	1.80	×
F468	AI2 insertion point B1 voltage value	F406~F470	2.00	×
F469	AI2 insertion point B1 setting value	F407~F471	1.20	×
F470	AI2 insertion point B2 voltage value	F468~F472	5.00	×
F471	AI2 insertion point B2 setting value	F469~F473	1.50	×
F472	AI2 insertion point B3 voltage value	F470~F412	8.00	×
F473	AI2 insertion point B3 setting value	F471~F413	1.80	×
F474-480	Reserved			

Multi-stage Speed Control: F500-F580

F500	Stage speed type	0: 3-stage speed; 1: 15-stage speed; 2: Max 8-stage speed auto circulating	1	×
F501	Selection of Stage Speed Under Auto-circulation Speed Control	2~8	7	√

F502	Selection of Times of Auto-Circulation Speed Control	0~9999 (when the value is set to 0, the inverter will carry out infinite circulating)	0	√
F503	Status after auto circulation running Finished	0: Stop 1: Keep running at last stage speed	0	√
F504	Frequency setting for stage 1 speed	F112~F111	5.00Hz	√
F505	Frequency setting for stage 2 speed	F112~F111	10.00Hz	√
F506	Frequency setting for stage 3 speed	F112~F111	15.00Hz	√
F507	Frequency setting for stage 4 speed	F112~F111	20.00Hz	√
F508	Frequency setting for stage 5 speed	F112~F111	25.00Hz	√
F509	Frequency setting for stage 6 speed	F112~F111	30.00Hz	√
F510	Frequency setting for stage 7 speed	F112~F111	35.00Hz	√
F511	Frequency setting for stage 8 speed	F112~F111	40.00Hz	√
F512	Frequency setting for stage 9 speed	F112~F111	5.00Hz	√
F513	Frequency setting for stage 10 speed	F112~F111	10.00Hz	√
F514	Frequency setting for stage 11 speed	F112~F111	15.00Hz	√
F515	Frequency setting for stage 12 speed	F112~F111	20.00Hz	√
F516	Frequency setting for stage 13 speed	F112~F111	25.00Hz	√
F517	Frequency setting for stage 14 speed	F112~F111	30.00Hz	√
F518	Frequency setting for stage 15 speed	F112~F111	35.00Hz	√
F519-F533	Acceleration time setting for the speeds from Stage 1 to stage 15	0.1~3000S	Subject to model	√
F534-F548	Deceleration time setting for the speeds from Stage 1 to stage 15	0.1~3000S	Subject to model	√
F549-F556	Running directions of stage speeds from Stage 1 to stage 8	0: forward running; 1: reverse running	0	√
F557-F564	Running time of stage speeds from Stage 1 to stage 8	0.1~3000S	1.0S	√
F565-F572	Stop time after finishing stages from Stage 1 to stage 8.	0.0~3000S	0.0S	√
F573-F579	Running directions of stage speeds from Stage 9 to stage 15.	0: forward running; 1: reverse running	0	√

F580	Reserved			
------	----------	--	--	--

Auxiliary Functions: F600-F670

F600	DC braking function selection	0: Invalid; 1: braking before starting; 2: braking during stopping; 3: braking during starting and stopping	0	√
F601	Initial frequency for dc braking	0.20~5.00	1.00	√
F602	DC braking current before starting	0~250 for 30kW and below 30kW 0~200 for above 30kW	50	√
F603	DC braking current during stop	0~250 for 30kW and below 30kW 0~200 for above 30kW	100	√
F604	Braking lasting time before starting	0.0~30.0	0.5	√
F605	Braking lasting time during stopping	0.0~30.0	0.5	√
F606	Reserved			
F607	Selection of stalling adjusting function	Setting range: 0~2:Reserved 3: Voltage/current control 4: Voltage control 5: Current control	3	√
F608	Stalling current adjusting	60~200	160	√
F609	Stalling voltage adjusting	110~200	Subject to model	√
F610	Stalling protection judging time	0.0~3000	0	√
F611	Dynamic Braking threshold	200~1000	Subject to model	△
F612	Dynamic braking duty ratio (%)	0~100	80	×
F613	Speed track	0: invalid 1: valid 2: valid at the first time	0	×
F614	Speed track mode	Setting range: 0: Speed track from frequency memory 1: Speed track from max frequency 2: Speed track from zero	0	×
F615	Speed track rate (%)	1~100	20	×
F616-F617	Reserved			
F618	Delay time of speed track (S)	0.5~60.0	1.5	×

F622	Dynamic braking mode	0: Fixed duty ratio 1: Auto duty ratio	1	√
F631	VDC adjustment selection	0: invalid 1: valid	0	√
F632	Target voltage of VDC adjustor (V)	200-800	Subject to model	√ ○
F638	Parameter copy function	0: forbid to copy 1: copy mode 1(rated voltage and power rating is same) 2: copy mode 2(ignore rated voltage and power rating)	1	
F639	Parameter copy code		Subject to model	△
F640	Parameter copy type	0: Copy all parameters 1: Copy parameters (except motor parameters from F801 to F810/F844)	1	×
F641	Inhibition of current oscillation at low frequency	Setting range: 0~100 0: Invalid	Subject to model	×

Timing Control and Protection: F700-F760

F700	Selection of terminal free stop mode	0: free stop immediately; 1: delayed free stop	0	√
F701	Delay time for free stop and programmable terminal action	0.0~60.0	0.0	√
F702	Fan control mode	0:controlled by temperature 1: Running when inverter is powered on 2: Controlled by running status 3: Fan runs periodically	2	×
F703	Reserved			
F704	Inverter overloading pre-alarm coefficient (%)	50~100	80	*
F705	Motor overloading pre-alarm coefficient (%)	50~100	80	*
F706	Inverter Overloading coefficient (%)	100~150	120	×
F707	Motor overloading coefficient (%)	20~100	100	×
F708	Record of The Latest Malfunction Type	2: Over current (OC) 3: over voltage (OE) 4: input phase loss (PF1) 5: inverter overload (OL1) 6: under voltage (LU) 7: overheat (OH) 8: motor overload (OL2)		△

F709	Record of Malfunction Type for Last but One	11: external malfunction (ESP) 12: current fault before running (Err3) 13. studying parameters without motor (Err2) 15: Current sampling fault (Err4) 16: Over current 1 (OC1) 17: output phase loss (PF0) 18: Analog disconnected (Aerr) 20: Under-load (EP/EP2/EP3) 22: Pressure control (nP) 23: PID parameters are set wrong (Err5) 45: Communication timeout (CE) 49: Watchdog (Err6)		Δ
F710	Record of Malfunction Type for Last but Two			Δ
F711	Fault Frequency of The Latest Malfunction			Δ
F712	Fault Current of The Latest Malfunction			Δ
F713	Fault PN Voltage of The Latest Malfunction			Δ
F714	Fault Frequency of Last Malfunction but One			Δ
F715	Fault Current of Last Malfunction but One			Δ
F716	Fault PN Voltage of Last Malfunction but One			Δ
F717	Fault Frequency of Last Malfunction but Two			Δ
F718	Fault Current of Last Malfunction but Two			Δ
F719	Fault PN Voltage of Last Malfunction but Two			Δ
F720	Record of overcurrent protection fault times			Δ
F721	Record of overvoltage protection fault times			Δ
F722	Record of overheat protection fault times			Δ
F723	Record of overload protection fault times			Δ
F724	Input phase loss	0: invalid; 1: valid	1	○×
F725	Under-voltage	1: Manual reset 2: Auto reset	2	
F726	Overheat	0: invalid; 1: valid	1	○
F727	Output phase loss	0: invalid; 1: valid	Subject to model	○
F728	Input phase loss filtering constant	0.1~60.0	0.5	√
F729	Reserved			
F730	Overheat protection filtering constant	0.1~60.0	5.0	√

F732	Voltage threshold of under-voltage protection	0~450	Subject to model	○
F737	Over-current 1 protection	0:Invalid 1: Valid	1	×
F738	Over-current 1 protection Coefficient	0.50~3.00	2.50	×
F739	Over-current 1 protection record			△
F741	Analog disconnected protection	0: Invalid 1: Stop and AErr displays. 2: Stop and AErr is not displayed. 3: Inverter runs at the min frequency. 4: Reserved.	0	√
F742	Threshold of analog disconnected protection (%)	1~100	50	√
F745	Threshold of pre-alarm overheat (%)	0~100	80	○*
F747	Carrier frequency auto-adjusting	0: Invalid 1: Valid	1	√
F753	Selection of overload protection	0: Normal motor 1: variable frequency motor	1	×
F754	Zero-current threshold (%)	0~200	5	×
F755	Duration time of zero-current	0.0~60.0	0.5	√

Motor parameters: F800-F830

F800	Motor's parameters selection	Setting range: 0: Invalid; 1: Rotating tuning.; 2: Stationary tuning	0	×
F801	Rated power (kW)	0.1~1000	Subject to model	×
F802	Rated voltage (V)	1~1300		×
F803	Rated current (A)	0.2~6553.5		×
F804	Number of motor poles	2~100	4	×
F805	Rated rotary speed (rpm)	1~30000		×
F806	Stator resistance	0.001 ~ 65.53Ω (for 30kw and below 30kw) 0.1~6553mΩ (For above 30kw)	Subject to model	×
F807	Rotor resistance	0.001 ~ 65.53Ω (for 30kw and below 30kw) 0.1~6553mΩ (For above 30kw)	Subject to model	×
F808	Leakage inductance	0.01 ~ 655.3mH (for 30kw and below 30kw) 0.001~65.53mH (for above 30kw)	Subject to model	×
F809	Mutual inductance	0.01 ~ 655.3mH (for 30kw and below 30kw) 0.001~65.53mH (for above 30kw)	Subject to model	×

F810	Motor rated frequency	1.00~590.00	50.00	×
F812	Pre-exciting time	0.00~30.00S	0.30	√
F813	Rotary speed loop KP1		Subject to inverter model	√
F814	Rotary speed loop KI1			√
F815	Rotary speed loop KP2			√
F816	Rotary speed loop KI2			√
F817	PID switching frequency 1	0~F818		√
F818	PID switching frequency 2	F817~F111		√
F844	Motor current without load	0.1~F803	Subject to model	× _o
F870	PMSM back electromotive force (mV/rpm)	0.1~999.9 (valid value between lines)		×
F871	PMSM D-axis inductance (mH)	0.01~655.35		×
F872	PMSM Q-axis inductance (mH)	0.01~655.35		×
F873	PMSM stator resistance (Ω)	0.001~65.000 (phase resistor)		×
F876	PMSM injection current without load (%)	0.0~100.0	20.0	×
F877	PMSM injection current compensation without load (%)	0.0~50.0	0.0	×
F878	PMSM cut-off point of injection current compensation without load (%)	0.0~50.0	10.0	×
F879	PMSM injection current with heavy load (%)	0.0~100.0	0.0	×
F880	PMSM PCE detection time (S)	0.0~10.0	0.2	×

Communication parameter: F900-F930

F900	Communication Address	1~255: single inverter address 0: broadcast address	1	√
F901	Communication Mode	1: ASCII 2: RTU	2	√
F902	Stop bits	1~2	2	
F903	Parity Check	0: Invalid 1: Odd 2: Even	0	√
F904	Baud Rate	0: 1200; 1: 2400; 2: 4800; 3: 9600; 4: 19200 5: 38400 6: 57600	3	√
F905	Communication timeout period	0.0~3000.0	0.0	√
F906-F930	Reserved			

PID parameters: FA00-FA80

FA00	Water supply mode	0: Single pump (PID control mode) 1: Fixed mode 2: Timing interchanging	0	×
FA01	PID adjusting target given source	0: FA04 1: AI1 2: AI2 3: AI3	0	×
FA02	PID adjusting feedback given source	1: AI1 2: AI2	1	√
FA03	Max limit of PID adjusting (%)	FA04~100.0	100.0	√
FA04	Digital setting value of PID adjusting (%)	FA05~FA03	50.0	√
FA05	Min limit of PID adjusting (%)	0.0~FA04	0.0	√
FA06	PID polarity	0: Positive feedback 1: Negative feedback	1	×
FA07	Dormancy function selection	0: Valid 1: Invalid	1	×
FA09	Min frequency of PID adjusting (Hz)	Max(F112, 0.1)~F111	5.00	√
FA10	Dormancy delay time (S)	0.0~500.0	15.0	√
FA11	Wake delay time (S)	0.0~3000.0	3.0	√
FA12	Max frequency of PID	FA09-F111	50.00	√
FA18	Whether PID adjusting target is changed	0: Invalid 1: Valid	1	×
FA19	Proportion Gain P	0.00~10.00	0.3	√
FA20	Integration time I (S)	0.1~100.0	0.3	√
FA21	Differential time D (S)	0.0~10.0	0.0	√
FA22	PID sampling period (S)	0.1~10.0	0.1	√
FA23	PID negative frequency output	0: Invalid 1: valid 2: only output negative frequency	0	√
FA24	Switching Timing unit setting	0: hour 1: minute	0	×
FA25	Switching Timing Setting	1~9999	100	×
FA26	Under-load protection mode	0: No protection 1: Protection by contactor 2: Protection by PID 3: Protection by current	0	×
FA27	Current threshold of under-load protection (%)	10~150	80	√
FA28	Waking time after protection (min)	1~3000	60	√
FA29	PID dead time (%)	0.0~10.0	2.0	√

FA30	Running Interval of restarting converter pump (S)	2.0~999.9	20.0	√
FA31	Delay time of starting general pumps (S)	0.1~999.9s	30.0	√
FA32	Delay time of stopping general pumps (S)	0.1~999.9s	30.0	√
FA36	Whether No.1 relay is started	0: Stopped 1: Started	0	×
FA37	Whether No.2 relay is started	0: Stopped 1: Started	0	×
FA47	The sequence of starting No 1 relay	1~20	20	×
FA48	The sequence of starting No 2 relay	1~20	20	×
FA58	Fire pressure given value (%)	0.0~100.0	80.0	√
FA59	Emergency fire mode	0: Invalid 1: Emergency fire mode 1 2: Emergency fire mode 2	0	√
FA60	Running frequency of emergency fire	F112~F111	50.0	√
FA62	When fire emergency control terminal is invalid	0~1	0	×
FA66	Duration time of under-load protection (S)	0~60	20	√
FA67- FA80	Reserved			

Torque control parameters: FC00-FC40

FC00	Speed/torque control selection	0: Speed control 1: Torque control 2: Terminal switchover	0	√
FC02	Torque accel/decel time (S)	0.1~100.0	1.0	√
FC03- FC05	Reserved			
FC06	Torque given channel	0: Digital given (FC09) 1: Analog input AI1 2: Analog input AI2 3: Analog input AI3 4, 5: Reserved	0	×
FC07	Torque given coefficient	0~3.000	3.000	×
FC08	Reserved			
FC09	Torque given command value (%)	0~300.0	100.0	√
FC14	Offset torque given channel	0: Digital given (FC17) 1: Analog input AI1 2: Analog input AI2 3: Analog input AI3 4,5: Reserved	0	×
FC15	Offset torque coefficient	0~0.500	0.500	×
FC16	Offset torque cut-off frequency (%)	0~100.0	10.00	×

FC17	Offset torque command value (%)	0~50.0	10.00	√
FC22	Forward speed limited channel	0: Digital given (FC23) 1: Analog input AI1 2: Analog input AI2 3: Analog input AI3 4,5: Reserved	0	×
FC23	Forward speed limited (%)	0~100.0	10.00	√
FC24	Reverse speed limited channel	0: Digital given (FC25) 1: Analog input AI1 2: Analog input AI2 3: Analog input AI3 4,5: Reserved	0	×
FC25	Reverse speed limited (%)	0~100.0	10.0	√
FC26- FC27	Reserved			
FC28	Electric torque limited channel	0: Digital given (FC30) 1: Analog input AI1 2: Analog input AI2 3: Analog input AI3 4,5: Reserved	0	×
FC29	Electric torque limited coefficient	0~3.000	3.000	×
FC30	Electric torque limited (%)	0~300.0	200.0	√
FC31	Reserved			
FC32	Reserved			
FC33	Braking torque limited channel	0: Digital given (FC35) 1: Analog input AI1 2: Analog input AI2 3: Analog input AI3 4,5: Reserved	0	×
FC34	Braking torque limited coefficient	0~3.000	3.000	×
FC35	Braking torque limited (%)	0~300.0	200.00	√
FC36- FC40	Reserved			

Note: × indicating that function code can only be modified in stop state.

√ indicating that function code can be modified both in stop and run state.

△ indicating that function code can only be checked in stop or run state but cannot be modified.

○ indicating that function code cannot be initialized as inverter restores manufacturer's value but can only be modified manually.

Appendix 7 Input filter model and dimension

1. Input filter model

Inverter model	Filter mode	Remarks	
E800-0002S2	FN2060-6-06	1-phase plastic housing	
E800-0004S2	FN2060-6-06		
E800-0005S2	FN2060-10-06		
E800-0007S2	FN2060-10-06		
E800-0011S2	FN2060-20-06		
E800-0015S2	FN2060-20-06		
E800-0022S2	FN2060-20-06		
E800-0007T2	FN3258-7-44	3-phase 220V plastic housing	
E800-0015T2	FN3258-16-44		
E800-0022T2	FN3258-16-44		
E800-0002T3	FN3258-7-44	3-phase 380V plastic housing	
E800-0004T3	FN3258-7-44		
E800-0005T3	FN3258-7-44		
E800-0007T3	FN3258-7-44		
E800-0011T3	FN3258-7-44		
E800-0015T3	FN3258-7-44		
E800-0022T3	FN3258-16-44		
E800-0030T3	FN3258-16-44		
E800-0040T3	FN3258-16-44		
E800-0055T3	FN3258-16-44		
E800-0075T3	FN3258-42-33		
E800-0110T3	FN3258-42-33		
E800-0150T3	FN3258-42-33		
E800-0185T3	FN3258-55-34		
E800-0220T3	FN3258-55-34		
E800-0300T3	FN3258-75-34		
E800-0370T3	FN3258-100-35		
E800-0450T3	FN3258-100-35		
E800-0550T3	FN3359-180-28		3-phase 380V metal housing
E800-0750T3	FN3359-180-28		
E800-0900T3	FN3359-250-28		
E800-1100T3	FN3359-250-28		
E800-1320T3	FN3359-320-28		
E800-1600T3	FN3359-400-99		
E800-1800T3	FN3359-400-99		

2. Dimension

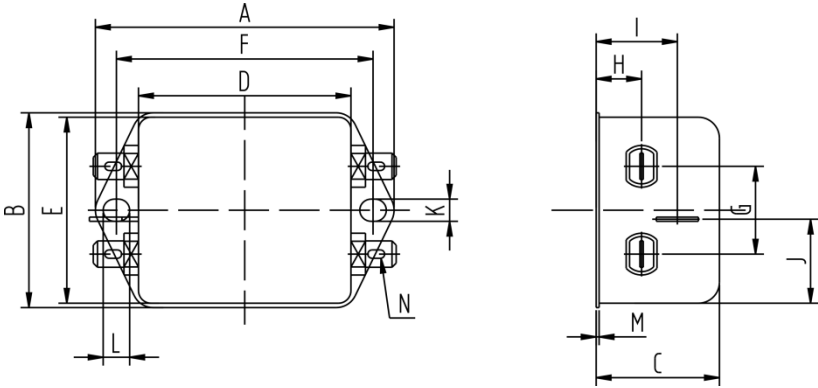

1) FN2060 dimension and installation

Model	FN2060-6-06	FN2060-10-06	FN2060-20-06
A	71	85	113.5±1
B	46.6	54	57.5±1
C	29.3	30.3	45.4±1
D	50.5	64.8	94±1
E	44.5	49.8	56
F	61	75	103
G	21	27	25
H	10.8	12.3	12.4
I	19.3	20.8	32.4
J	20.1	19.9	15.5
K	5.3	5.3	4.4
L	6.3	6.3	6
M	0.7	0.7	0.9
N	6.3×0.8		

2) FN3258 dimension and installation

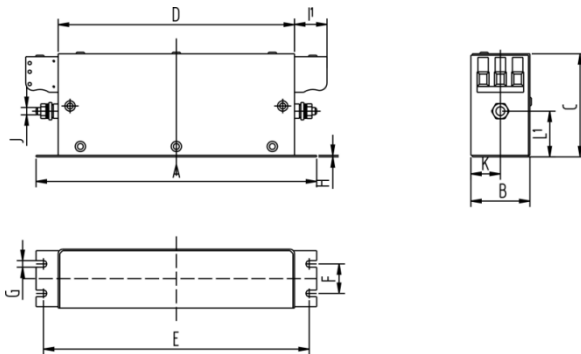

Model	FN3258-7 -44	FN3258-16 -44	FN3258-42 -33	FN3258-55 -34	FN3258-75 -34	FN3258-100 -35
A	190	250	310	250	270	270
B	40	45	50	85	80	90
C	70	70	85	90	135	150
D	160	220	280	220	240	240
E	180	235	295	235	255	255
F	20	25	30	60	60	65
G	4.5	5.4	5.4	5.4	6.5	6.5
H	1	1	1	1	1.5	1.5
II	22	22	25	39	39	45
J	M5	M5	M6	M6	M6	M10
K	20	22.5	25	42.5	40	45
L1	29.5	29.5	37.5	26.5	70.5	64

3) FN3359 dimension and installation

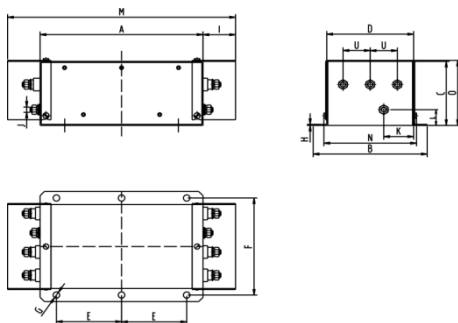

Model	FN3359-180-28	FN3359-250-28
A	300	300
B	210	230
C	120	125
D	160	180
E	120	120
F	185	205
G	φ12	φ12
H	2	2
I	33	33
J	M10	M10
K	55	62.5
L	30	35
M	420	420
N	171	191
O	127	132
U	50	55

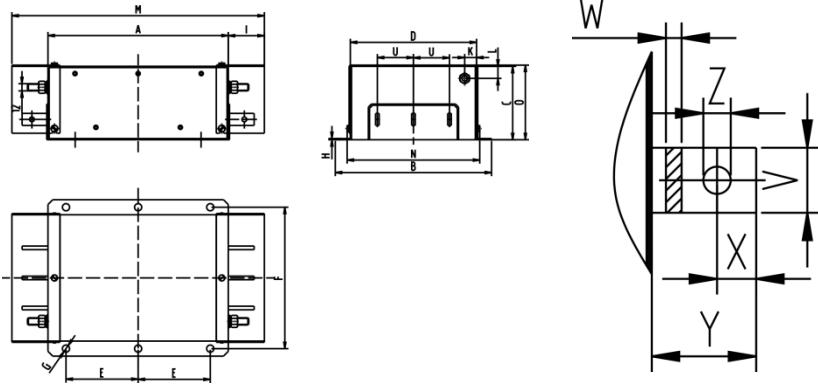

Model	FN3359-320-28	FN3359-400-99
A	300	300
B	260	260
C	115	115
D	210	210
E	120	120
F	235	235
G	φ12	φ12
H	2	2
I	43	43
J	M12	M12
K	20	20
L	20	20
M	440	440
N	221	221
O	122	122
U	60	60
V	25	25
W	6	6
X	15	15
Y	40	40
Z	φ10.5	φ10.5

Note:

1. E800 series inverter without built-in filter satisfies the CE requirements only with an EMC filter installed on the power input side.
2. When frequency inverter model does not include R3, the customer should select above options. There is no external filter for 200kw and above 200kw AC drive; they can satisfies the CE requirements.

2020011016A